

FireLock® V49, K22.4

Model V4902 Early Suppression Fast Response (ESFR)



40.92



1.0 PRODUCT DESCRIPTION

Style: Pendent

Nominal Orifice Size: 1"/25 mm

Nominal Connection Size: 1"/25 mm IGS™ Grooved, reference [publication 10.65](#).

K-Factor: 22.4 Imp./32.0 S.I.¹

Maximum Operating Pressure: Up to 175 psi/1200 kPa/12 bar

Factory Hydrostatic Test: 100% @ 500 psi/3450 kPa/34 bar

Minimum Working Pressure: As per local codes and commodity requirements.

Temperature Rating: See "Approved Temperature Ratings F°/C°" table in section 2.0

Application: See "Commodity Selection and Design Criteria Overview" table in section 2.0

Codes and Requirements: For coverage area and sprinkler placement, refer to NFPA 13, or any applicable local requirements

¹ For K-Factor when pressure is measured in Bar, multiply S.I. units by 10.

ALWAYS REFER TO ANY NOTIFICATIONS AT THE END OF THIS DOCUMENT REGARDING PRODUCT INSTALLATION, MAINTENANCE OR SUPPORT.

System No.		Location	
Submitted By		Date	

Spec Section		Paragraph	
Approved		Date	



2.0 CERTIFICATION/LISTINGS

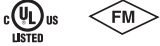

APPROVALS/LISTINGS			
Model	V4902		
Nominal K Factor Imperial	22.4		
Nominal K Factor S.I.²	32.0		
Response	Fast		
Deflector Type	Pendent		
Agency	Approved Temperature Ratings F°/C°	Maximum Exposure Temperature F°/C°	Marking Color
cULus	165/73	100/38	Uncolored/Black
	212/100	150/65	White
FM	165/73	100/38	Uncolored/Black
	212/100	150/65	White

² For K-Factor when pressure is measured in Bar, multiply S.I. units by 10.

COMMODITY SELECTION AND DESIGN CRITERIA OVERVIEW FOR MODEL V4902 ESFR PENDENT SPRINKLER	
Storage Type	NFPA
Sprinkler Type	ESFR
Response Type	ESFR
System Type	Wet
Temperature Rating °F (°C)	165 °F (73 °C), 212 °F (100 °C)
Open Frame (that is, no solid shelves) Single, Double, Multiple-Row, or Portable Rack Storage of Class I-IV and Group A or B Plastics	Refer to NFPA 13
Solid Pile or Palletized Storage of Class I-IV and Group A or B Plastics	Refer to NFPA 13
Idle Pallet Storage	Refer to NFPA 13
Rubber Tire Storage	Refer to NFPA 13
Rolled Paper Storage (Refer to the standard.)	Refer to NFPA 13
Flammable Liquid Storage (Refer to the standard.)	Refer to NFPA 30
Aerosol Storage (Refer to the standard.)	Refer to NFPA 30B
Automotive Components in Portable Racks (Control mode only, refer to the standard.)	Refer to NFPA 13

3.0 SPECIFICATIONS – MATERIAL

- Frame:** Cast brass
- Deflector:** Brass
- Compression Screw:** Stainless steel
- Hook:** Monel
- Strut:** Monel
- Link Assembly:** Nickel
- Button:** Brass
- Sealing Assembly:** Beryllium Nickel with Teflon³
- Sprinkler Finishes:** Plain Brass

³ Teflon is a registered trademark of Dupont Co.

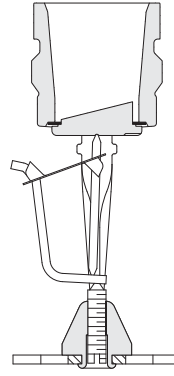

Exaggerated for clarity

4.0 DIMENSIONS



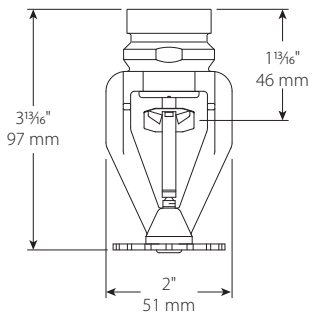

Model V4902



5.0 PERFORMANCE

COMMODITY SELECTION AND DESIGN CRITERIA OVERVIEW FOR MODEL V4902 ESFR		
Description	Specification UL	Specification FM
Sprinkler Type	ESFR	Quick Response Storage Sprinkler
Temperature Rating °F (°C)	165 °F (73 °C), 212 °F (100 °C)	165 °F (73 °C), 212 °F (100 °C)
Response Type	ESFR	Quick Response
Sprinkler Position	Pendent, frame arms aligned with pipe, deflectors parallel with ceiling or roof	Pendent
System Type	Wet	Wet
Maximum Area of Coverage	100 ft ² (30.5 m ²)	100 ft ² (30.5 m ²)
Minimum Area of Coverage	64 ft ² (19.5 m ²)	64 ft ² (19.5 m ²)
Maximum Slope Ceiling	2 unit rise for 12 unit run	2 unit rise for 12 unit run
Maximum Spacing	10 ft (3.1 m)	12 ft (3.6 m) for up to 30 ft (9.1 m) ceiling 10 ft (3.1 m) for over 30 ft (9.1 m) ceiling
Minimum Spacing	8 ft (2.4 m)	8 ft (2.4 m)
Deflector Distance from Walls	Minimum of 4 (100 mm) inches from walls but no more than ½ the allowable distance permitted between sprinklers	Minimum of 4 (100 mm) inches from walls but no more than ½ the allowable distance permitted between sprinklers
Deflector to Top of Storage	Minimum of 36 inches (0.9 m)	Minimum of 36 inches (0.9 m)
Deflector to Ceiling Distance	6 to 18 inches (152 mm to 457 mm)	Smooth Ceilings: 2 to 17 inches (51 mm to 425 mm) Non-smooth Ceilings: 4 to 17 inches (102 mm to 425 mm) to center of thermal element.
Maximum Ceiling Height	45 ft (13.7 m)	45 ft (13.7 m)
Maximum Storage Height	40 ft (12.2 m)	40 ft (12.2 m)
Storage Arrangement	Palletized, solid piled, open frame; single row, double row, or multiple row and portable rack arrangement	Palletized, solid piled, open frame; single row, double row, or multiple row and portable rack arrangement
Commodity	Class I-IV, Cartoned unexpanded plastics, cartoned expanded plastics, uncartoned unexpanded plastics, uncartoned expanded plastics	Class I-IV, Cartoned unexpanded plastics, cartoned expanded plastics, uncartoned unexpanded plastics, uncartoned expanded plastics
Sprinkler System Design	12 A.S @ approved pressures	12 A.S @ approved pressures
Obstruction Criteria	Reference NFPA 13	As per FM Data Sheet 2-0
Minimum Aisle Width	4 ft (1.2 m)	4 ft (1.2 m)
Hose Stream Allowance and Water Supply Duration	250 gpm for 60 minutes or as determined by the approval (950 lpm for 60 minutes)	250 gpm for 60 minutes or as determined by the approval (950 lpm for 60 minutes)

6.0 NOTIFICATIONS

 WARNING	
  	<ul style="list-style-type: none"> Always read and understand installation, care, and maintenance instructions, supplied with each box of sprinklers, before proceeding with installation of any sprinklers. Always wear safety glasses and foot protection. Depressurize and drain the piping system before attempting to install, remove, or adjust any Victaulic piping products. Installation rules, especially those governing obstruction, must be strictly followed. Painting, plating, or any re-coating of sprinklers (other than that supplied by Victaulic) is not allowed. <p>Failure to follow these instructions could result in serious personal injury and/or property damage.</p> <p>The owner is responsible for maintaining the fire protection system and devices in proper operating condition. For minimum maintenance and inspection requirements, refer to the current National Fire Protection Association pamphlet that describes care and maintenance of sprinkler systems. In addition, the authority having jurisdiction may have additional maintenance, testing, and inspection requirements that must be followed.</p> <p>If you need additional copies of this publication, or if you have any questions about the safe installation of this product, contact Victaulic World Headquarters: P.O. Box 31, Easton, Pennsylvania 18044-0031 USA, Telephone: 001-610-559-3300.</p>

7.0 REFERENCE MATERIALS

- [10.65: FireLock IGS Installation-Ready Style V9 Sprinkler Coupling](#)
- [25.14: Victaulic IGS Groove Specifications](#)
- [I-40: Victaulic FireLock Automatic Sprinklers Installation and Maintenance Guide](#)
- [I-V9: Style V9 Victaulic FireLock™ IGS™ Installation-Ready™ Sprinkler Coupling](#)

User Responsibility for Product Selection and Suitability

Each user bears final responsibility for making a determination as to the suitability of Victaulic products for a particular end-use application, in accordance with industry standards and project specifications, and the applicable building codes and related regulations as well as Victaulic performance, maintenance, safety, and warning instructions. Nothing in this or any other document, nor any verbal recommendation, advice, or opinion from any Victaulic employee, shall be deemed to alter, vary, supersede, or waive any provision of Victaulic Company's standard conditions of sale, installation guide, or this disclaimer.

Intellectual Property Rights

No statement contained herein concerning a possible or suggested use of any material, product, service, or design is intended, or should be construed, to grant any license under any patent or other intellectual property right of Victaulic or any of its subsidiaries or affiliates covering such use or design, or as a recommendation for the use of such material, product, service, or design in the infringement of any patent or other intellectual property right. The terms "Patented" or "Patent Pending" refer to design or utility patents or patent applications for articles and/or methods of use in the United States and/or other countries.

Note

This product shall be manufactured by Victaulic or to Victaulic specifications. All products to be installed in accordance with current Victaulic installation/assembly instructions. Victaulic reserves the right to change product specifications, designs and standard equipment without notice and without incurring obligations.

Installation

Reference should always be made to the Victaulic installation handbook or installation instructions of the product you are installing. Handbooks are included with each shipment of Victaulic products, providing complete installation and assembly data, and are available in PDF format on our website at www.victaulic.com.

Warranty

Refer to the Warranty section of the current Price List or contact Victaulic for details.

Trademarks

Victaulic and all other Victaulic marks are the trademarks or registered trademarks of Victaulic Company, and/or its affiliated entities, in the U.S. and/or other countries.