

PM / PT



PRESSURE SWITCHES FOR WATER SYSTEM APPLICATIONS PM/5 - PT/5 PM/ 6 - PT/6 PM/12 - PT/12

- Pressure switches for use with water in **autoclave systems**
- The switch ensures automatically the starting and stopping of the electric pump according to the set pressure values
- Electric contacts: normally closed and made of brass alloy with Ag-Ni surfacing
- Terminals with M4 screws and 8x8 mm pressure dice
- NBR rubber membrane with textile insert (food grade for PM/5 - PM/6 - PT/5)
- ¼" F hydraulic connection made of galvanized steel
- Standard protection degree IP 44
- Max ambient temperature: 55°C
- Tear resistant cable clamps

APPLICATIONS: Pressure switches for firefighting systems,
Pressure switches for water pumps



TECHNICAL DATA

	PM/5	PM/6	PM/12	PT/5	PT/6	>PT/12
Pressure range:	1 - 4,8 bar	1,5 - 5,5 bar	3 - 12 bar	1 - 4,8 bar	1,5 - 5,5 bar	3 - 12 bar
Factory setting:	1,4 - 2,8 bar	1,8 - 3 bar	5 - 7 bar	1,4 - 2,8 bar	1,8 - 3 bar	5 - 7 bar
Min differential:	0,6 bar	0,8 bar	1,5 bar	0,6 bar	0,8 bar	1,5 bar
Max differential:	2,3 bar	2,2 bar	5 bar	2,3 bar	2,2 bar	5 bar
Rated current:	16A (10)A	16A (10)A	16A (10)A	16A (10)A	16A (10)A	16A (10)A
Rated voltage:	250V	250V	250V	500V	500V	500V

DRAWINGS

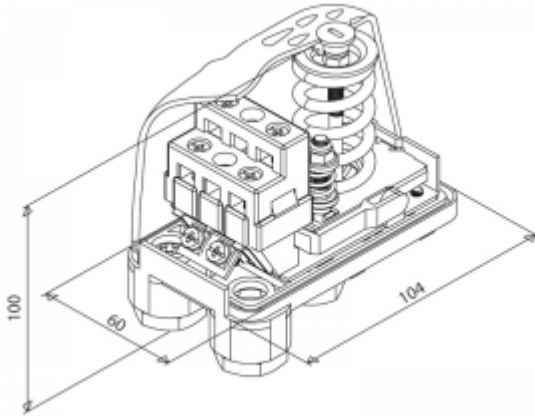

Dimensions

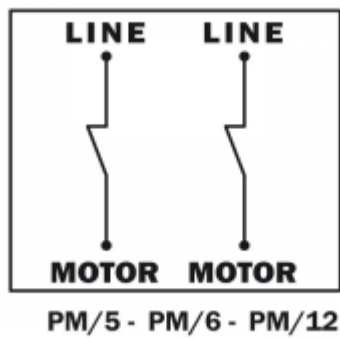

Contacts arrangement PM

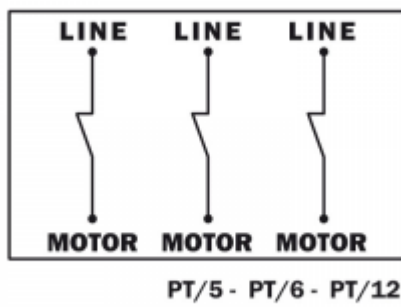

Contacts arrangement PT

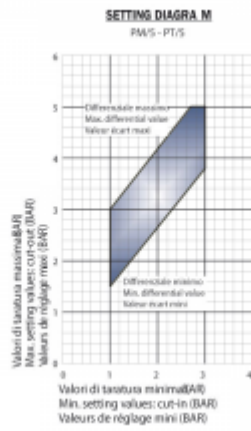

Seeting diagram PM5/PT5

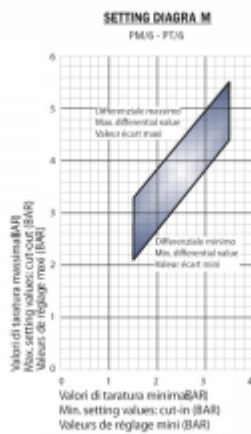

Seeting diagram PM6/PT6

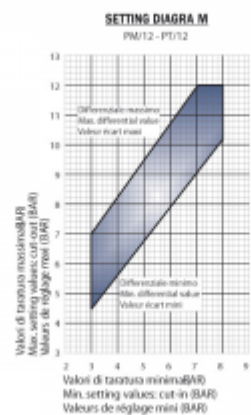

Seeting diagram PM12/PT12

ATTACH

1/4" M GAS

Male

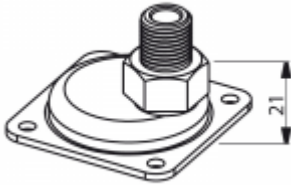

1/4" ML GAS

Long male

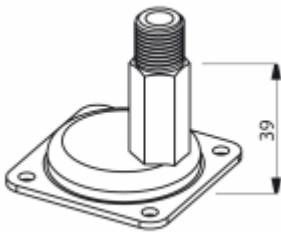

1/4" MF GAS

Long male

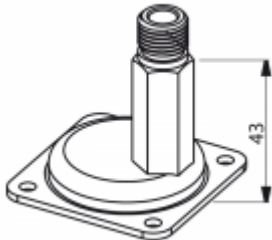

1/4" L GAS

Side male

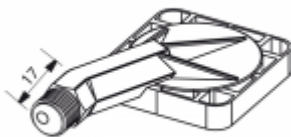

1/4" F GAS

Female

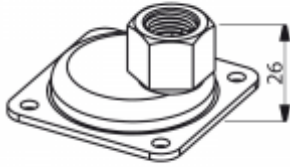

1/4" FL GAS

Long female

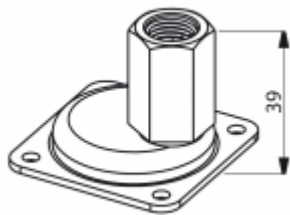

1/4" FG GAS

Female revolving nut



1/4" 4V

GAS Female - 4 ways

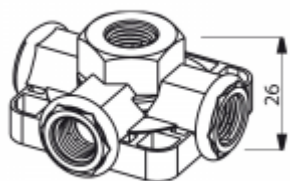

1/2" M GAS

Male

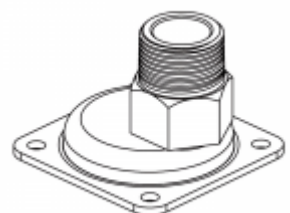

1/2" F GAS

Female

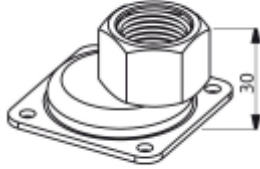

1/2" 2V

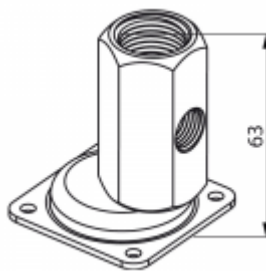

1 way 1/2" + 1 way 1/4" Female

3/8" FG GAS

Female revolving nut

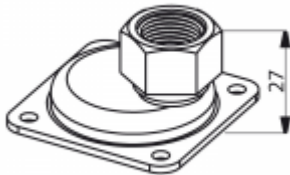

3/8" 4V

3 ways 1/4" + 1 way 3/8" Female

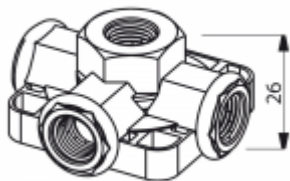

OPTIONAL

Electrical cables for motor and line connection



Version with electrical cables for motor and line connection

Customized settings



Customized settings

Special springs for not standard adjustment ranges



Special springs for not standard adjustment ranges

Graduated scale



Graduated scale on the device for an easy adjustment of their cut-in pressure

Transparent cover



Transparent cover

Cover with on/off button



Cover with **on/off** button

Reinforced electric contacts up to 20A current



Reinforced electric contacts up to **20A** current

Protection degree IP54



Protection degree IP54

Blind cable clamps



One of the two cable clamps can be supplied blind



Any unauthorized reproduction or distribution of this document is forbidden. Italtecnica reserves the right to bring without notice any modification on technical data described in the present document. Italtecnica is not liable for any possible mistakes or omissions of the content.