

# Motor circuit-breakers TeSys GV2, GV3 and GV7

Catalogue  
July

# 06



*Simply Smart !*

telemecanique.com



This international site allows you to access all the Telemecanique products in just 2 clicks via comprehensive range data-sheets, with direct links to:

- Complete library: technical documents, catalogs, certificates, FAQs, brochures...
- Selection guides from the e-catalog.
- Product discovery sites and their Flash animations.

You will also find illustrated overviews, news to which you can subscribe, a discussion forum, the list of country contacts...

To live automation solutions every day!



### *Flexibility*

- Interchangeable modular functions, to better meet the requirements for extensions
- Software and accessories common to multiple product families



### *Ingenuity*

- Auto-adapts to its environment, "plug & play"
- Application functions, control, communication and diagnostics embedded in the products
- User-friendly operation either directly on the product or remotely



### *Simplicity*

- Cost effective "optimum" offers that make selection easy for most typical applications
- Products that are easy to understand for users, electricians and automation specialists
- User-friendly intuitive programming



### *Compactness*

- High functionality in a minimum of space
- Freedom in implementation



### *Openness*

- Compliance with field bus, connection, and software standards
- Enabling decentralised or remote surveillance via the web with Transparent Ready products

# Motor circuit-breakers TeSys GV2, GV3 and GV7

---

## Thermal-magnetic circuit-breakers

**Selection guide** ..... pages 2 and 3

- Presentation ..... pages 6 and 7
- Characteristics ..... pages 8 to 13
- Curves ..... pages 24 to 36
- References ..... pages 46 to 51
- Dimensions, mounting ..... pages 66 to 71
- Schemes ..... pages 72 and 73

## Magnetic circuit-breakers

**Selection guide** ..... pages 4 and 5

- Characteristics ..... pages 14 to 17
- Curves ..... pages 37 to 45
- References ..... pages 52 and 53
- Dimensions, mounting ..... pages 74 to 76
- Schemes ..... page 77

## Enclosed circuit-breakers

- References, dimensions, mounting ..... pages 78 to 85

## Substitution table

- Old / new references ..... page 86

Applications

Protection of motors against short-circuits and overloads



Tripping threshold on short-circuit

13 In

Standard motor power ratings in AC-3, 415 V

Up to 15 kW

Up to 30 kW

37 kW

Operational current at 415 V

0.1...32 A

9...65 A

56...80 A

Breaking capacity at 415 V (Icu) to IEC 60947-2

10...100 kA

35...100 kA

50...100 kA

15 kA

Door interlock mechanism

Without

With

Without

Without

Circuit-breaker type

GV2 ME

GV2 P

GV3 P

GV3 ME80

Pages

24508/2 and 24508/3

24508/4

24508/4

24508/4

Protection of motors with high current peak on starting



7.5...110 kW

12...220 A

35 and 36 kA

With

GV7 RE

24508/5

70 kA

GV7 RS

20 In

Up to 11 kW

0.25...23 A

15...100 kA

With

GV2 RT

24508/6 and 24508/7

**Applications**

**Protection of motors**

Magnetic circuit-breakers provide short-circuit protection. They must be combined with thermal overload relays to provide motor overload protection.



**Tripping threshold on short-circuit**

13 I<sub>n</sub>

**Standard motor power ratings in AC-3, 415 V**

Up to 15 kW

**Operational current at 415 V**

0.4...32 A

**Breaking capacity at 415 V (I<sub>cu</sub>) to IEC 60947-2**

10...100 kA

35...100 kA

**Door interlock mechanism**

With

**Circuit-breaker type**

GV2 LE

GV2 L

**Pages**

24522/2

24522/3

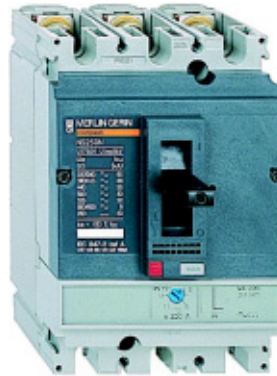

		6...14 In	8...13 In	6.3...12.5 In
Up to 30 kW	37 kW	0.37...250 kW		
25...65 A	80 A	1.5...500 A		
50...100 kA	35 kA	25.7 and 150 kA	35.7...150 kA	45.7...150 kA
Without	With	With		
<b>GV3 L</b>	<b>GK3 EF80</b>	<b>NS 80</b>	<b>NS 100 to NS 250</b>	<b>NS 400 and NS 630</b>
24522/3	24522/3	Please consult the Merlin Gerin catalogue - Low Voltage Distribution		

# TeSys protection components

## Thermal-magnetic motor circuit-breakers

### GV2, GV3 and GV7

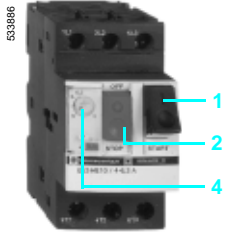

GV2 ME  
with screw clamp  
terminals

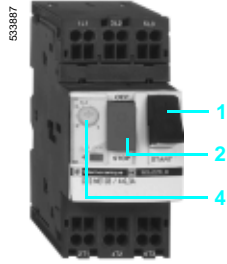

GV2 ME  
with spring terminals  
connections

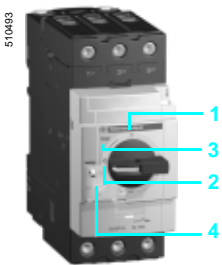

GV3 P

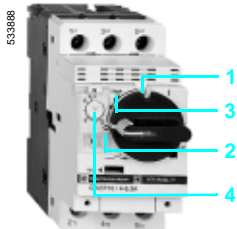

GV2 P

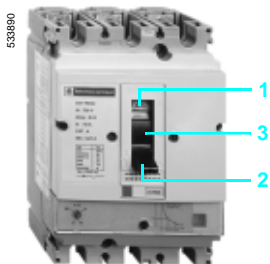

GV7 R

#### Presentation

GV2 ME, GV2 P, GV3 ME, GV3 P and GV7 R motor circuit-breakers are 3-pole thermal-magnetic circuit-breakers **specifically designed for the control and protection of motors**, conforming to standards IEC 60947-2 and IEC 60947-4-1.

#### Connection

##### GV2

GV2 ME and GV2 P circuit-breakers are designed for connection by screw clamp terminals. Circuit-breaker GV2 ME can be supplied with lugs or spring terminal connections. Spring terminal connections ensure secure, permanent and durable clamping that is resistant to harsh environments, vibration and impact and are even more effective when conductors without cable ends are used. Each connection can take two independent conductors.

##### GV3

GV3 circuit-breakers feature connection by BTR screws (hexagon socket head), tightened using a n° 4 Allen key. This type of connection uses the **EverLink®** system with creep compensation (1) (Schneider Electric patent). This technique makes it possible to achieve accurate and durable tightening torque, in order to avoid cable creep.

GV3 circuit-breakers are also available with connection by lugs. This type of connection meets the requirements of certain Asian markets and is suitable for applications subject to strong vibration, such as railway transport.

##### GV7

GV7 circuit-breakers: with connection by screw clamp terminals (for bars and lugs) and by clip-on connectors.

#### Operation

Control is manual and local when the motor circuit-breaker is used on its own. Control is automatic and remote when it is associated with a contactor.

##### GV2 ME and GV3 ME80

Pushbutton control.  
Energisation is controlled manually by operating the Start button "I" **1**.  
De-energisation is controlled manually by operating the Stop button "O" **2**, or automatically by the thermal-magnetic protection elements or by a voltage trip attachment.

##### GV2 P, GV3 P and GV7 R

- Control by rotary knob: for GV2 P and GV3 P
- Control by rocker lever: for GV7 R.

Energisation is controlled manually by moving the knob or rocker lever to position "I" **1**.  
De-energisation is controlled manually by moving the knob or rocker lever to position "O" **2**.  
De-energisation due to a fault automatically places the knob or rocker lever in the "Trip" position **3**.  
Re-energisation is possible only after having returned the knob or rocker lever to position "O".

(1) Creep: normal crushing phenomenon of copper conductors, that is accentuated over time.



# TeSys protection components

## Thermal-magnetic motor circuit-breakers GV2, GV3 and GV7

### Presentation (continued)

#### Protection of motors and personnel

Motor protection is provided by the thermal-magnetic protection elements incorporated in the motor circuit-breaker.

The **magnetic** elements (short-circuit protection) have a non-adjustable tripping threshold, which is equal to 13 times the maximum setting current of the thermal trips.

The **thermal** elements (overload protection) include automatic compensation for ambient temperature variations.

The rated operational current of the motor is displayed by means of a graduated knob 4. Personnel protection is also provided. All live parts are protected against direct finger contact from the front panel.

The addition of an undervoltage trip allows the circuit-breaker to be de-energised in the event of an undervoltage condition. The user is therefore protected against sudden starting of the machine when normal voltage is restored, since the Start button "I" has to be pressed to restart the motor.

With the addition of a shunt trip, de-energisation of the unit can be remotely controlled.

The operators on both open-mounted and enclosed motor circuit-breakers can be locked in the Stop position "O" by up to 4 padlocks.

Because they are suitable for isolation, these circuit-breakers, in the open position, provide an adequate isolation distance and indicate the actual position of the moving contacts by the position of the operators.

#### Special features

These motor circuit-breakers are easily installed in any configuration thanks to their universal fixing arrangement: screw fixing or clip-on mounting on symmetrical, asymmetrical or combination rails.

### Environment

Circuit-breaker type			GV2 ME	GV2 P	GV3 P	GV3 ME80	GV7 R
Conforming to standards			IEC 60947-1, 60947-2, 60947-4-1, EN 60204, UL 508, CSA C 22.2 n° 14-05, NF C 63-650, 63-120, 79-130, VDE 0113, 0660		IEC/EN 60947-1, 60947-2, 60947-4-1, UL 508 type E, CSA C 22.2 n° 14-05 type E	IEC/EN, NF EN, BS EN, DINEN60947-2, 60947-4-1	IEC 60947-1, 60947-2, 60947-4-1, EN 60947-1, 60947-2, EN 60947-4-1, NF C 63-650, NF C 63-120, 79-130, VDE 0113, 0660
Product certifications			UL, CSA, CCC, CEBEC, GOST, TSE, BV, GL, LROS, DNV, PTB, EZU, SETI, RINA, ATEX (pending)	UL (1), CSA, PTB, EZU, GOST, TSE, DNV, LROS, GL, BV, RINA, CCC, ATEX (pending)	UL, CSA, CCC, GOST, ATEX (pending)	UL, CSA, LROS	UL, DNV, CCC
Protective treatment			"TH"		"TH"	"TC"	"TC"
Degree of protection	Conforming to IEC 60529	Open mounted	IP 20		IP 20	IP 20	IP 405 with terminal shrouds
		In enclosure	GV2 M●01: IP 41 GV2 M●02: IP 55	–	GV3 PC01, GV3 PC02: IP 65	GV3 CE01: IP 55	–
Shock resistance	Conforming to IEC 60068-2-27	30 gn -11 ms			On: 15 gn -11 ms Off: 30 gn -11 ms	22 gn - 20 ms	30 gn -11 ms
Vibration resistance	Conforming to IEC 60068-2-6	5 gn (5...150 Hz)			5 gn (5...300 Hz)	2.5 gn (0...25 Hz)	2.5 gn (25 Hz)
Ambient air temperature	Storage	°C	- 40...+ 80	- 40...+ 80	- 40...+ 80	- 40...+ 80	- 55...+ 95
	Operation	Open mounted	°C	- 20...+ 60	- 20...+ 60	- 20...+ 60 (2)	- 20...+ 60
In enclosure		°C	- 20...+ 40	- 20...+ 40	- 20...+ 40	- 20...+ 40	–
Temperature compensation	Open mounted	°C	- 20...+ 60	- 20...+ 60	- 20...+ 60	- 20...+ 60	- 25...+ 55 (3)
	In enclosure	°C	- 20...+ 40	- 20...+ 40	- 20...+ 40	- 20...+ 40	–
Flame resistance	Conforming to IEC 60695-2-1	°C	960	960	960	960	960
Maximum operating altitude		m	2000		3000	3000	2000
Suitable for isolation	Conforming to IEC 60947-1 § 7-1-6		Yes		Yes	–	Yes
Resistance to mechanical impact		J	0.5	0.5	0.5	0.5	0.5
			In enclosure: IK 06		IK 09	–	–
Sensitivity to phase failure			Yes, conforming to IEC 60947-4-1 § 7-2-1-5-2				

### Technical characteristics

Circuit-breaker type			GV2 ME	GV2 P	GV2 RT	GV3 P	GV3 ME80	GV7 R●20... R●100	GV7 R●150	GV7 R●220
Utilisation category	Conforming to IEC 60947-2		A			A	A	A		
	Conforming to IEC 60947-4-1		AC-3			AC-3	AC-3	AC-3		
Rated operational voltage (Ue)	Conforming to IEC 60947-2	V	690			690	690	690		
Rated insulation voltage (Ui)	Conforming to IEC 60947-2	V	690			690	690	750		
	Conforming to CSA C22-2 n° 14, UL 508	V	600			600	600 (B600)	600		
Rated operational frequency	Conforming to IEC 60947-2	Hz	50/60			50/60	50/60	50/60		
Rated impulse withstand voltage (U imp)	Conforming to IEC 60947-2	kV	6			6	6	8		
Total power dissipated per pole		W	2.5			8	8	5	8.7	14.5
Mechanical durability (C.O.: Close, Open)		C.O.	100 000			50 000	30 000	50 000	40 000	20 000
Electrical durability for AC-3 duty	440 V In/2	C.O.	100 000			–	30 000	50 000	40 000	20 000
	440 V In	C.O.	–			50 000	–	30 000	20 000	10 000
Duty class (maximum operating rate)		C.O./h	25			25	25	25		
Maximum conventional rated thermal current (Ith)	Conforming to IEC 60947-4-1	A	0.16... 32	0.16... 32	0.40... 23	13... 65	80	12... 100	150	220
Rated duty	Conforming to IEC 60947-4-1		Continuous duty							

(1) UL 508 type E for GV2 P●●H7

(2) Leave a space of 9 mm between 2 circuit-breakers: either an empty space, or side mounting add-on contact blocks. Horizontal mounting is possible up to 40 °C.

(3) For operation up to 70 °C, please consult your Regional Sales Office.

### Mounting characteristics

**Operating position**  
Without derating, in relation to normal vertical mounting plane

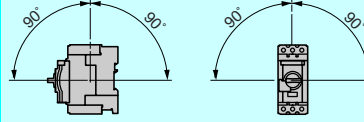

### Connection characteristics

#### Connection to screw clamp terminals or spring terminals

Bare cables

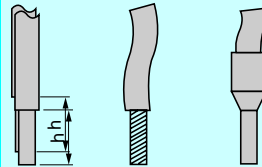

Circuit-breaker type		GV2 ME		GV2 P		GV3 P		GV3 ME80		
Connection to screw clamp terminals (1) (Max. number of conductors x c.s.a.)		Min.	Max.	Min.	Max.	Min.	Max.	Min.	Max.	
Solid cable	mm <sup>2</sup>	2 x 1	2 x 6	2 x 1	2 x 6	2 x 1	1 x 25 and 1 x 35	1 x 2.5	1 x 35	
	mm <sup>2</sup>	2 x 1.5	2 x 6	2 x 1.5	2 x 6	2 x 1	1 x 25 and 1 x 35	1 x 2.5	2 x 16	
	mm <sup>2</sup>	2 x 1	2 x 4	2 x 1	2 x 4	2 x 1	1 x 25 and 1 x 35	1 x 2.5	2 x 16	
<b>Tightening torque</b>		<b>N.m</b>	1.7	1.7	1.7	1.7	5	5: 25 mm <sup>2</sup> 8: 35 mm <sup>2</sup>	5	5
<b>Connection to spring terminals</b>										
<b>Number of conductors x c.s.a.</b>										
Solid cable	mm <sup>2</sup>	2 x 1 (2)	2 x 6	–	–	–	–	–	–	
	mm <sup>2</sup>	2 x 1.5 (2)	2 x 4	–	–	–	–	–	–	
Flexible cable without cable end										
Flexible cable with cable end										

#### Connection by bars or lugs

Bars or lugs

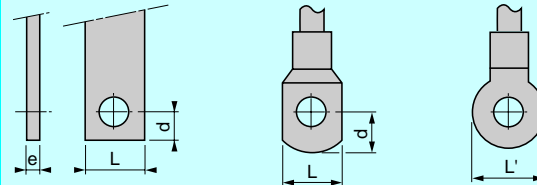

Circuit-breaker type		GV2 ME●●6	GV3 P●●6	GV7 R●20...R●100	GV7 R●150	GV7 R●220	
<b>Pitch</b>	Without spreaders	mm	13.5	17.5	35	35	
	With spreaders	mm	–	–	45	45	
<b>Bars or cables with lugs</b>	e	mm	≤ 6	≤ 6	≤ 6	≤ 6	
	L	mm	≤ 9.5	≤ 13.5	≤ 25	≤ 25	
	L'	mm	≤ 9.5	≤ 16.5	–	–	
	d	mm	≤ 10	≤ 10	≤ 10	≤ 10	
<b>Screws</b>			M4	M6	M6	M8	
	Tightening torque	<b>N.m</b>	1.7	6	10	15	15
<b>Bare cables (copper or aluminium) with connectors</b>	Height (h)	mm	–	–	20	20	
	C.s.a.	mm <sup>2</sup>	–	–	1.5...95	1.5...95	1.5...185
	Tightening torque	<b>N.m</b>	–	–	15	15	15

(1) For motor circuit-breakers **GV3 P**: BTR hexagon socket head screws, **EverLink®** system. Require use of an insulated Allen key, in compliance with local electrical wiring regulations.  
(2) For cross-sections 1 to 1.5 mm<sup>2</sup>, the use of an **LA9 D99** cable end reducer is recommended.

# TeSys protection components

## Thermal-magnetic motor circuit-breakers

### GV2 ME and GV2 P

#### Breaking capacity of GV2 ME and GV2 P

Circuit-breaker type				GV2 ME										GV2 P									
				01 to 06	07	08	10	14	16	20	21 & 22	23 & 25	32	01 to 06	07	08	10	14	16	20	21 & 22	23 & 25	32
<b>Rating</b>			<b>A</b>	0.1 to 1.6	2.5	4	6.3	10	14	18	23 & 25	32	0.1 to 1.6	2.5	4	6.3	10	14	18	23 & 25	32		
<b>Breaking capacity</b> conforming to IEC 60947-2	230/240 V	lcu	kA	★	★	★	★	★	★	★	★	50	50	★	★	★	★	★	★	★	★		
		lcs % (1)		★	★	★	★	★	★	★	★	100	100	★	★	★	★	★	★	★	★	★	
	400/415 V	lcu	kA	★	★	★	★	★	15	15	15	10	★	★	★	★	★	★	★	★	★		
		lcs % (1)		★	★	★	★	★	50	50	40	50	★	★	★	★	★	★	★	★	★	★	
	440 V	lcu	kA	★	★	★	50	15	8	8	6	6	★	★	★	★	★	★	★	★	★		
		lcs % (1)		★	★	★	100	100	50	50	50	50	★	★	★	★	★	★	★	★	★	★	
	500 V	lcu	kA	★	★	★	50	10	6	6	4	4	★	★	★	★	★	★	★	★	★		
		lcs % (1)		★	★	★	100	100	75	75	75	75	★	★	★	★	★	★	★	★	★	★	
	690 V	lcu	kA	★	3	3	3	3	3	3	3	3	★	8	8	6	6	6	4	4	4		
		lcs % (1)		★	75	75	75	75	75	75	75	75	★	100	100	100	100	100	100	100	100	100	
<b>Associated fuses (if required)</b> if lsc > breaking capacity lcu conforming to IEC 60947-2	230/240 V	aM	A	★	★	★	★	★	★	★	★	80	80	★	★	★	★	★	★	★	★		
		gG	A	★	★	★	★	★	★	★	★	100	100	★	★	★	★	★	★	★	★	★	
	400/415 V	aM	A	★	★	★	★	★	63	63	80	80	★	★	★	★	★	★	★	★	★		
		gG	A	★	★	★	★	★	80	80	100	100	★	★	★	★	★	★	★	★	★	★	
	440 V	aM	A	★	★	★	50	50	50	50	63	63	★	★	★	★	★	★	★	★	★		
		gG	A	★	★	★	63	63	63	63	80	80	★	★	★	★	★	★	★	★	★	★	
	500 V	aM	A	★	★	★	50	50	50	50	50	50	★	★	★	★	★	★	★	★	★		
		gG	A	★	★	★	63	63	63	63	63	63	★	★	★	★	★	★	★	★	★	★	
	690 V	aM	A	★	16	25	32	32	40	40	40	40	★	20	25	40	40	50	50	50	50		
		gG	A	★	20	32	40	40	50	50	50	50	★	25	32	50	50	63	63	63	63		

★ > 100 kA.  
(1) As % of lcu.

Breaking capacity of GV2 ME and GV2 P (used in association with current limiter GV1 L3)													
Circuit-breaker type			GV2 ME										
Rating			A	01 to 06	07	08	10	14	16	20	21	22	32
Breaking capacity conforming to IEC 60947-2			230/240 V	l <sub>cu</sub>	kA	★	★	★	★	★	★	★	★
				l <sub>cs</sub> % (1)		★	★	★	★	★	★	★	
			400/415 V	l <sub>cu</sub>	kA	★	★	★	★	★	100	100	
				l <sub>cs</sub> % (1)		★	★	★	★	★	50	50	
			440 V	l <sub>cu</sub>	kA	★	★	★	★	★	50	20	
				l <sub>cs</sub> % (1)		★	★	★	★	★	75	75	
			500 V	l <sub>cu</sub>	kA	★	★	★	★	★	50	42	
				l <sub>cs</sub> % (1)		★	★	★	★	★	100	100	
Circuit-breaker type			GV2 P										
Rating			A	01 to 06	07	08	10	14	16	20	21	22	32
Breaking capacity conforming to IEC 60947-2			230/240 V	l <sub>cu</sub>	kA	★	★	★	★	★	★	★	★
				l <sub>cs</sub> % (1)		★	★	★	★	★	★	★	
			400/415 V	l <sub>cu</sub>	kA	★	★	★	★	★	★	★	
				l <sub>cs</sub> % (1)		★	★	★	★	★	★	★	
			440 V	l <sub>cu</sub>	kA	★	★	★	★	★	100	100	
				l <sub>cs</sub> % (1)		★	★	★	★	★	50	50	
			500 V	l <sub>cu</sub>	kA	★	★	★	★	★	100	100	
				l <sub>cs</sub> % (1)		★	★	★	★	★	50	50	
			690 V (3)	l <sub>cu</sub> = l <sub>cs</sub>	kA	★	50	50	50	50	50	50	
Circuit-breaker type			GV2 ME										
Rating			A	01 to 06	07	08	10	14	16	20	21	22	32
Cable protection against thermal stress in the event of short-circuit (PVC insulated copper cables)			Minimum c.s.a. protected at 40 °C at l <sub>sc</sub> max.	1 mm <sup>2</sup>	●	●	●	≤ 10 kA	≤ 6 kA	(2)	(2)	(2)	(2)
				1.5 mm <sup>2</sup>	●	●	●	≤ 20 kA	≤ 10 kA	(2)	(2)	(2)	(2)
				2.5 mm <sup>2</sup>	●	●	●	●	●	●	●	●	(2)
				4...6 mm <sup>2</sup>	●	●	●	●	●	●	●	●	●

★ > 100 kA  
 ● Cable c.s.a. protected  
 (1) As % of l<sub>cu</sub>  
 (2) Cable c.s.a. not protected  
 (3) With limiter LA9 LB920

# TeSys protection components

## Thermal-magnetic motor circuit-breakers

### GV3 P and GV3 ME80

#### Breaking capacity of GV3 P and GV3 ME80

Motor circuit-breaker type			A	GV3 P						GV3 ME80		
				13	18	25	32	40	50		65	
Rating			A	13	18	25	32	40	50	65	80	
Breaking capacity conforming to IEC 60947-2	230/240 V	lcu	kA	100	100	100	100	100	100	100	100	
		lcs % (1)		100	100	100	100	100	100	100	100	
	400/415 V	lcu	kA	100	100	100	100	50	50	50	15	
		lcs % (1)		50	50	50	50	50	50	50	50	
	440 V	lcu	kA	50	50	50	50	50	50	50	10	
		lcs % (1)		50	50	50	50	50	50	50	60	
	500 V	lcu	kA	12	12	12	12	10	10	10	4	
		lcs % (1)		50	50	50	50	50	50	50	100	
	690 V	lcu	kA	6	6	6	6	5	5	5	2	
		lcs % (1)		50	50	50	50	60	60	60	100	
	Associated fuses, if required if I <sub>sc</sub> > breaking capacity I <sub>cu</sub>	230/240 V	aM	A	★	★	★	★	★	★	★	★
			gG	A	★	★	★	★	★	★	★	★
415 V		aM	A	★	★	★	★	125	125	125	315	
		gG	A	★	★	★	★	160	160	160	400	
440 V		aM	A	63	80	125	125	125	125	125	315	
		gG	A	80	100	160	160	160	160	160	400	
500 V		aM	A	63	63	63	63	80	80	80	200	
		gG	A	80	80	80	80	100	100	100	250	
690 V		aM	A	50	50	50	50	63	63	63	200	
		gG	A	63	63	63	63	80	80	80	250	

★ Fuse not required: breaking capacity I<sub>cn</sub> > I<sub>sc</sub>.  
 (1) As % of I<sub>cu</sub>.

Circuit-breaker type			GV7	GV7						
				RE20...RE100	RS20...RS100	RE150	RS150	RE220	RS220	
Rating			A	12...20 to 60...100		90...150	90...150	132...220	132...220	
Breaking capacity conforming to IEC 60947-2	230/240 V	l <sub>cu</sub>	kA	85	100	85	100	85	100	
		l <sub>cs</sub> % (1)		100	100	100	100	100	100	
	400/415 V	l <sub>cu</sub>	kA	36	70	35	70	35	70	
		l <sub>cs</sub> % (1)		100	100	100	100	100	100	
	440 V	l <sub>cu</sub>	kA	36	65	35	65	35	65	
		l <sub>cs</sub> % (1)		100	100	100	100	100	100	
	500 V	l <sub>cu</sub>	kA	18	50	30	50	30	50	
		l <sub>cs</sub> % (1)		100	100	100	100	100	100	
	690 V	l <sub>cu</sub>	kA	8	10	8	10	8	10	
		l <sub>cs</sub> % (1)		100	100	100	100	100	100	
	Cable protection against thermal stress in the event of short-circuit (PVC insulated copper cables)	Minimum c.s.a. protected at 40 °C at I <sub>sc</sub> max.	4 mm <sup>2</sup>		≤ 6 kA	≤ 6 kA	(2)	(2)	(2)	(2)
			6 mm <sup>2</sup>		●	≤ 25 kA	(2)	(2)	(2)	(2)
10...50 mm <sup>2</sup>				●	●	●	●	●	●	

(1) As % of I<sub>cu</sub>.  
 ● Cable c.s.a. protected.  
 (2) Cable c.s.a. not protected.

#### Environment

Circuit-breaker type		GV2 LE	GV2 L			
Conforming to standards		IEC 60947-1, 60947-2, EN 60204, NF C 63-650, NF C63-120, 79-130, VDE 0113, 0660, UL 1077.				
Product certifications		UL, CSA, CCC	UL, CSA, CCC, BV, DNV, GL, LROS, RINA			
Protective treatment		"TH"	"TH"			
Shock resistance	Conforming to IEC 60068-2-27	30 gn	30 gn			
Vibration resistance	Conforming to IEC 60068-2-6	5 gn (5 to 150 Hz)	5 gn (5 to 150 Hz)			
Ambient air temperature	Storage	°C - 40...+ 80	- 40...+ 80			
	Operation	°C - 20...+ 60	- 20...+ 60			
Flame resistance	Conforming to IEC 60695-2-1	°C 960	960			
Maximum operating altitude		m 2000	2000			
Operating position						
Connection (Max. number of conductors x c.s.a)	Solid cable	mm <sup>2</sup>	Min. 2 x 1	Max. 2 x 6	Min. 2 x 1	Max. 2 x 6
	Flexible cable without cable end	mm <sup>2</sup>	2 x 1.5	2 x 6	2 x 1.5	2 x 6
	Flexible cable with cable end	mm <sup>2</sup>	2 x 1	2 x 4	2 x 1	2 x 4
Tightening torque		N.m	1.7		1.7	
Suitable for isolation	Conforming to IEC 60947-1 § 7-1-6		Yes		Yes	
Resistance to mechanical impact		J	0.5		0.5	

#### Technical characteristics

Utilisation category	Conforming to IEC 60947-2		A	A
	Conforming to IEC 60947-4-1		AC-3	AC-3
Rated operational voltage (U <sub>e</sub> )	Conforming to IEC 60947-2	V	690	690
Rated insulation voltage (U <sub>i</sub> )	Conforming to IEC 60947-2	V	690	690
Rated operational frequency	Conforming to IEC 60947-2	Hz	50/60	50/60
Rated impulse withstand voltage (U <sub>imp</sub> )	Conforming to IEC 60947-2	kV	6	6
Total power dissipated per pole		W	1.8	1.8
Mechanical durability (C.O.: Closing, Opening)	For AC-3 duty	C.O.	100 000	100 000
Electrical durability for AC-3/415V duty (C.O.: Closing, Opening)		C.O.	100 000	100 000
Duty class (maximum operating rate)		C.O./h	40	40
Rated duty	Conforming to IEC 60947-4-1		Continuous duty	Continuous duty



Circuit-breaker type				GV2 LE										GV2 L																			
				03 to 06	07	08	10	14	16	20	22	32	03 to 06	07	08	10	14	16	20	22	32												
<b>Rating</b>			<b>A</b>	0.4 to 1.6	2.5	4	6.3	10	14	16	18	25	32	50	50	0.4 to 1	2.5	4	6.3	10	14	16	18	25	32								
<b>Breaking capacity</b> conforming to IEC 60947-2			230/240 V	lcu	<b>kA</b>	★	★	★	★	★	★	★	★	50	50	★	★	★	★	★	★	★	★	★	★	50	50						
						lcs % (1)		★	★	★	★	★	★	★	★	100	100	★	★	★	★	★	★	★	★	★	★	★	★	100	100		
			400/415 V	lcu	<b>kA</b>	★	★	★	★	★	15	15	15	10	★	★	★	★	★	★	★	★	★	★	★	50	50	50	50				
						lcs % (1)		★	★	★	★	★	★	★	★	50	50	40	50	★	★	★	★	★	★	★	★	★	★	50	50	50	50
			440 V	lcu	<b>kA</b>	★	★	★	50	15	8	8	6	6	★	★	★	★	★	★	★	★	★	★	★	20	20	20	20				
						lcs % (1)		★	★	★	100	100	50	50	50	50	50	50	★	★	★	★	★	★	★	★	★	★	★	75	75	75	75
			500 V	lcu	<b>kA</b>	★	★	★	50	10	6	6	4	4	★	★	★	★	★	★	★	★	★	★	★	10	10	10	10				
						lcs % (1)		★	★	★	100	100	75	75	75	75	75	75	★	★	★	★	★	★	★	★	★	★	★	100	75	75	75
			690 V	lcu	<b>kA</b>	★	3	3	3	3	3	3	3	3	★	4	4	4	4	4	4	4	4	4	4	4	4	4	4				
						lcs % (1)		★	75	75	75	75	75	75	75	75	75	75	★	100	100	100	100	100	100	100	100	100	100	100	100	100	100
<b>Associated fuses (if required)</b> if Isc > breaking capacity Icu conforming to IEC 60947-2 amendment 1			230/240 V	aM	<b>A</b>	★	★	★	★	★	★	★	★	80	80	★	★	★	★	★	★	★	★	★	★	★	★	100	100				
				gG	<b>A</b>	★	★	★	★	★	★	★	★	★	★	★	100	100	★	★	★	★	★	★	★	★	★	★	★	★	125	125	
			400/415 V	aM	<b>A</b>	★	★	★	★	★	★	★	★	63	63	80	80	★	★	★	★	★	★	★	★	★	★	80	100	100	100		
				gG	<b>A</b>	★	★	★	★	★	★	★	★	★	★	★	80	80	100	100	★	★	★	★	★	★	★	★	★	★	100	125	125
			440 V	aM	<b>A</b>	★	★	★	50	50	50	50	50	63	63	★	★	★	★	★	★	★	★	★	★	★	★	50	63	80	80	80	
				gG	<b>A</b>	★	★	★	63	63	63	63	63	63	63	63	80	80	★	★	★	★	★	★	★	★	★	★	★	★	63	80	100
			500 V	aM	<b>A</b>	★	★	★	50	50	50	50	50	50	50	★	★	★	★	★	★	★	★	★	★	★	★	50	50	50	50	50	
				gG	<b>A</b>	★	★	★	63	63	63	63	63	63	63	63	63	★	★	★	★	★	★	★	★	★	★	★	★	★	63	63	63
			690 V	aM	<b>A</b>	★	16	25	32	32	40	40	40	40	★	20	25	40	40	50	50	50	50	50	50	50	50	50	50	50	50	50	
				gG	<b>A</b>	★	20	32	40	40	50	50	50	50	50	50	★	25	32	50	50	63	63	63	63	63	63	63	63	63	63	63	63
<b>Cable protection against thermal stress in the event of short-circuit</b> (PVC insulated copper cables) Minimum c.s.a. protected at 40 °C and at Isc max.			1 mm <sup>2</sup>	<b>kA</b>	●	●	●	≤10	≤6	(2)	(2)	(2)	(2)	●	●	●	●	●	●	●	●	●	●	●	●	●	●	●	●	●	(2)		
			1.5 mm <sup>2</sup>	<b>kA</b>	●	●	●	≤20	≤10	(2)	(2)	(2)	(2)	(2)	●	●	●	●	●	●	●	●	●	●	●	●	●	●	●	●	●	●	(2)
			2.5 mm <sup>2</sup>		●	●	●	●	●	●	●	●	●	●	(2)	●	●	●	●	●	●	●	●	●	●	●	●	●	●	●	●	●	(2)
			4...6 mm <sup>2</sup>		●	●	●	●	●	●	●	●	●	●	●	●	●	●	●	●	●	●	●	●	●	●	●	●	●	●	●	●	●

★ > 100 kA  
 ● Cable c.s.a. protected  
 (1) As % of Icu  
 (2) Cable c.s.a. not protected

#### Environment

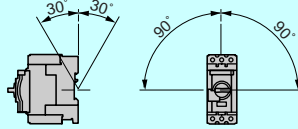
Circuit-breaker type		GV3 L	GK3 EF80			
Conforming to standards		IEC/EN 60947-1, 60947-2	IEC 60947-2, EN 60204			
Protective treatment		"TH"	"TC"			
Degree of protection	Conforming to IEC 60529	IP 20	IP 20			
Shock resistance	Conforming to IEC 60068-2-27	On : 15 gn -11 ms Off : 30 gn -11 ms	22 gn -20 ms			
Vibration resistance	Conforming to IEC 60068-2-6	5 gn (5...300 Hz)	2.5 gn (0...25 Hz)			
Flame resistance	Conforming to IEC 60695-2-1	°C 960	960			
Ambient air temperature	Storage	°C - 40...+ 80	- 40...+ 80			
	Operation	°C - 20...+ 60 (1)	- 20...+ 70 open mounted			
Maximum operating altitude		m 3000	3000			
Operating position				Any position		
Connection (Max. number of conductors x c.s.a)	Solid cable	mm <sup>2</sup>	Min. 2 x 1	Max. 1 x 25 1 x 35	Min. 1 x 2.5	Max. 1 x 35
	Flexible cable without cable end	mm <sup>2</sup>	2 x 1	1 x 25 1 x 35	1 x 2.5 or 2 x 2.5	1 x 25 or 2 x 16
	Flexible cable with cable end	mm <sup>2</sup>	2 x 1	1 x 25 1 x 35	1 x 2.5 or 2 x 2.5	1 x 25 or 2 x 16
Tightening torque		N.m	5	5 : 25 mm <sup>2</sup> 8 : 35 mm <sup>2</sup>	5	
Suitable for isolation conforming to IEC 60947-1 § 7-1-6			Yes		Yes	

#### Technical characteristics

Rated insulation voltage (U <sub>i</sub> )	Conforming to IEC 60947-2	V	690	750
Rated impulse withstand voltage (U <sub>imp</sub> )	Conforming to IEC 60947-2	kV	6	10
Rated operational voltage (U <sub>e</sub> )	Conforming to IEC 60947-2	V	690	690
Rated operational frequency		Hz	50/60	50...60
Electrical durability for AC-3/415V duty (C.O.: Close - Open)		C.O.	50 000	1500
Mechanical durability (C.O.: Closing, Opening)		C.O.	50 000	20 000
Maximum operating rate		C.O./h	25	40
Operating threshold of magnetic trips			14 I max	3363
Utilisation category	Conforming to IEC 60947-2		A	A

(1) Leave a space of 9 mm between 2 circuit-breakers: either an empty space or side-mounting add-on contact blocks. Horizontal mounting is possible up to 40 °C.

Breaking capacity of GV3 L and GK3 EF80									
Type			GV3 L25	GV3 L32	GV3 L40	GV3 L50	GV3 L65	GK3 EF80	
Breaking capacity of the circuit-breaker only or of the circuit-breaker combined with a thermal overload relay	230/240 V	Icu	kA	100	100	100	100	100	50
		Ics % (1)		100	100	100	100	100	40
	400/415 V	Icu	kA	100	100	50	50	50	35
		Ics % (1)		50	50	50	50	50	25
	440 V	Icu	kA	50	50	50	50	50	25
		Ics % (1)		50	50	50	50	50	30
500 V	Icu	kA	12	12	10	10	10	15	
	Ics % (1)		50	50	50	50	50	30	
690 V	Icu	kA	6	6	5	5	5	6	
	Ics % (1)		50	50	60	60	60	50	
Associated fuses (if required) for use with circuit-breaker only or circuit-breaker combined with a thermal overload relay if I <sub>sc</sub> > breaking capacity	230/240 V	aM	A	★	★	★	★	★	200
		gG	A	★	★	★	★	★	315
	415 V	aM	A	★	★	★	★	125	200
		gG	A	★	★	★	★	160	250
	440 V	aM	A	63	80	125	125	125	160
		gG	A	80	100	160	160	160	250
	500 V	aM	A	63	63	63	63	80	160
		gG	A	80	80	80	80	100	200
	690 V	aM	A	50	50	50	50	63	125
		gG	A	63	63	63	63	80	160
	Use of circuit-breakers without fuses			Minimum cable length (in metres) limiting the maximum short-circuit current to 35 kA maximum, so enabling breakers <b>GK3 EF80</b> to be used without fuses					
	Cable c.s.a.		mm <sup>2</sup>	≤ 25	35	50	70	95	120
I <sub>sc</sub> (rms) 3-phase, incoming (U <sub>e</sub> = 415 V)	50 kA	m	5	6	8	10	13	15	
	45 kA	m	5	5	7	8	10	12	
	40 kA	m	5	5	5	5	8	9	
	37 kA	m	5	5	5	5	5	5	

★ Fuse not required: breaking capacity I<sub>cn</sub> > I<sub>sc</sub>.

(1) As % of I<sub>cu</sub>

# TeSys protection components

## Thermal-magnetic motor circuit-breakers

### GV2, GV3 P and GV3 L

#### Auxiliary contacts

Type of contacts			Instantaneous auxiliary GV AN, GV AD							Fault signalling GV AD, GV AM11 (1)				Instantaneous auxiliary GV AE			
Rated insulation voltage (Ui) (associated insulation coordination)	Conforming to IEC 60947-1	V	690							690				250 (690 in relation to main circuit)			
	Conforming to CSA C22-2 n° 14 and UL 508	V	600							300				300			
Conventional thermal current (Ith)	Conforming to IEC 60947-5-1	A	6							2.5				2.5			
	Conforming to CSA C22-2 n° 14 and UL 508	A	5							1				1			
Mechanical durability (C.O.: Close - Open)		C.O.	100 000							1000				100 000			
Operational power and current conforming to IEC 60947-5-1. a.c. operation			AC-15/100 000 C.O.							AC-14/1000 C.O.				AC-15/100 000 C.O.			
	Rated operational voltage (Ue)	V	48	110	230	380	440	500	690	24	48	110	230	24	48	110	230
	Operational power, normal conditions	VA	300	500	720	850	650	500	400	36	48	72	72	48	60	120	120
	Occasional breaking and making capacities, abnormal conditions	kVA	3	7	13	15	13	12	9	0.22	0.3	0.45	0.45	0.48	0.6	1.27	2.4
	Rated operational current (Ie)	A	6	4.5	3.3	2.2	1.5	1	0.6	1.5	1	0.5	0.3	2	1.25	1	0.5
Operational power and current conforming to IEC 60947-5-1. d.c. operation			DC-13/100 000 C.O.							DC-13/1000 C.O.				DC-13/100 000 C.O.			
	Rated operational voltage (Ue)	V	24	48	60	110	240	—	—	24	48	60	—	24	48	60	—
	Operational power, normal conditions	W	140	240	180	140	120	—	—	24	15	9	—	24	15	9	—
	Occasional breaking and making capacities, abnormal conditions	W	240	360	240	210	180	—	—	100	50	50	—	100	50	50	—
	Rated operational current (Ie)	A	6	5	3	1.3	0.5	—	—	1	0.3	0.15	—	1	0.3	0.15	—
Low power switching reliability of contact			GV AE: Number of failures for "n" million operating cycles (17 V-5 mA): = 10 <sup>-6</sup>														
Minimum operational conditions d.c. operation		V	17														
		mA	5														
Short-circuit protection			By GB2 CB●● circuit-breaker (rating according to operational current for Ue ≤ 415 V) or by gG fuse 10 A max										GB2 CB06 or gG fuse 10 A max				
Cabling, screw clamp terminals		Number of conductors	1			2											
	Solid cable	mm <sup>2</sup>	1...2.5			1...2.5											
	Flexible cable without cable end	mm <sup>2</sup>	0.75...2.5			0.75...2.5											
	Flexible cable with cable end	mm <sup>2</sup>	0.75...1.5			0.75...1.5											
	Tightening torque	N.m	1.4 max			1.4 max											
Cabling, spring terminal connections		Flexible cable without cable end	mm <sup>2</sup> 0.75...2.5			0.75...2.5			—				0.75...1.5				

Operation of instantaneous auxiliary contacts

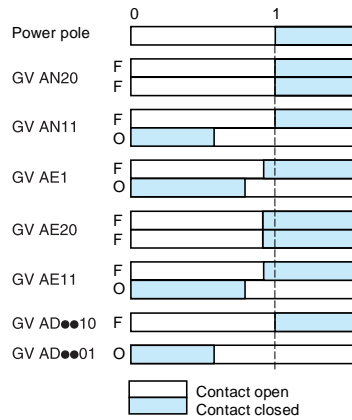

Operation of fault signalling contacts

**GV AM11**  
Change of state following tripping on  
short-circuit.

**GV AD10●● and GV AD01●●**  
Change of state following tripping on  
short-circuit, overload or undervoltage.

(1) For application example of fault signalling contact and short-circuit signalling contact, see page 24538/8.  
(2) Add an RC circuit type LA4 D to the load terminals, see page 24511/5.

# TeSys protection components

## Thermal-magnetic motor circuit-breakers

### GV3 ME80

#### Auxiliary contacts

Type of contacts			Instantaneous auxiliary contacts GV3 A01...A07						Fault signalling contacts GV3 A08 and A09							
Rated insulation voltage (Ui)	Conforming to IEC 60947-1	V	690						690							
	Conforming to CSA C22-2 n° 14, UL 508	V	600 (B600)						600 (B600)							
Conventional rated thermal current (Ith)	Conforming to IEC 60947-5-1	A	6						6							
	Conforming to CSA C22-2 n° 14, UL 508	A	5 (B600)						5 (B600)							
Mechanical durability (C.O.: Close - Open)		C.O.	100 000						1000							
Operational power and current conforming to IEC 60947-5-1 a.c. operation	Rated operational voltage (Ue)	V	48	110	220	380	440	500	690	48	110	220	380	440	500	690
	Operational power	VA	350	500	800	850	700	700	400	240	460	800	850	450	450	200
	Occasional breaking and making capacities	kVA	4	12	20	20	15	15	10	2.4	8	12	15	12	12	8
	Operational current (Ie)	A	6	4.5	3.5	2.2	1.5	1.5	0.6	5	3.6	3.5	2.2	1	1	0.3
	Rated operational voltage (Ue)	V	24	48	60	110	220	24	48	60	110	220				
Operational power and current conforming to IEC 60947-5-1 d.c. operation	Operational power	W	DC-11/100 000 C.O.						DC-11/1000 C.O.							
		W	180	240	180	140	120	120	120	90	70	60				
	Occasional breaking and making capacities	W	240	360	240	210	180	180	180	135	105	90				
	Operational current (Ie)	A	6	5	3	1.3	0.5	5	2.5	1.5	0.7	0.3				
	Short-circuit protection			By <b>GB2 CB08</b> circuit-breaker or gG fuse, 6A max												
Connection	Number of conductors		1			2										
	Solid cable	mm <sup>2</sup>	1...2.5			1...2.5										
	Flexible cable without cable end	mm <sup>2</sup>	0.75...2.5			0.75...2.5										
	Flexible cable with cable end	mm <sup>2</sup>	0.75...2.5			0.75...1.5										

**Contact operation**

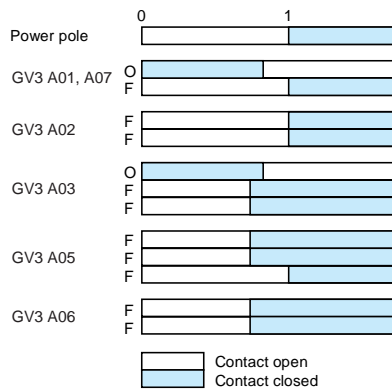

GV3 A08 and A09 change state following tripping on short-circuit or overload

# TeSys protection components

## Thermal-magnetic motor circuit-breakers

### GV7

#### Auxiliary contacts

#### Auxiliary contact characteristics

Type of contacts			GV7 AE11							GV7 AB11							
<b>Rated insulation voltage</b> (Ui) (associated insulation coordination)	Conforming to IEC 60947-1	<b>V</b>	690							690							
<b>Conventional thermal current</b> (Ith)	Conforming to IEC 60947-5-1	<b>A</b>	6							6							
<b>Mechanical durability</b> (C.O.: Close - Open)		<b>C.O.</b>	50 000							50 000							
<b>Operational current</b> conforming to IEC 60947-5-1 a.c. operation	Rated operational voltage (Ue)	<b>V</b>	AC-12 or AC-15. 50 000 C.O.														
			<b>24</b>	<b>48</b>	<b>110</b>	<b>230/240</b>	<b>380/415</b>	<b>440</b>	<b>690</b>	<b>24</b>	<b>48</b>	<b>110</b>	<b>230/240</b>	<b>380/415</b>	<b>440</b>	<b>690</b>	
	Rated operational current (Ie)	AC-12	<b>A</b>	6	6	6	6	6	6	6	5	5	5	5	5	5	5
		AC-15	<b>A</b>	6	6	5	4	3	3	0.1	5	5	4	3	2.5	2.5	0.1
<b>Operational current</b> conforming to IEC 60947-5-1 d.c. operation	Rated operational voltage (Ue)	<b>V</b>	DC-12 or DC-14. 50 000 C.O.														
			<b>24</b>	<b>48</b>	<b>110</b>	<b>250</b>	<b>24</b>	<b>48</b>	<b>110</b>	<b>250</b>							
	Rated operational current (Ie)	DC-12	<b>A</b>	2.5	2.5	0.8	0.3	2	2	0.5	–						
		DC-14	<b>A</b>	1	0.2	0.5	0.03	0.5	0.1	0.25	–						
<b>Minimum operational conditions</b> d.c. operation		<b>V</b>	17							12							
		<b>mA</b>	5							5							
<b>Short-circuit protection</b>			By <b>GB2 CB●●</b> circuit-breaker (rating according to operational current for Ue ≤ 415 V) or gG fuse, 10 A max.														
<b>Cabling</b>	Solid cable	<b>mm<sup>2</sup></b>	1 x 1.5 conductor							1 x 1.5 conductor							
	Flexible cable without cable end	<b>mm<sup>2</sup></b>	1 x 1.5 conductor							1 x 1.5 conductor							
	Flexible cable with cable end	<b>mm<sup>2</sup></b>	1 x 1.5 conductor							1 x 1.5 conductor							

#### Characteristics of Start-Stop and fault signalling contacts

<b>Rated insulation voltage (Ui)</b>	Conforming to IEC 60947-1	<b>V</b>	500					
<b>Rated operational voltage (Ue)</b>	Conforming to IEC 60947-1	<b>V</b>	500					
<b>Conventional thermal current (Ith)</b>	Conforming to IEC 60947-5-1	<b>A</b>	6					
<b>Operational power and current</b> conforming to IEC 60947-5-1 a.c. operation (C.O.: Close - Open)	Rated operational voltage (Ue)	<b>V</b>	AC-15. 20 000 C.O.					
	Operational power	<b>VA</b>	48	110/127	220/240	380/415	440	500
	Occasional breaking and making capacities	<b>VA</b>	4000	12 000	20 000	20 000	15 000	15 000
	Rated operational current (Ie)	<b>A</b>	6	4.5	3.5	2.2	1.5	1.5
<b>Operational power and current</b> conforming to IEC 60947-5-1 d.c. operation (C.O.: Close - Open)	Rated operational voltage (Ue)	<b>V</b>	DC-13. 1000 C.O.					
	Operational power	<b>W</b>	24	48	60	110	220	
	Occasional breaking and making capacities	<b>W</b>	240	280	240	210	180	
	Rated operational current (Ie)	<b>A</b>	6	5	3	1.3	0.5	
<b>Short-circuit protection</b>	Conforming to IEC 60947-5-1		By <b>GB2 CB08</b> circuit-breaker or gG fuse, 6A max					
<b>Cabling</b>	Solid cable	<b>mm<sup>2</sup></b>	1 x 1...4 conductor					
	Flexible cable without cable end	<b>mm<sup>2</sup></b>	1 x 2.5 conductor					
	Flexible cable with cable end	<b>mm<sup>2</sup></b>	1 x 1...2.5 conductor or 2 x 1...2.5 conductors					
<b>Tightening torque</b>		<b>N.m</b>	0.8					

**Characteristics of electric trips**

Circuit-breaker type			GV2 ME, GV2 P GV3 P, GV3 L		GV2 ME only	GV3 ME80		GV7 R	
Type of trip			GV AU	GV AS	GV AX (1)	GV3 B	GV3 D	GV7 AU	GV7 AS
Rated insulation voltage (Ui)	Conforming to IEC 60947-1	V	690	690	500	690	690	690	690
	Conforming to CSA C22-2 n° 14, UL 508	V	600	600	–	600 (B600)	600 (B600)	600	600
Operational voltage	Conforming to IEC 60947-1	V	0.85...1.1 Un	0.7...1.1 Un	0.85...1.1 Un	0.8...1.1 Un		0.85...1.1 Un	0.7...1.1 Un
Drop-out voltage		V	0.7...0.35 Un	0.75...0.2 Un	0.7...0.35 Un	0.7...0.35 Un		0.35...0.7 Ue	0.2...0.75 Ue
Inrush consumption	~	VA	12	14	12	12		< 10	
	≡	W	8	10.5	8	7		< 5	
Sealed consumption	~	VA	3.5	5	3.5	7		< 5	
	≡	W	1.1	1.6	1.1	2.5		< 5	
Operating time	Conforming to IEC 60947-1	ms	From the moment the voltage reaches its operational value until opening of the circuit-breaker. 10...15			10	15	< 50	
On-load factor			100 %			100 %		100 %	
Cabling	Number of conductors		2 or 4			1 or 2		1	
	Solid cable	mm <sup>2</sup>	1...2.5			1...2.5		1.5	
	Flexible cable without cable end	mm <sup>2</sup>	0.75...2.5			0.75...2.5		1.5	
	Flexible cable with cable end	mm <sup>2</sup>	0.75...1.5			0.75...2.5		1	
Tightening torque		N.m	1.4 max			1.2		1.2	
Mechanical durability (C.O.: Close - Open)		C.O.	30 000 (GV2 ME and GV2 P) 10 000 (GV3 P and GV3 L)			50 % of the mechanical durability of the circuit-breaker			

(1) Wiring scheme of undervoltage trip for dangerous machines (conforming to INRS) on GV2 ME only, see page 24538/8.



## Characteristics of 3-pole busbars GV2 G●●● and GV3 G364

			GV2 G●●●	GV3 G364
Rated insulation voltage (Ui)	Conforming to IEC 60947-1	V	690	690
Conventional thermal current (Ith)	Conforming to IEC 60439-1	A	63	115
Permissible peak current (I peak)		kA	11	20
Permissible thermal limit (I <sup>2</sup> t)		kA <sup>2</sup> s	104	300
Degree of protection	Conforming to IEC 60529		IP 20	IP 20
Terminal block			Yes	–

## Characteristics of terminal blocks GV2 G05 and GV1 G09 (for GV2 ME and GV2 P)

Rated insulation voltage (Ui)	Conforming to IEC 60947-1	V	690
Conventional thermal current (Ith)	Conforming to IEC 60439-1	A	63
Degree of protection	Conforming to IEC 60529		IP 20
Connection	Solid cable	mm <sup>2</sup>	1 x 1.5 to 25 conductor or 2 x 1.5 to 10 conductors
	Flexible cable without cable end	mm <sup>2</sup>	1 x 1.5 to 25 conductor or 2 x 2.5 to 10 conductors
	Flexible cable with cable end	mm <sup>2</sup>	1 x 1.5 to 16 conductor or 2 x 1.5 to 4 conductors
Tightening torque	Connector	N.m	2.2
	Screw clamp terminals	N.m	1.7

## Characteristics of current limiters (GV2 ME and GV2 P)

Type			GV1 L3	LA9 LB920		
Rated insulation voltage (Ui)	Conforming to IEC 60947-1	V	690	690		
Conventional thermal current (Ith)	Conforming to IEC 60947-1	A	63	63		
Operating threshold	rms current	A	1500 (non adjustable threshold)	1000 (non adjustable threshold)		
Connection			<b>1 conductor</b>	<b>2 conductors</b>	<b>1 conductor</b>	<b>2 conductors</b>
	Solid cable	mm <sup>2</sup>	1.5...25	1.5...10	1.5...25	1.5...10
	Flexible cable without cable end	mm <sup>2</sup>	1.5...25	2.5...10	1.5...25	1.5...10
	Flexible cable with cable end	mm <sup>2</sup>	1.5...16	1.5... 4	1.5...16	1.5... 4
Tightening torque		N.m	2.2			

#### Thermal-magnetic tripping curves for GV2 ME and GV2 P

Average operating times at 20 °C related to multiples of the setting current

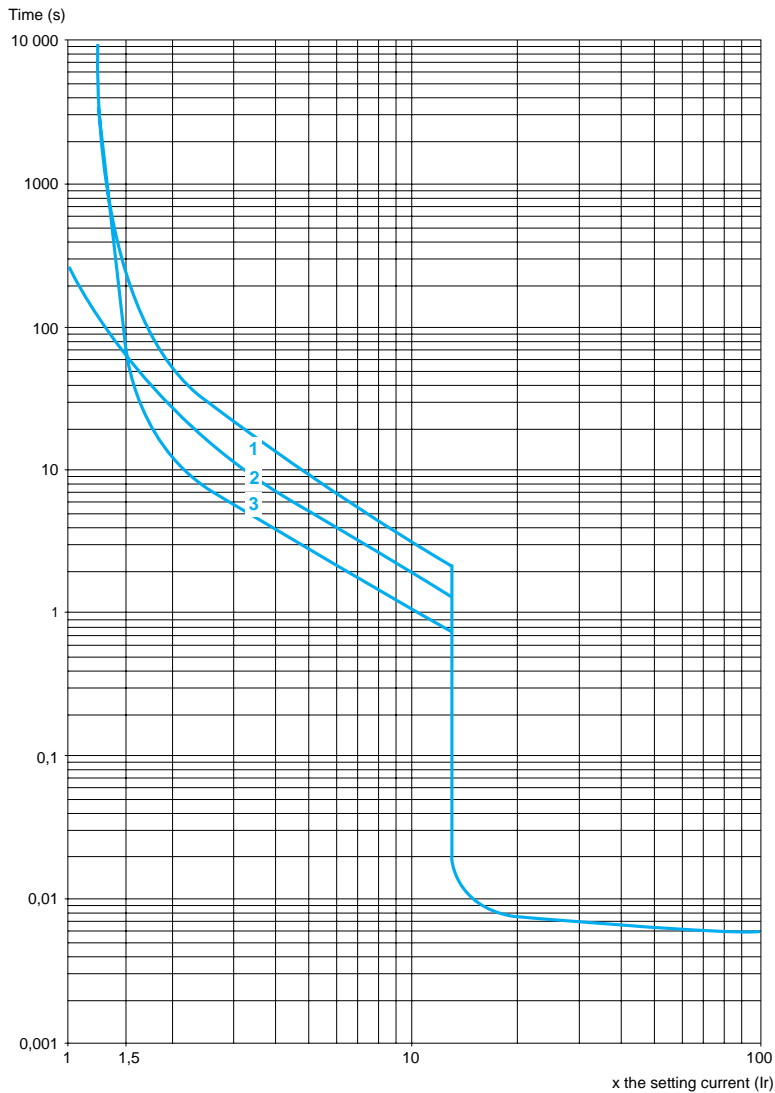

- 1 3 poles from cold state
- 2 2 poles from cold state
- 3 3 poles from hot state

**Current limitation on short-circuit for GV2 ME and GV2 P (3-phase 400/415 V)**  
Dynamic stress

$I_{peak} = f(\text{prospective } I_{sc}) \text{ at } 1.05 U_e = 435 \text{ V}$

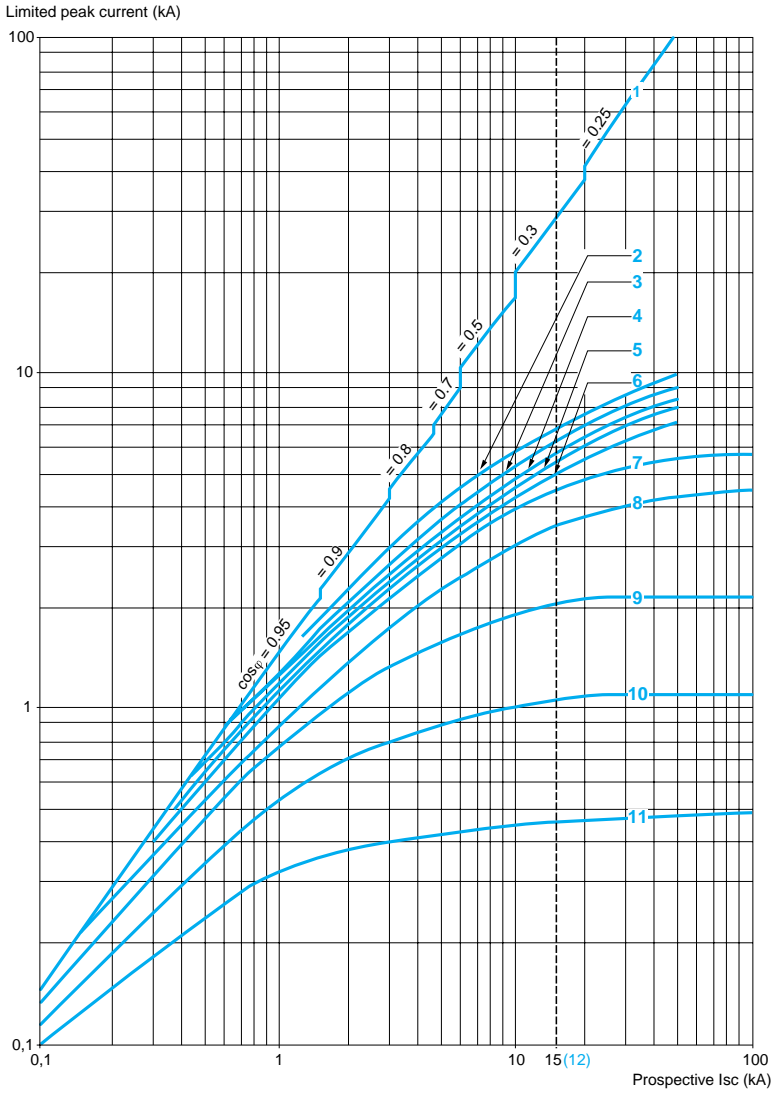

- 1 Maximum peak current
- 2 24 -32 A
- 3 20 -25 A
- 4 17 -23 A
- 5 13 -18 A
- 6 9 -14 A
- 7 6 -10 A
- 8 4 -6.3 A
- 9 2.5 -4 A
- 10 1.6 -2.5 A
- 11 1 -1.6 A
- 12 Limit of rated ultimate breaking capacity on short-circuit of GV2 ME (14, 18, 23 and 25 A ratings)

**Thermal limit on short-circuit for GV2 ME**  
**Thermal limit in kA<sup>2</sup>s in the magnetic operating zone**

Sum of  $I^2dt = f$  (prospective  $I_{sc}$ ) at  $1.05 U_e = 435 V$

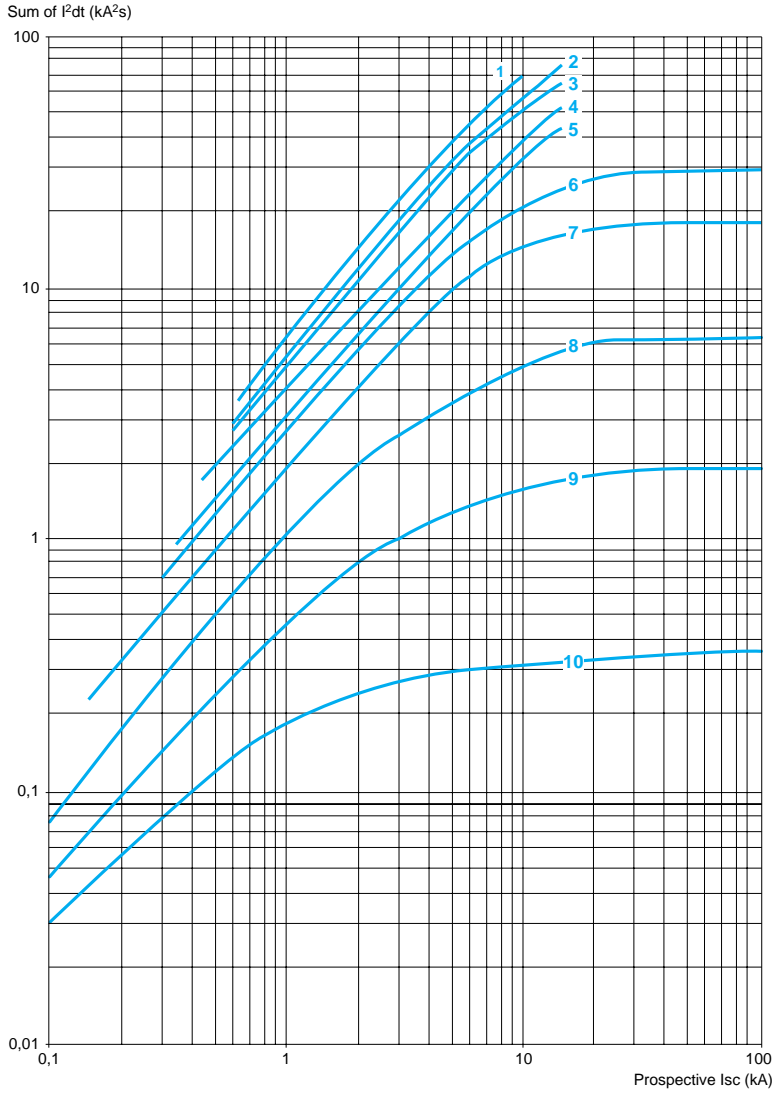

- 1 24 -32 A
- 2 20 -25 A
- 3 17 -23 A
- 4 13 -18 A
- 5 9 -14 A
- 6 6 -10 A
- 7 4 -6.3 A
- 8 2.5 -4 A
- 9 1.6 -2.5 A
- 10 1 -1.6 A

#### Thermal limit on short-circuit for GV2 P

Thermal limit in kA<sup>2</sup>s in the magnetic operating zone

Sum of I<sup>2</sup>dt = f (prospective I<sub>sc</sub>) at 1.05 U<sub>e</sub> = 435 V

Sum of I<sup>2</sup>dt (kA<sup>2</sup>s)

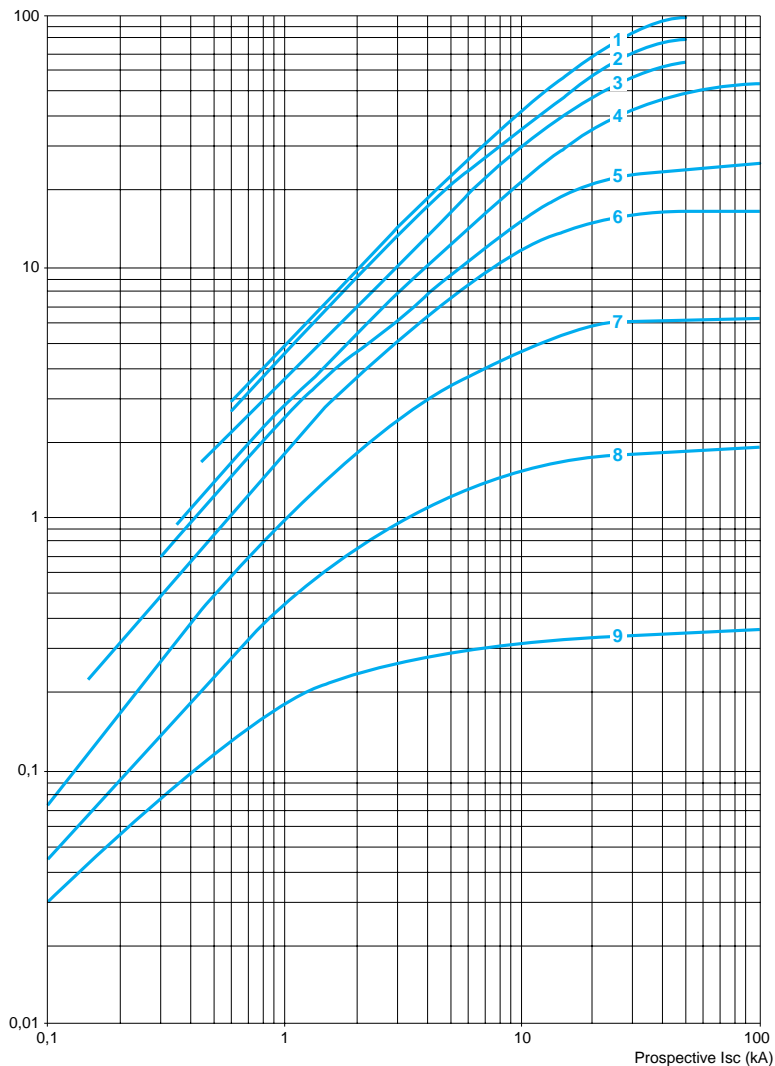

- 1 24 -32 A
- 1 20 -25 A
- 2 17 -23 A
- 3 13 -18 A
- 4 9 -14 A
- 5 6 -10 A
- 6 4 -6.3 A
- 7 2.5 -4 A
- 8 1.6 -2.5 A
- 9 1 -1.6 A

## Thermal-magnetic tripping curves

Average operating times at 20 °C related to multiples of the setting current

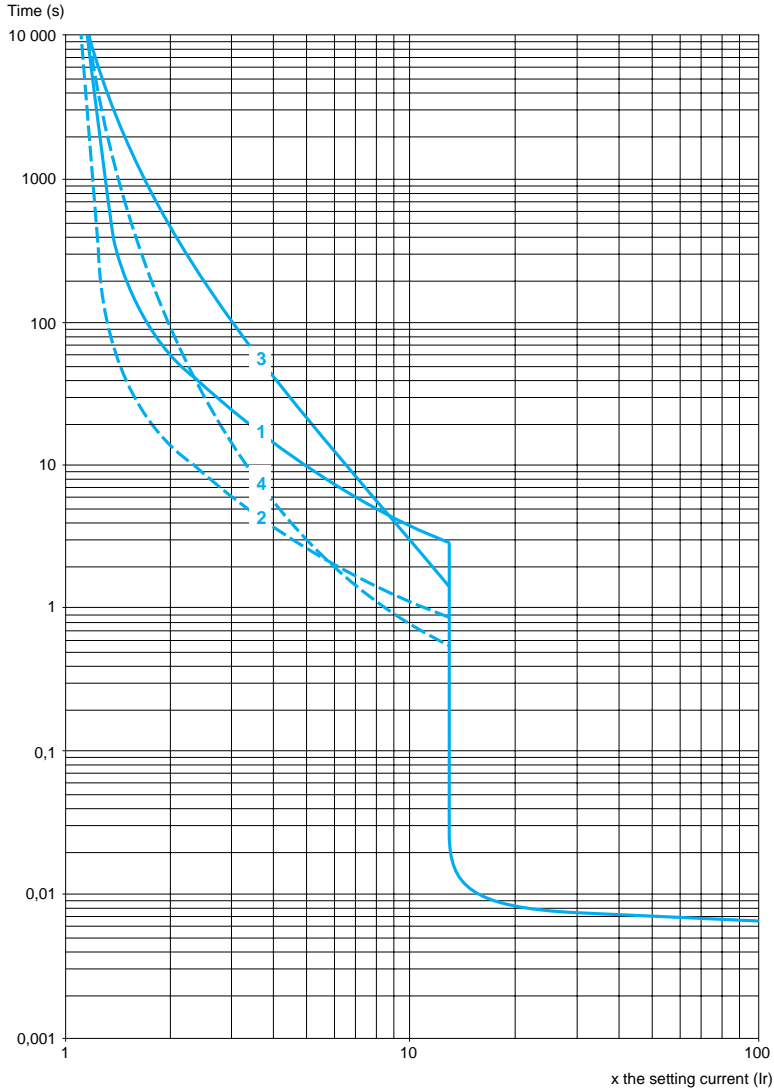

- 1 3 poles from cold state (GV3 P)
- 2 3 poles from hot state (GV3 P)
- 3 3 poles from cold state (GV3 ME80)
- 4 3 poles from hot state (GV3 ME80)

#### Current limitation on short-circuit (3-phase 400/415 V)

##### Dynamic stress

$I_{peak} = f(\text{prospective } I_{sc})$  at  $1.05 U_e = 435 \text{ V}$

Limited peak current (kA)

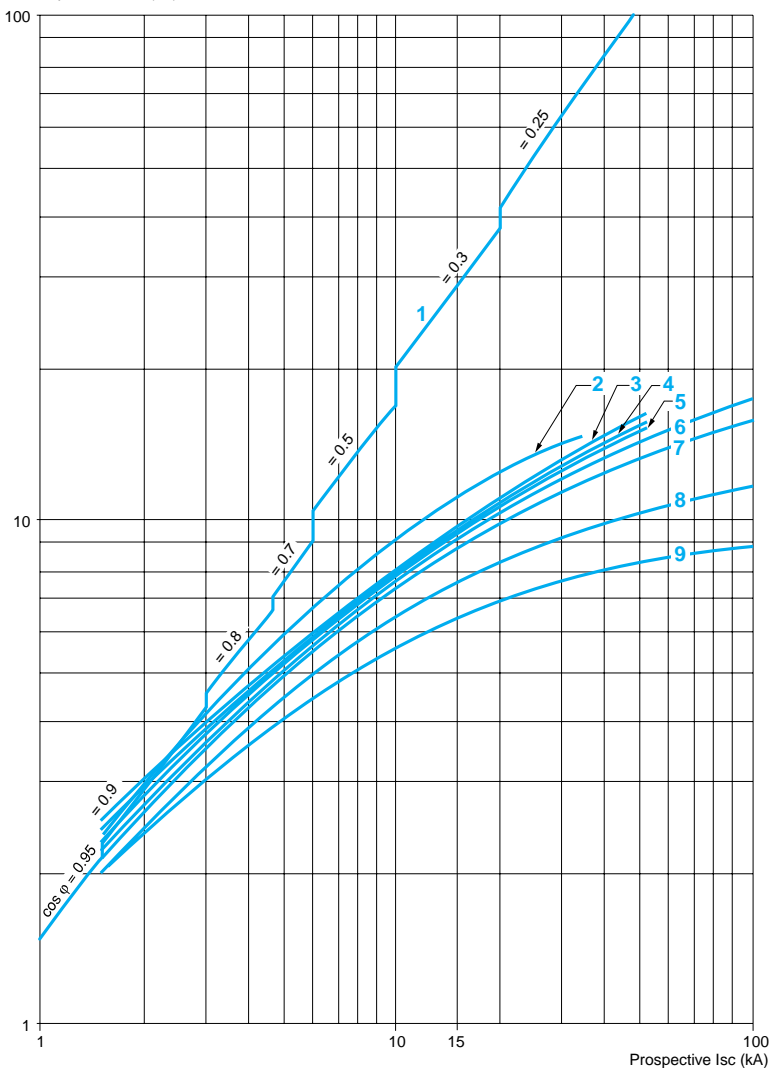

- 1 Maximum peak current
- 2 56 -80 A
- 3 48 -65 A
- 4 37 -50 A
- 5 30 -40 A
- 6 23 -32 A
- 7 17 -25 A
- 8 12 -18 A
- 9 9 -13 A

#### Maximum thermal limit on short-circuit

Thermal limit in  $\text{kA}^2\text{s}$  in the magnetic operating zone

Sum of  $I^2dt = f$  (prospective  $I_{sc}$ ) at  $1.05 U_e = 435 \text{ V}$

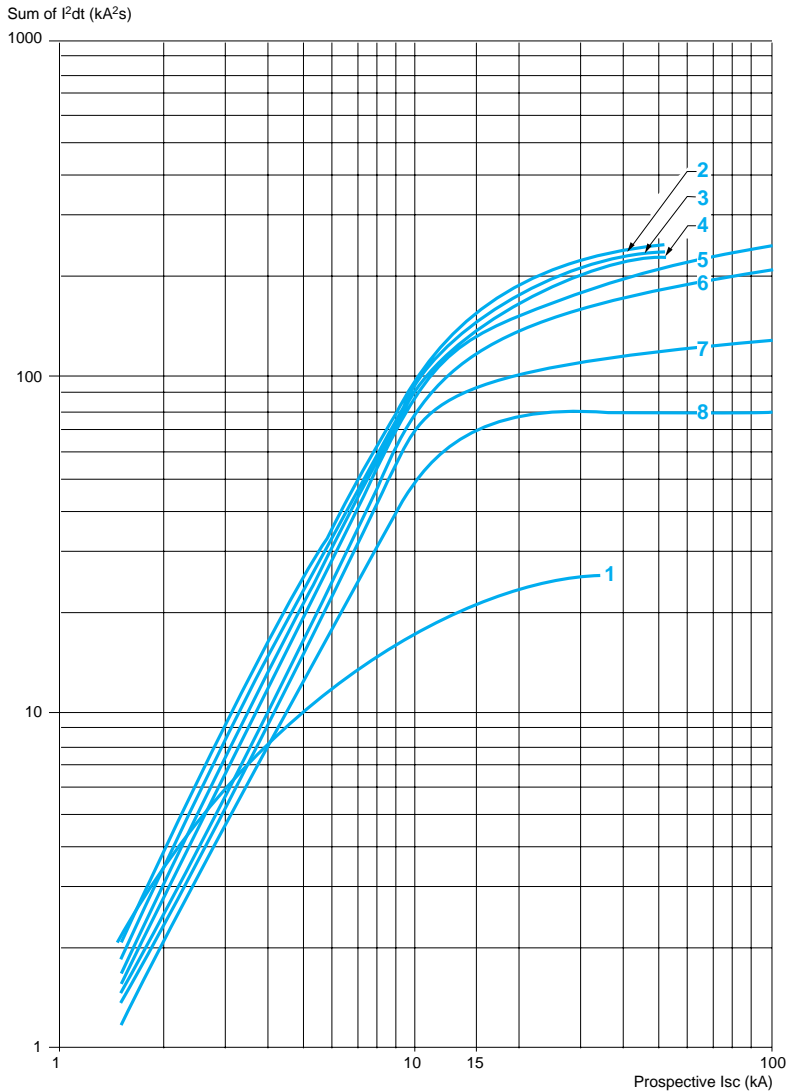

- 1 56-80 A (GV3 ME80)
- 2 48-65 A (GV3 P65)
- 3 37-50 A (GV3 P50)
- 4 30-40 A (GV3 P40)
- 5 23-32 A (GV3 P32)
- 6 17-25 A (GV3 P25)
- 7 12-18 A (GV3 P18)
- 8 9-13 A (GV3 P13)



#### Thermal-magnetic tripping curves for GV7 R

Average operating times at 20 °C related to multiples of the setting current

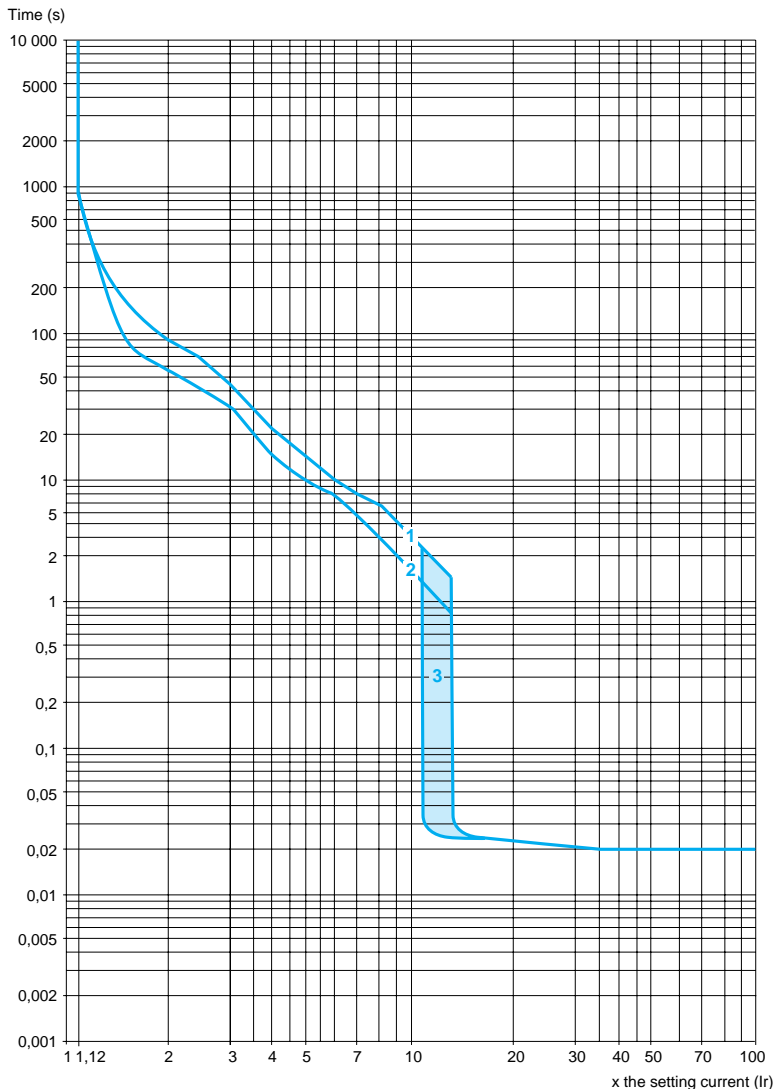

1 Cold state curve

2 Cold state curve

3 12...14 Ir

In the event of total phase failure, tripping occurs after  $4\text{ s} \pm 20\%$

**Current limitation on short-circuit (3-phase 400/415 V)**

**Dynamic stress**

$I_{peak} = f(\text{prospective } I_{sc})$

**For GV7 RE only**

Limited peak current (kA)

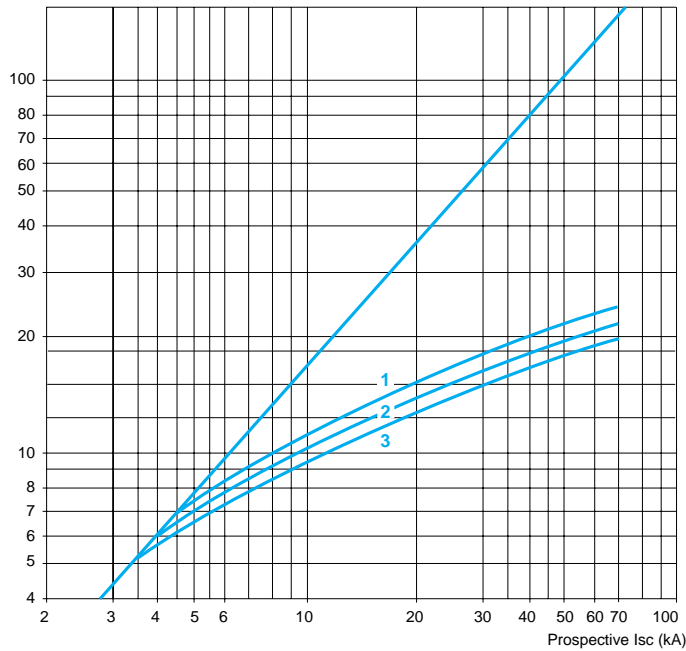

- 1 GV7 RE220
- 2 GV7 RE150
- 3 GV7 RE100

**For GV7 RS only**

Limited peak current (kA)

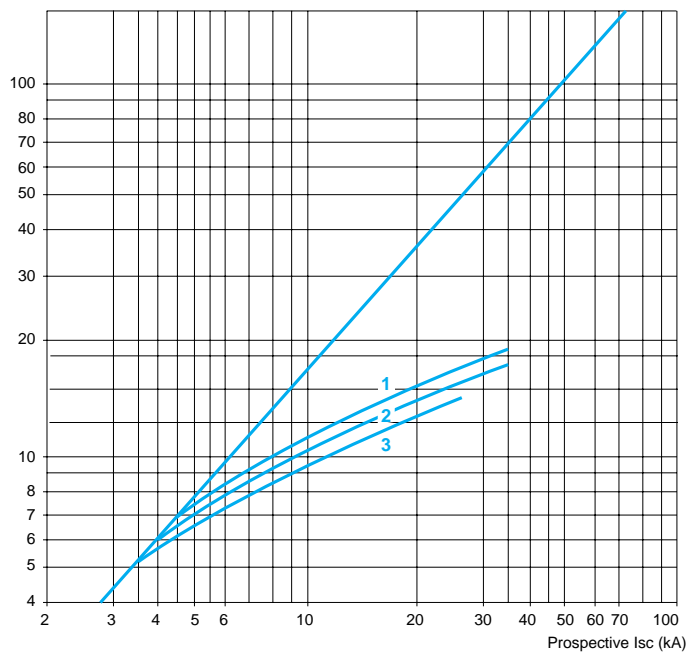

- 1 GV7 RS220
- 2 GV7 RS150
- 3 GV7 RS100

#### Thermal limit (3-phase 400/415 V)

#### Thermal limit

Sum of  $I^2dt = f$  (prospective  $I_{sc}$ )

#### For GV7 RE only

Sum of  $I^2dt$  (A<sup>2</sup>s)

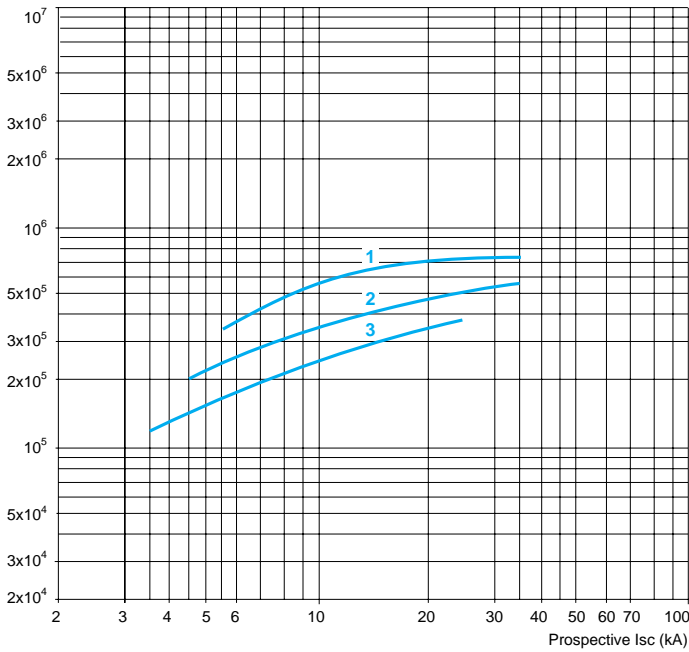

- 1 GV7 RE220
- 2 GV7 RE150
- 3 GV7 RE100

#### For GV7 RS only

Sum of  $I^2dt$  (A<sup>2</sup>s)

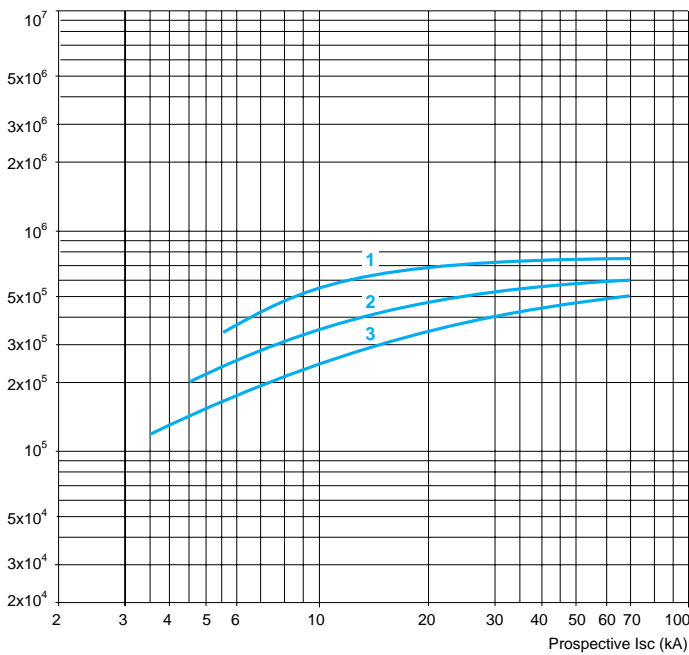

- 1 GV7 RS220
- 2 GV7 RS150
- 3 GV7 RS100

**Current limitation on short-circuit (3-phase 690 V)**

**Dynamic stress**

$I_{peak} = f(\text{prospective } I_{sc})$

**For GV7 RE only**

Limited peak current (kA)

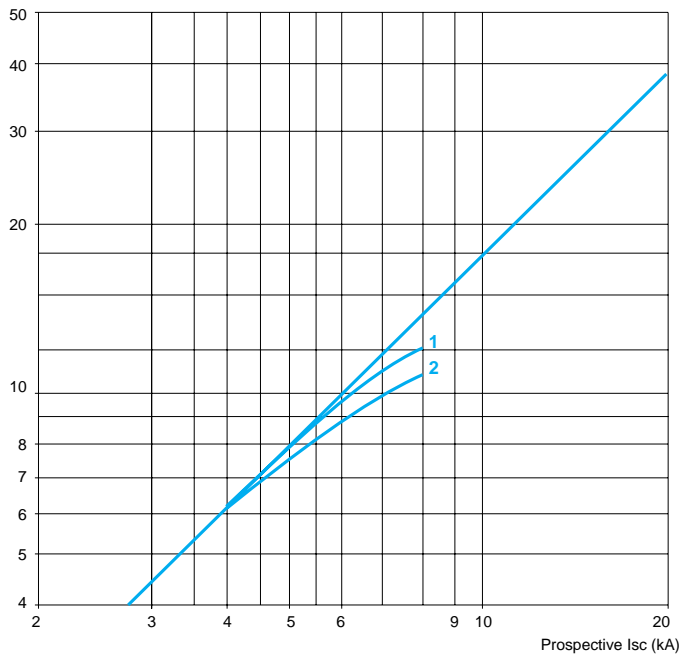

- 1 GV7 RE220
- 2 GV7 RE150 and GV7 RE100

**For GV7 RS only**

Limited peak current (kA)

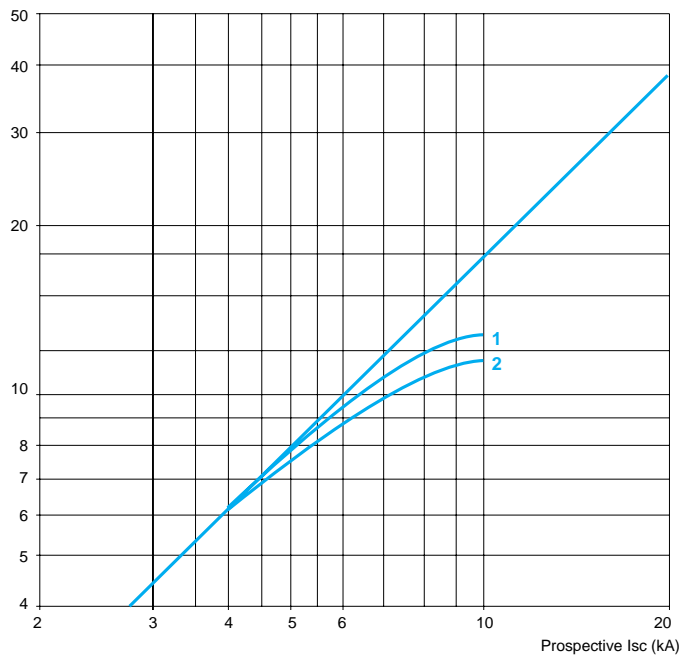

- 1 GV7 RS220
- 2 GV7 RS150 and GV7 RS100

**Thermal limit on short-circuit (3-phase 690 V)**

**Thermal limit**

Sum of  $I^2dt = f$  (prospective  $I_{sc}$ )

**For GV7 RE only**

Sum of  $I^2dt$  (A<sup>2</sup>s)

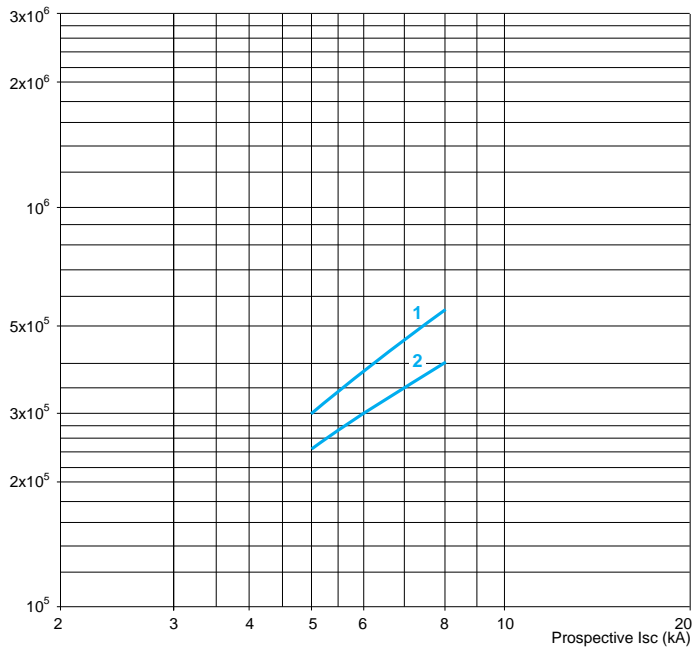

- 1 GV7 RE220
- 2 GV7 RE150 and GV7 RE100

**For GV7 RS only**

Sum of  $I^2dt$  (A<sup>2</sup>s)

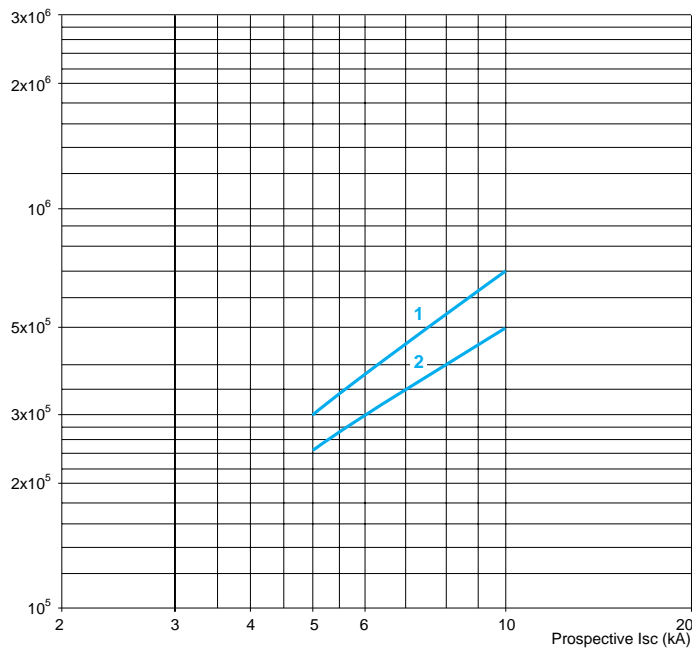

- 1 GV7 RS220
- 2 GV7 RS150 and GV7 RS100

## Thermal-magnetic tripping curves for GV2 RT

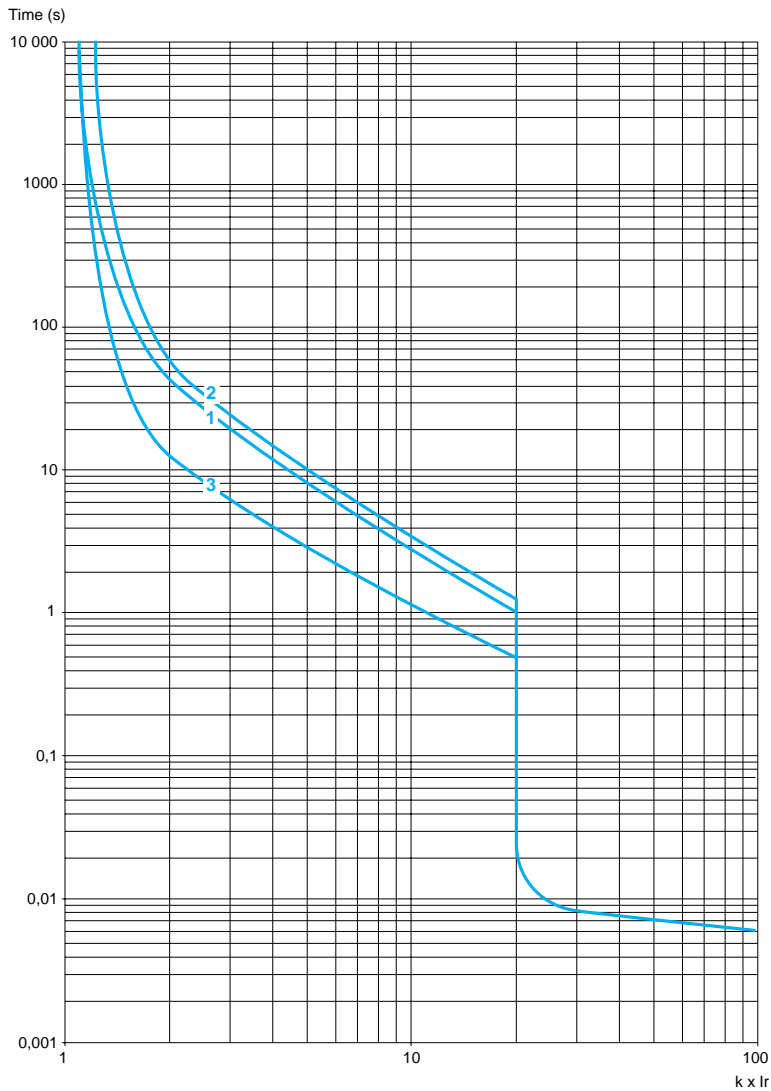

- 1 3 poles from cold state
- 2 2 poles from cold state
- 3 3 poles from hot state

**Tripping curves for GV2 L or LE combined with thermal overload relay LRD or LR2 K**  
Average operating times at 20 °C related to multiples of the setting current

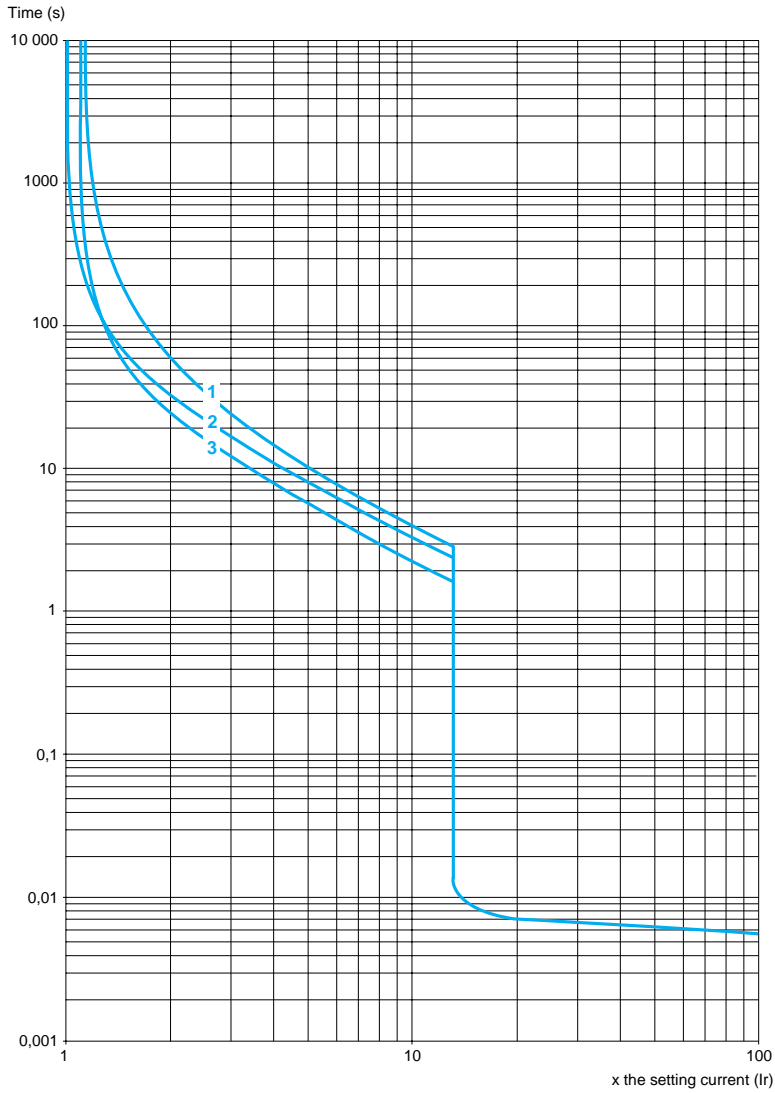

- 1 3 poles from cold state
- 2 2 poles from cold state
- 3 3 poles from hot state

**Current limitation on short-circuit for GV2 L and GV2 LE only (3-phase 400/415 V)**  
**Dynamic stress**

$I_{peak} = f(\text{prospective } I_{sc}) \text{ at } 1.05 U_e = 435 \text{ V}$

Limited peak current (kA)

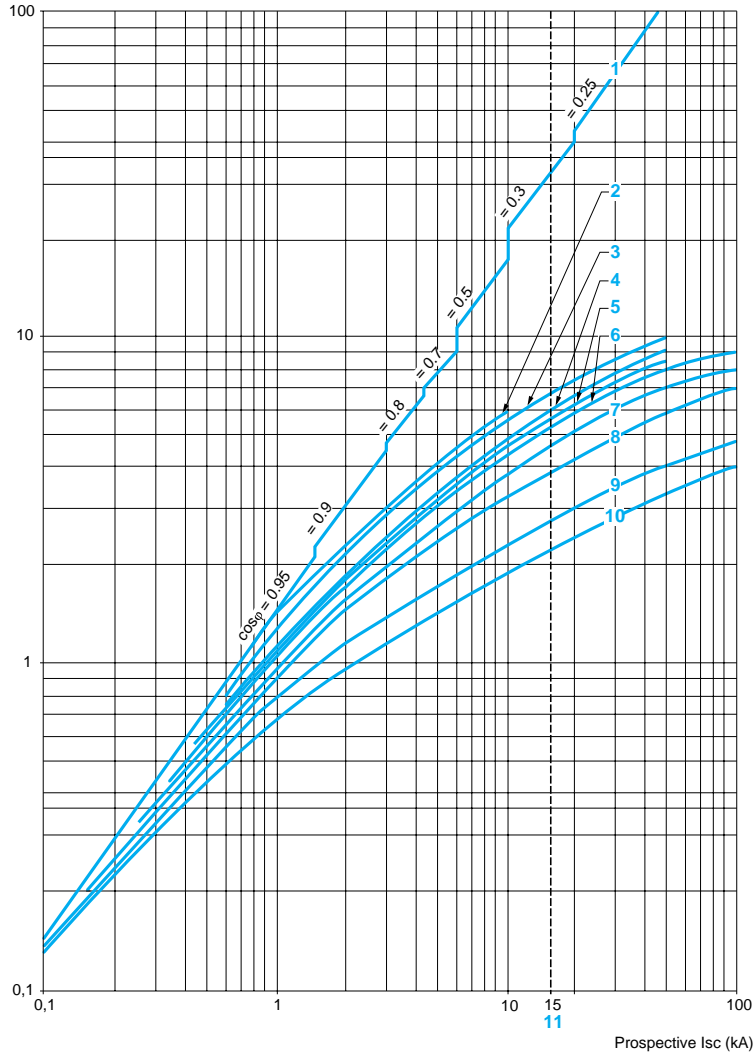

- 1 Maximum peak current
- 2 32 A
- 3 25 A
- 4 18 A
- 5 14 A
- 6 10 A
- 7 6.3 A
- 8 4 A
- 9 2.5 A
- 10 1.6 A
- 11 Limit of rated ultimate breaking capacity on short-circuit of GV2 LE (14, 18, 23 and 25 A ratings).



**Current limitation on short-circuit for GV2 L and GV2 LE + thermal overload relay LRD or LR2 K (3-phase 400/415 V)**  
Dynamic stress

$I_{peak} = f(\text{prospective } I_{sc}) \text{ at } 1.05 U_e = 435 \text{ V}$

Limited peak current (kA)

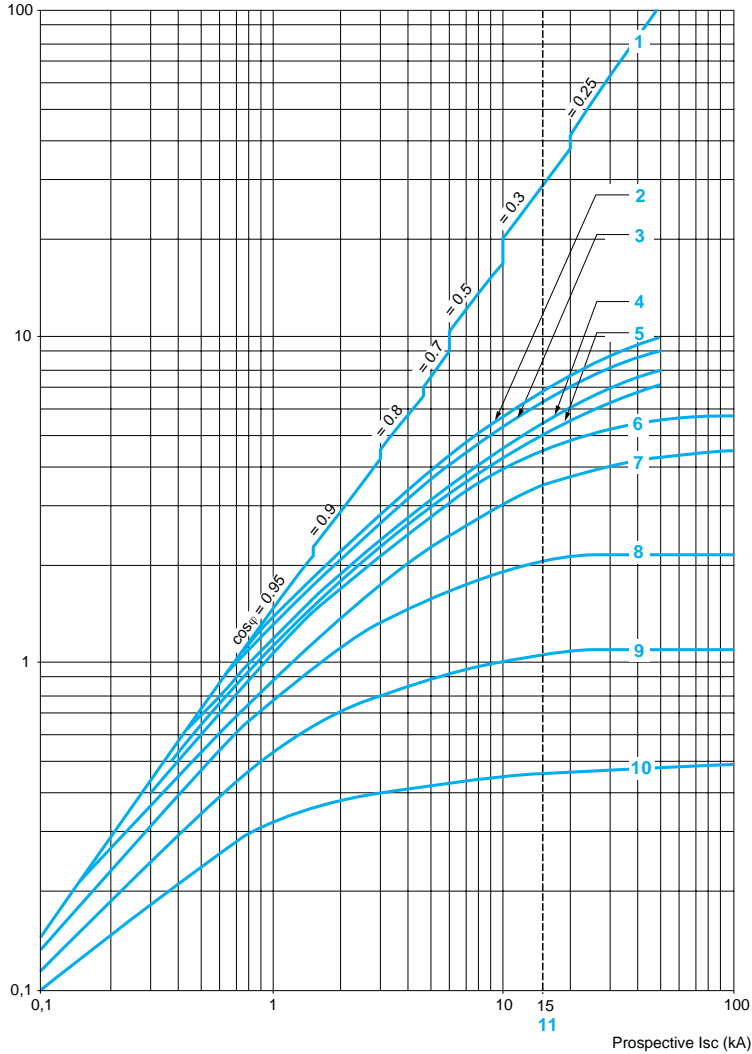

- 1 Maximum peak current
- 2 32 A
- 3 25 A
- 4 18 A
- 5 14 A
- 6 10 A
- 7 6.3 A
- 8 4 A
- 9 2.5 A
- 10 1.6 A
- 11 Limit of rated ultimate breaking capacity on short-circuit of GV2 LE (14, 18, 23 and 25 A ratings).

#### Thermal limit on short-circuit for GV2 LE only

Thermal limit in kA<sup>2</sup>s in the magnetic operating zone

Sum of I<sup>2</sup>dt = f (prospective I<sub>sc</sub>) at 1.05 U<sub>e</sub> = 435 V

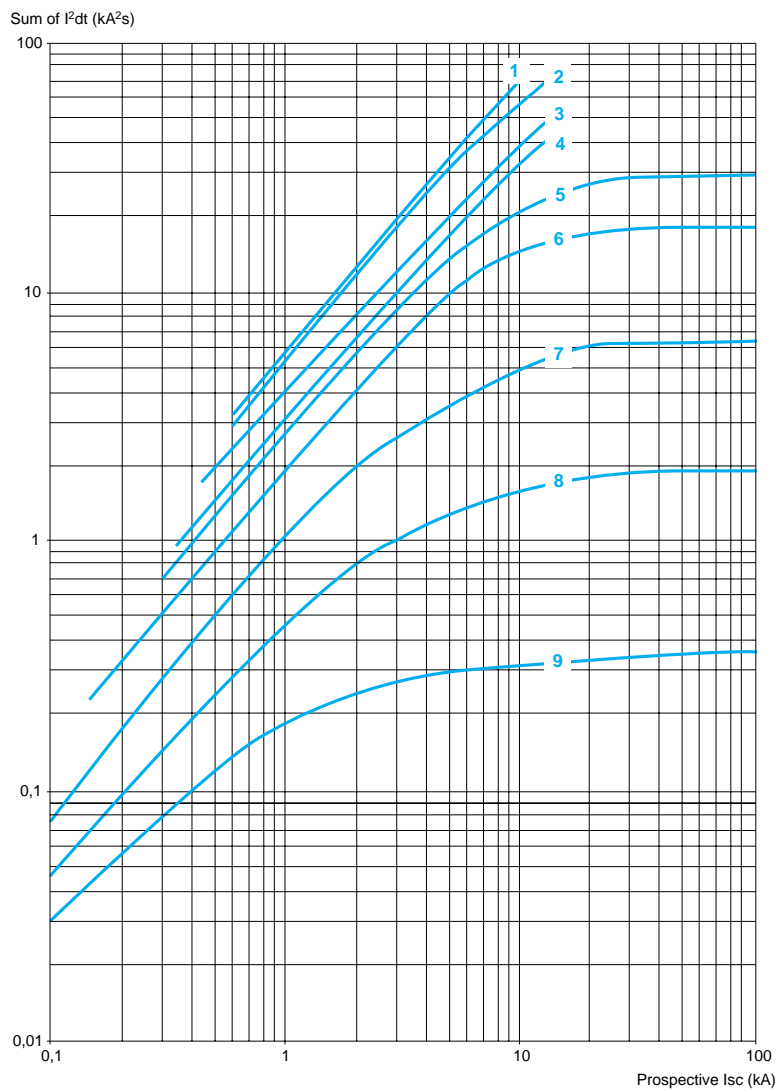

- 1 32 A
- 2 25 A
- 3 18 A
- 4 14 A
- 5 10 A
- 6 6.3 A
- 7 4 A
- 8 2.5 A
- 9 1.6 A

#### Thermal limit on short-circuit for GV2 L only

Thermal limit in kA<sup>2</sup>s in the magnetic operating zone

Sum of  $I^2dt = f$  (prospective  $I_{sc}$ ) at 1.05  $U_e = 435$  V

Sum of  $I^2dt$  (kA<sup>2</sup>s)

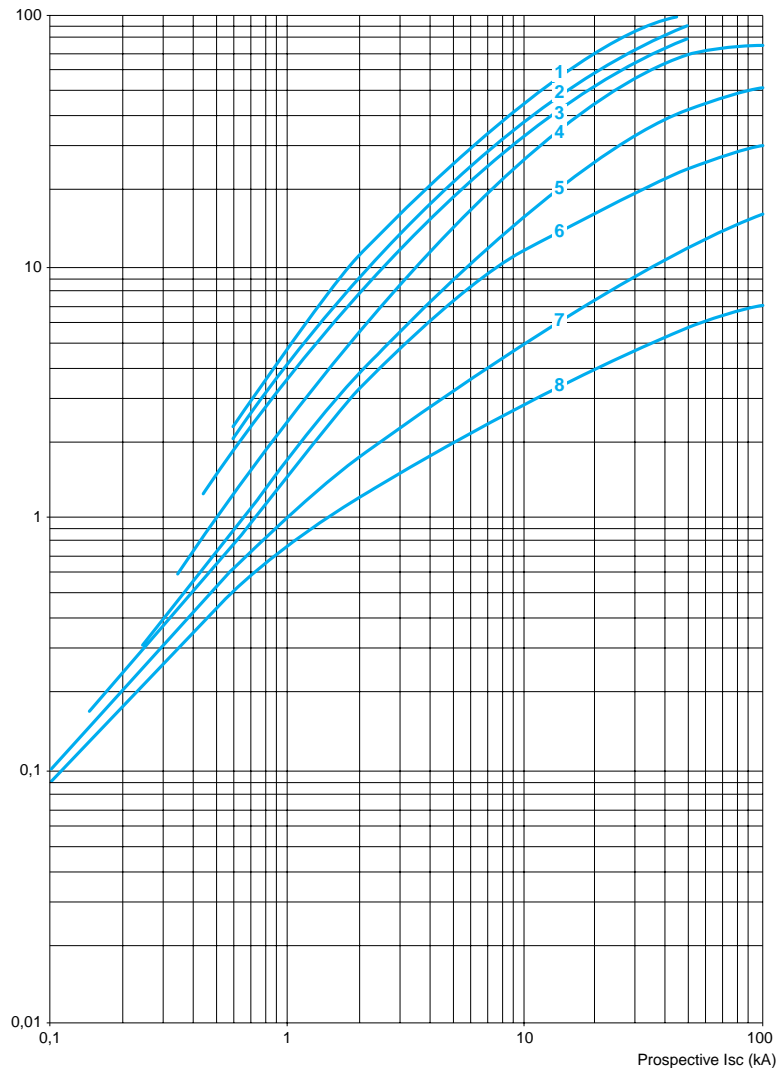

- 1 25 A and 32 A
- 2 18 A
- 3 14 A
- 4 10 A
- 5 6.3 A
- 6 4 A
- 7 2.5 A
- 8 1.6 A

**Thermal limit on short-circuit for GV2 L and GV2 LE + thermal overload relay LRD or LR2 K**  
Thermal limit in kA<sup>2</sup>s in the magnetic operating zone

Sum of I<sup>2</sup>dt = f (prospective I<sub>sc</sub>) at 1.05 U<sub>e</sub> = 435 V

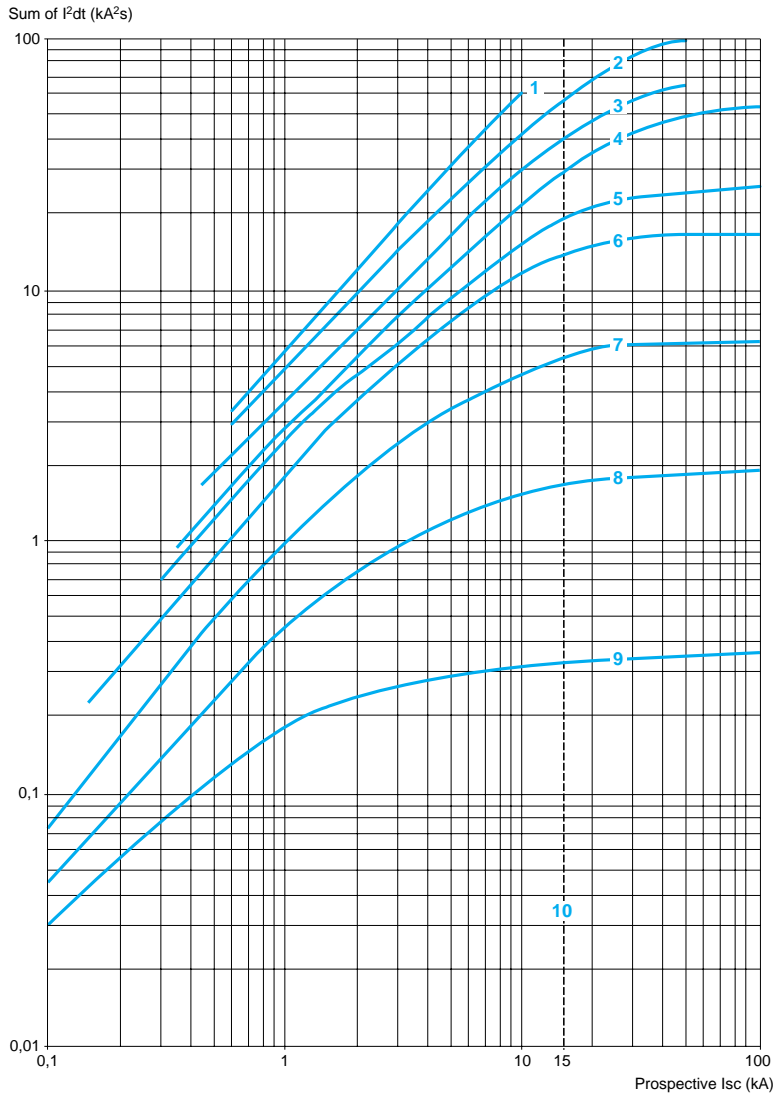

- 1 32 A (GV2 LE32)
- 2 25 A and 32 A (GV2 L32)
- 3 18 A
- 4 14 A
- 5 10 A
- 6 6.3 A
- 7 4 A
- 8 2.5 A
- 9 1.6 A
- 10 Limit of rated ultimate breaking capacity on short-circuit of GV2 LE (14, 18, 23 and 25 A ratings).

**Tripping curves for GV3 L and GK3 EF80 combined with thermal overload relay LRD 33**

Average operating time at 20 °C without prior current flow

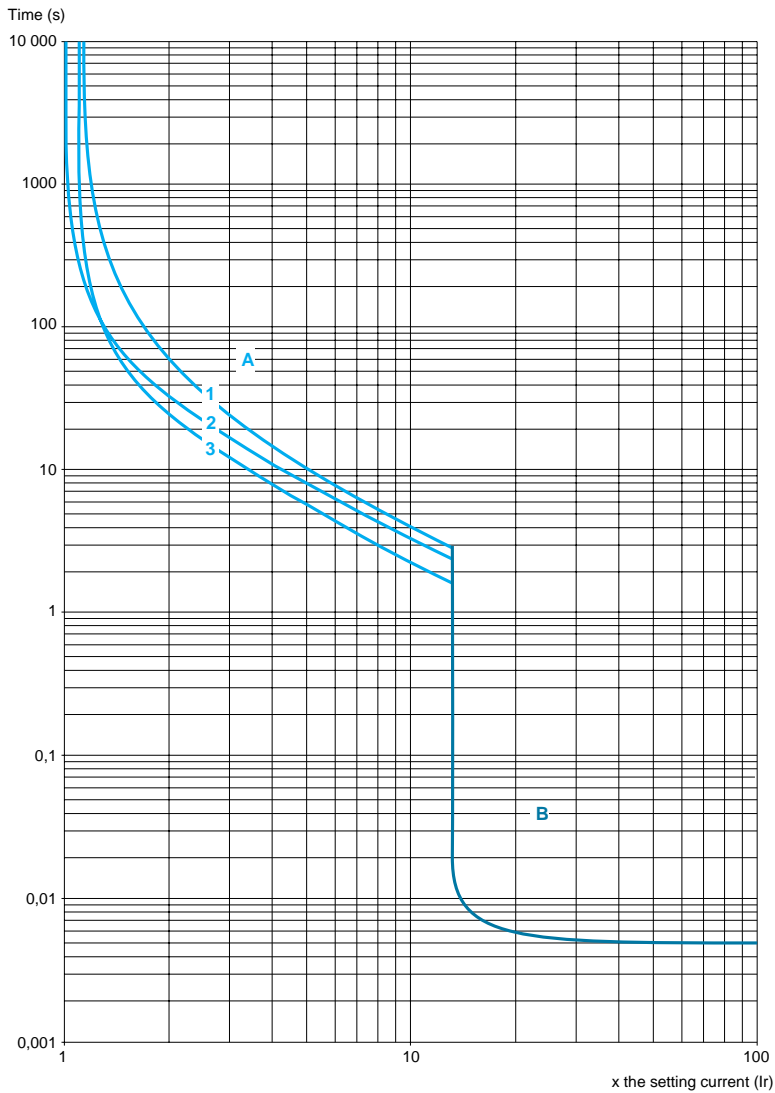

- 1 3 poles from cold state
- 2 2 poles from cold state
- 3 3 poles from hot state

- A Thermal overload relay protection zone
- B GK3 EF80 and GV3 protection zone L

**Current limitation on short-circuit for GV3 L and GK3 EF80 (3-phase 400/415 V)**

**Dynamic stress**

$I_{peak} = f(\text{prospective } I_{sc}) \text{ at } 1.05 U_e = 435 \text{ V}$

Limited peak current (kA)

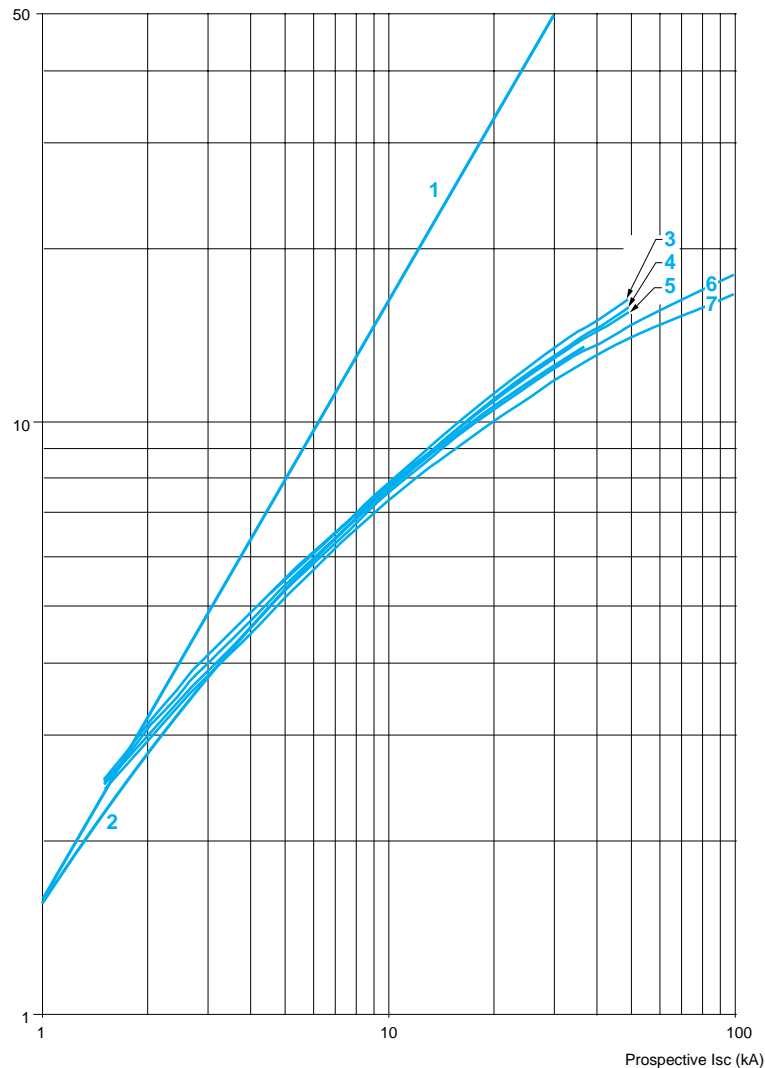

- 1 Maximum peak current
- 2 GK3 EF80
- 3 GV3 L65
- 4 GV3 L50
- 5 GV3 L40
- 6 GV3 L32
- 7 GV3 L25

#### Thermal limit on short-circuit for GV3 L and GK3 EF80

Thermal limit in A<sup>2</sup>s

Sum of I<sup>2</sup>dt = f (prospective I<sub>sc</sub>) at 1.05 U<sub>e</sub> = 435 V

Sum of I<sup>2</sup>dt (A<sup>2</sup>s)

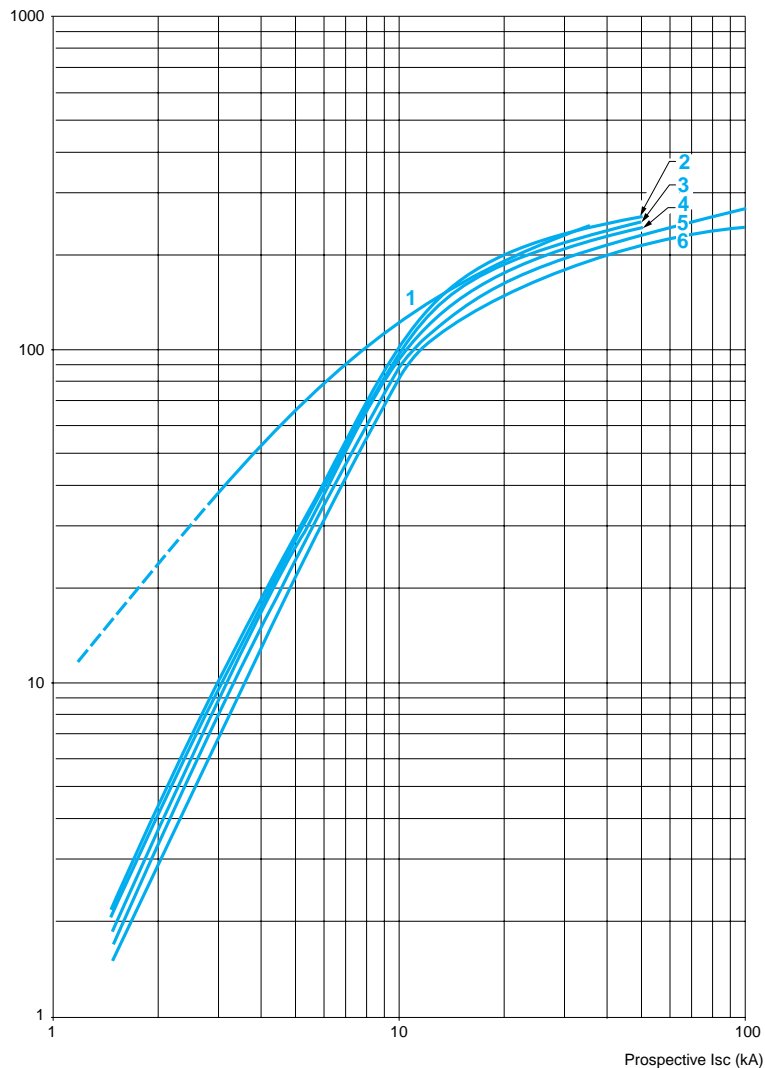

- 1 GK3 EF80
- 2 GV3 L65
- 3 GV3 L50
- 4 GV3 L40
- 5 GV3 L32
- 6 GV3 L25

# TeSys protection components

## Thermal-magnetic motor circuit-breakers

### GV2 ME

533086



GV2 ME10

#### Motor circuit-breakers from 0.06 to 15 kW / 400 V, with screw clamp terminals

##### GV2 ME with pushbutton control

Standard power ratings of 3-phase motors  
50-60 Hz in category AC-3

400/415 V			500 V			690 V			Setting range of thermal trips (2)	Magnetic tripping current Id ± 20 %	Reference	Weight
P	Icu	Ics (1)	P	Icu	Ics (1)	P	Icu	Ics (1)				
kW	kA	%	kW	kA	%	kW	kA	%	A	A	kg	
-	-	-	-	-	-	-	-	-	0.1...0.16	1.5	GV2 ME01	0.260
0.06	★	★	-	-	-	-	-	-	0.16...0.25	2.4	GV2 ME02	0.260
0.09	★	★	-	-	-	-	-	-	0.25...0.40	5	GV2 ME03	0.260
0.12	★	★	-	-	-	0.37	★	★	0.40...0.63	8	GV2 ME04	0.260
0.18	★	★	-	-	-	-	-	-	-	-	-	-
0.25	★	★	-	-	-	0.55	★	★	0.63...1	13	GV2 ME05	0.260
0.37	★	★	0.37	★	★	-	-	-	1...16	22.5	GV2 ME06	0.260
0.55	★	★	0.55	★	★	0.75	★	★	-	-	-	-
-	-	-	0.75	★	★	1.1	★	★	-	-	-	-
0.75	★	★	1.1	★	★	1.5	3	75	1.6...2.5	33.5	GV2 ME07	0.260
1.1	★	★	1.5	★	★	2.2	3	75	2.5...4	51	GV2 ME08	0.260
1.5	★	★	2.2	★	★	3	3	75	-	-	-	-
2.2	★	★	3	50	100	4	3	75	4...6.3	78	GV2 ME10	0.260
3	★	★	4	10	100	5.5	3	75	6...10	138	GV2 ME14	0.260
4	★	★	5.5	10	100	7.5	3	75	-	-	-	-
5.5	15	50	7.5	6	75	9	3	75	9...14	170	GV2 ME16	0.260
-	-	-	-	-	-	11	3	75	-	-	-	-
7.5	15	50	9	6	75	15	3	75	13...18	223	GV2 ME20	0.260
9	15	40	11	4	75	18.5	3	75	17...23	327	GV2 ME21	0.260
11	15	40	15	4	75	-	-	-	20...25	327	GV2 ME22 (3)	0.260
15	10	50	18.5	4	75	22	3	75	24...32	416	GV2 ME32	0.260

#### Motor circuit-breakers from 0.06 to 15 kW / 400 V, with lugs

To order thermal magnetic circuit-breakers with connection by lugs, add the digit 6 to the end of reference selected above.

Example: GV2 ME08 becomes GV2 ME086.

#### Thermal magnetic circuit-breakers GV2 ME with built-in auxiliary contact block

With instantaneous auxiliary contact block (composition, see page 24512/3):

■ GV AE1, add suffix **AE1TQ** to the motor circuit-breaker reference selected above.

Example: **GV2 ME01AE1TQ**.

■ GV AE11, add suffix **AE11TQ** to the motor circuit-breaker reference selected above.

Example: **GV2 ME01AE11TQ**.

■ GV AN11, add suffix **AN11TQ** to the motor circuit-breaker reference selected above.

Example: **GV2 ME01AN11TQ**.

These circuit-breakers with built-in contact block are sold in lots of 20 units in a single pack.

(1) As % of Icu.

(2) The thermal trip setting must be within the range marked on the graduated knob.

(3) Maximum rating which can be mounted in enclosures **GV2 MC** or **MP**, please consult your Regional Sales Office.

★ > 100 kA.



533897



GV2 ME003

#### Motor circuit-breakers from 0.06 to 11 kW, with spring terminal connections

##### GV2 ME (1) with pushbutton control

Standard power ratings of 3-phase motors 50-60 Hz in category AC-3						Setting range of thermal trips (3)	Magnetic tripping current I <sub>d</sub> ± 20 %	Reference	Weight
400/415 V			500 V						
P	I <sub>cu</sub>	I <sub>cs</sub> (2)	P	I <sub>cu</sub>	I <sub>cs</sub> (2)				
kW	kA	%	kW	kA	%	A	A	kg	
–	–	–	–	–	–	0.1...0.16	1.5	GV2 ME013	0.280
0.06	★	★	–	–	–	0.16...0.25	2.4	GV2 ME023	0.280
0.09	★	★	–	–	–	0.25...0.40	5	GV2 ME033	0.280
0.12	★	★	–	–	–	0.40...0.63	8	GV2 ME043	0.280
0.18	★	★	–	–	–	0.63...1	13	GV2 ME053	0.280
0.25	★	★	0.37	★	★	1...1.6	22.5	GV2 ME063	0.280
0.37	★	★	0.55	★	★	1.6...2.5	33.5	GV2 ME073	0.280
0.55	★	★	0.75	★	★	2.5...4	51	GV2 ME083	0.280
0.75	★	★	1.1	★	★	4...6.3	78	GV2 ME103	0.280
1.1	★	★	1.5	★	★	6...10	138	GV2 ME143	0.280
1.5	★	★	2.2	★	★	10...16	170	GV2 ME163	0.280
2.2	★	★	3	50	100	13...18	223	GV2 ME203	0.280
3	★	★	4	10	100	17...23	327	GV2 ME213	0.260
4	★	★	5.5	10	100	20...25	327	GV2 ME223	0.260
5.5	15	50	7.5	6	75				
7.5	15	50	9	6	75				
9	15	40	11	4	75				
11	15	40	15	4	75				
11	15	40	15	4	75				

#### Contact blocks

Description	Mounting	Maximum number	Type of contacts	Sold in lots of	Unit reference	Weight kg
Instantaneous auxiliary contacts	Front	1	N/O + N/C	10	GV AE113	0.030
			N/O + N/O	10	GV AE203	0.030
	LH side	2	N/O + N/C	1	GV AN113	0.060
			N/O + N/O	1	GV AN203	0.060

#### Accessory

Description	Application	Sold in lots of	Unit reference	Weight kg
Cable end reducer	For connection of conductors from 1 to 1.5 mm <sup>2</sup>	20	LA9 D99	–

(1) For connection of conductors from 1 to 1.5 mm<sup>2</sup>, the use of an LA9 D99 cable end reducer is recommended.

(2) Maximum rating which can be mounted in enclosures GV2 MC or MP, please consult your Regional Sales Office

(3) The thermal trip setting must be within the range marked on the graduated knob.

★ > 100 kA.

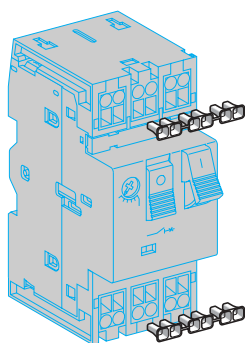

LA9 D99

# TeSys protection components

## Thermal-magnetic motor circuit-breakers

### GV2 P, GV3 P and GV3 ME80



GV2 P



GV3 P

#### Motor circuit-breakers from 0.06 to 30 kW / 400 V

Standard power ratings of 3-phase motors  
50/60 Hz in category AC-3

400/415 V			500 V			690 V			Setting range of thermal trips	Magnetic tripping current Id ± 20 %	Reference	Weight
P	Icu	Ics (1)	P	Icu	Ics (1)	P	Icu	Ics (1)				
kW	kA	%	kW	kA	%	kW	kA	%	A	A	kg	
<b>GV2 P: control by rotary knob</b>												
Screw clamp terminals												
–	–	–	–	–	–	–	–	–	0.1...0.16	1.5	<b>GV2 P01</b>	0.350
<b>0.06</b>	★	★	–	–	–	–	–	–	0.16...0.25	2.4	<b>GV2 P02</b>	0.350
<b>0.09</b>	★	★	–	–	–	–	–	–	0.25...0.40	5	<b>GV2 P03</b>	0.350
<b>0.12</b>	★	★	–	–	–	<b>0.37</b>	★	★	0.40...0.63	8	<b>GV2 P04</b>	0.350
<b>0.18</b>	★	★	–	–	–	–	–	–	–	–	–	–
<b>0.25</b>	★	★	–	–	–	<b>0.55</b>	★	★	0.63...1	13	<b>GV2 P05</b>	0.350
<b>0.37</b>	★	★	<b>0.37</b>	★	★	–	–	–	1...1.6	22.5	<b>GV2 P06</b>	0.350
<b>0.55</b>	★	★	<b>0.55</b>	★	★	<b>0.75</b>	★	★	–	–	–	–
<b>0.75</b>	★	★	<b>1.1</b>	★	★	<b>1.5</b>	8	100	1.6...2.5	33.5	<b>GV2 P07</b>	0.350
<b>1.1</b>	★	★	<b>1.5</b>	★	★	<b>2.2</b>	8	100	2.5...4	51	<b>GV2 P08</b>	0.350
<b>2.2</b>	★	★	<b>3</b>	★	★	<b>4</b>	6	100	4...6.3	78	<b>GV2 P10</b>	0.350
<b>3</b>	★	★	<b>5</b>	50	100	<b>5.5</b>	6	100	6...10	138	<b>GV2 P14</b>	0.350
<b>5.5</b>	★	★	<b>7.5</b>	42	75	<b>9</b>	6	100	9...14	170	<b>GV2 P16</b>	0.350
–	–	–	–	–	–	<b>11</b>	6	100	–	–	–	–
<b>7.5</b>	50	50	<b>9</b>	10	75	<b>15</b>	4	100	13...18	223	<b>GV2 P20</b>	0.350
<b>9</b>	50	50	<b>11</b>	10	75	<b>18.5</b>	4	100	17...23	327	<b>GV2 P21</b>	0.350
<b>11</b>	50	50	<b>15</b>	10	75	–	–	–	20...25	327	<b>GV2 P22</b>	0.350
<b>15</b>	35	50	<b>18.5</b>	10	75	<b>22</b>	4	100	24...32	416	<b>GV2 P32</b>	0.350

#### GV3 P: control by rotary knob

Connection by EverLink® BTR screw connectors (3)

<b>5.5</b>	100	50	<b>7.5</b>	12	50	<b>11</b>	6	50	9...13	182	<b>GV3 P13</b>	1.000
<b>7.5</b>	100	50	<b>9</b>	12	50	<b>15</b>	6	50	12...18	252	<b>GV3 P18</b>	1.000
<b>11</b>	100	50	<b>15</b>	12	50	<b>18.5</b>	6	50	17...25	350	<b>GV3 P25</b>	1.000
<b>15</b>	100	50	<b>18.5</b>	12	50	<b>22</b>	6	50	23...32	448	<b>GV3 P32</b>	1.000
<b>18.5</b>	50	50	<b>22</b>	10	50	<b>37</b>	5	60	30...40	560	<b>GV3 P40</b>	1.000
<b>22</b>	50	50	<b>30</b>	10	50	<b>45</b>	5	60	37...50	700	<b>GV3 P50</b>	1.000
<b>30</b>	50	50	<b>45</b>	10	50	<b>55</b>	5	60	48...65	910	<b>GV3 P65</b>	1.000

#### Connection by lugs

To order thermal magnetic circuit-breakers with connection by lugs, add the digit **6** to the end of reference selected above. Example: **GV3 P18** becomes **GV3 P186**.

#### GV3 ME80: pushbutton control, screw clamp terminals

<b>37</b>	15	50	<b>45</b>	4	100	<b>55</b>	2	100	56...80		<b>GV3 ME80 (4)</b>	0.700
-----------	----	----	-----------	---	-----	-----------	---	-----	---------	--	---------------------	-------

#### Motor circuit-breakers up to 50 hp / 600 V, UL 508 type E

##### GV2 (5)

To obtain a GV2 P motor circuit-breaker, UL 508 type E, combine :

- a circuit-breaker **GV2 P●●H7** (except 32 A),
- and a "Large Spacing" adapter **GV2 GH7**.

##### GV3 (6)

To obtain a motor-circuit-breaker GV3 P, UL 508 type E, use the following with the circuit-breaker:

- a "Large Spacing" cover **GV3 G66**,
- a short-circuit signalling contact **GV AM11**.

##### GV3 with connection by lugs (6)

To obtain a motor-circuit-breaker GV3 P, UL 508 type E, with connection by lugs, add the digit **6** to the end of reference selected above and use the following with the circuit-breaker :

- two IP 20 covers **LAD 96570**,
- a short-circuit signalling contact **GV AM11**.

(1) As % of Icu.

(2) The thermal trip setting must be within the range marked on the graduated knob.

(3) BTR screws: hexagon socket head. Require use of an insulated Allen key, in compliance with local wiring regulations.

(4) Recommended for use in association with a contactor.

(5) Accessory: see page 24512/11.

(6) Accessories: see page 24512/5.

★ > 100 kA.

# TeSys protection components

## Thermal-magnetic motor circuit-breakers

### GV7 R



GV7 RE

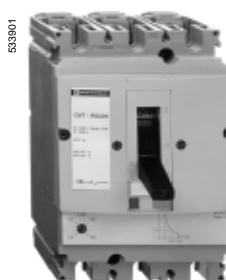

GV7 RS

#### Thermal-magnetic circuit-breakers GV7 R with screw clamp terminals

##### Control by rocker lever

Standard power ratings of 3-phase motors 50/60 Hz in category AC-3									Setting range of thermal trips	Reference	Weight
400/415 V			500 V			660/690 V					
P	Icu	Ics (1)	P	Icu	Ics (1)	P	Icu	Ics (1)			
kW	kA	%	kW	kA	%	kW	kA	%	A		kg
7.5	36	100	9	18	100	11	8	100	12...20	GV7 RE20	2.010
9	36	100	11	18	100	15	8	100			
7.5	70	100	9	50	100	11	10	100	12...20	GV7 RS20	2.010
9	70	100	11	50	100	15	10	100			
9	36	100	11	18	100	15	8	100	15...25	GV7 RE25	2.010
11	36	100	15	18	100	18.5	8	100			
9	70	100	11	50	100	15	10	100	15...25	GV7 RS25	2.010
11	70	100	15	50	100	18.5	10	100			
18.5	36	100	18.5	18	100	22	8	100	25...40	GV7 RE40	2.010
			22	18	100						
18.5	70	100	18.5	50	100	22	10	100	25...40	GV7 RS40	2.010
22	36	100	30	18	100	30	8	100	30...50	GV7 RE50	2.015
22	70	100	30	50	100	30	10	100	30...50	GV7 RS50	2.015
37	36	100	45	18	100	55	8	100	48...80	GV7 RE80	2.040
			55	18	100						
37	70	100	45	50	100	55	10	100	48...80	GV7 RS80	2.040
			55	50	100						
45	36	100	–	18	100	75	8	100	60...100	GV7 RE100	2.040
45	70	100	–	50	100	75	10	100	60...100	GV7 RS100	2.040
55	35	100	75	30	100	90	8	100	90...150	GV7 RE150	2.020
75	35	100	90	30	100	110	8	100			
55	70	100	75	50	100	90	10	100	90...150	GV7 RS150	2.020
75	70	100	90	50	100	110	10	100			
90	35	100	110	30	100	160	8	100	132...220	GV7 RE220	2.350
110	35	100	132	30	100	200	8	100			
			160	30	100						
90	70	100	110	50	100	160	10	100	132...220	GV7 RS220	2.350
110	70	100	132	50	100	200	10	100			
			160	50	100						

(1) As % of Icu.

# TeSys protection components

## Thermal-magnetic circuit-breakers

### GV2 RT

510570



GV2 RT

#### For motors with high current peak on starting

##### Control by rocker lever

Standard power ratings of 3-phase motors 50-60 Hz in category AC-3					Setting range of thermal trips (1)	Magnetic tripping current I <sub>d</sub> ± 20 %	Reference	Weight
220/ 230 V	400/ 415 V	440 V	500 V	690 V				
kW	kW	kW	kW	kW	A	A		kg
0.06	0.09	0.09 0.12	–	–	0.25...0.40	8	<b>GV2 RT03</b>	0.350
–	0.12 0.18	0.18	–	0.37	0.40...0.63	13	<b>GV2 RT04</b>	0.350
0.09 0.12	0.25 0.37	0.25 0.37	0.37	0.55	0.63...1	22	<b>GV2 RT05</b>	0.350
0.18 0.25	0.37 0.55	0.37 0.55	0.37 0.55 0.75	0.75 1.1	1...1.6	33	<b>GV2 RT06</b>	0.350
0.37	0.75	0.75 1.1	1.1	1.5	1.6...2.5	51	<b>GV2 RT07</b>	0.350
0.55 0.75	1.1 1.5	1.5	1.5 2.2	2.2 3	2.5...4	78	<b>GV2 RT08</b>	0.350
1.1	2.2	2.2 3	3	4	4...6.3	138	<b>GV2 RT10</b>	0.350
1.5 2.2	3 4	4	4 5.5	5.5 7.5	6...10	200	<b>GV2 RT14</b>	0.350
2.2 3	5.5	5.5 7.5	7.5	9 11	9...14	280	<b>GV2 RT16</b>	0.350
4	7.5	7.5 9	9	15	13...18	400	<b>GV2 RT20</b>	0.350
5.5	9 11	11	11	18.5	17...23	400	<b>GV2 RT21</b>	0.350

(1) The thermal trip setting must be within the range marked on the graduated knob.

5105770



GV2 RT

## For primaries of 3-phase transformers

## Control by rocker lever

Standard power ratings					Setting range of thermal trips (1)	Magnetic tripping current $I_d \pm 20\%$	Reference	Weight
230/240 V	400/415 V	440 V	500 V	690 V				
kW	kW	kW	kW	kW	A	A		kg
-	-	-	-	-	0.25...0.40	8	GV2 RT03	0.350
-	-	-	-	-	0.40...0.63	13	GV2 RT04	0.350
-	-	0.63	0.63	1	0.63...1	22	GV2 RT05	0.350
0.4	0.63	1	1	-	1...1.6	33	GV2 RT06	0.350
0.63	1	-	1.6	1.6 2	1.6...2.5	51	GV2 RT07	0.350
1	1.6 2	1.6 2	2 2.5	2.5	2.5...4	78	GV2 RT08	0.350
1.6 2	2.5	2.5 4	4	4 5 6.3	4...6.3	138	GV2 RT10	0.350
2.5	4 5	5	5 6.3	-	6...10	200	GV2 RT14	0.350
4	6.3	6.3	-	10 12.5	9...14	280	GV2 RT16	0.350
5 6.3	10	10	10 12.5	10	13...18	400	GV2 RT20	0.350

## Accessory (2)

Description	Reference	Weight kg
Padlockable external operator (IP 54) black handle, blue legend plate	GV2 AP03	0.280

(1) The thermal trip setting must be within the range marked on the graduated knob.

(2) Other accessories such as mounting, cabling and marking accessories are identical to those used for GV2 ME motor circuit-breakers, see page 24512/9.

# TeSys protection components

## Magnetic motor circuit-breakers

### GV2 LE

534101



GV2 LE

#### Magnetic motor circuit-breakers from 0.06 to 15 kW

GV2 L: control by rocker lever, connection by screw clamp terminals

Standard power ratings of 3-phase motors  
50/60 Hz in category AC-3

Standard power ratings of 3-phase motors 50/60 Hz in category AC-3									Magnetic protection rating	Tripping current I <sub>d</sub> ± 20 %	Use in association with thermal overload relay	Reference	Weight
400/415 V			500 V			690 V							
P	I <sub>cu</sub>	I <sub>cs</sub> (1)	P	I <sub>cu</sub>	I <sub>cs</sub> (1)	P	I <sub>cu</sub>	I <sub>cs</sub> (1)	A	A			kg
0.06	★	★	-	-	-	-	-	-	0.4	5	LR2 K0302	<b>GV2 LE03</b>	0.330
0.09	★	★	-	-	-	-	-	-	0.4	5	LR2 K0304	<b>GV2 LE03</b>	0.330
0.12	★	★	-	-	-	0.37	★	★	0.63	8	LR2 K0304	<b>GV2 LE04</b>	0.330
0.18	★	★	-	-	-	-	-	-	0.63	8	LR2 K0305	<b>GV2 LE04</b>	0.330
-	-	-	-	-	-	0.55	★	★	1	13	LR2 K0305	<b>GV2 LE05</b>	0.330
0.25	★	★	-	-	-	-	-	-	1	13	LR2 K0306	<b>GV2 LE05</b>	0.330
-	-	-	-	-	-	0.75	★	★	1	13	LR2 K0306	<b>GV2 LE05</b>	0.330
0.37	★	★	0.37	★	★	-	-	-	1	13	LR2 K0306	<b>GV2 LE05</b>	0.330
0.55	★	★	0.55	★	★	1.1	★	★	1.6	22.5	LR2 K0307	<b>GV2 LE06</b>	0.330
-	-	-	0.75	★	★	-	-	-	1.6	22.5	LR2 K0307	<b>GV2 LE06</b>	0.330
0.75	★	★	1.1	★	★	1.5	3	75	2.5	33.5	LR2 K0308	<b>GV2 LE07</b>	0.330
1.1	★	★	-	-	-	-	-	-	2.5	33.5	LR2 K0308	<b>GV2 LE07</b>	0.330
1.5	★	★	1.5	★	★	3	3	75	4	51	LR2 K0310	<b>GV2 LE08</b>	0.330
-	-	-	2.2	★	★	-	-	-	4	51	LR2 K0312	<b>GV2 LE08</b>	0.330
2.2	★	★	3	50	100	4	3	75	6.3	78	LR2 K0312	<b>GV2 LE10</b>	0.330
3	★	★	4	10	100	5.5	3	75	10	138	LR2 K0314	<b>GV2 LE14</b>	0.330
4	★	★	5.5	10	100	-	-	-	10	138	LR2 K0316	<b>GV2 LE14</b>	0.330
-	-	-	-	-	-	7.5	3	75	10	138	LRD 14	<b>GV2 LE14</b>	0.330
-	-	-	-	-	-	9	3	75	14	170	LRD 16	<b>GV2 LE16</b>	0.330
5.5	15	50	7.5	6	75	11	3	75	14	170	LR2 K0321	<b>GV2 LE16</b>	0.330
7.5	15	50	9	6	75	15	3	75	18	223	LRD 21	<b>GV2 LE20</b>	0.330
9	15	40	11	4	75	18.5	3	75	25	327	LRD 22	<b>GV2 LE22</b>	0.330
11	15	40	15	4	75	-	-	-	25	327	LRD 22	<b>GV2 LE22</b>	0.330
15	10	50	18.5	4	75	22	3	75	32	416	LRD 32	<b>GV2 LE32</b>	0.330

(1) As % of I<sub>cu</sub>.

★ > 100 kA.

## TeSys protection components

## Magnetic motor circuit-breakers

## GV2 L, GV3 L and GK3 EF80

534102



GV2 ●●

510631



GV3 L●●

534103



GK3 EF80

## Motor circuit-breakers from 0.09 to 30 kW

## GV2 L: Control by rotary knob, connection by screw clamp terminals

Standard power ratings of 3-phase motors 50/60 Hz in category AC-3									Magnetic protection rating	Tripping current I <sub>d</sub> ± 20 %	Use in association with thermal overload relay	Reference	Weight
400/415 V			500 V			690 V							
P	I <sub>cu</sub>	I <sub>cs</sub> (1)	P	I <sub>cu</sub>	I <sub>cs</sub> (1)	P	I <sub>cu</sub>	I <sub>cs</sub> (1)	A	A			kg
0.09	★	★	-	-	-	-	-	-	0.4	5	LRD 03	GV2 L03	0.330
0.12	★	★	-	-	-	0.37	★	★	0.63	8	LRD 04	GV2 L04	0.330
0.18	★	★	-	-	-	-	-	-	0.63	8	LRD 04	GV2 L04	0.330
-	-	-	-	-	-	0.55	★	★	1	13	LRD 05	GV2 L05	0.330
0.25	★	★	-	-	-	-	-	-	1	13	LRD 05	GV2 L05	0.330
-	-	-	-	-	-	0.75	★	★	1	13	LRD 06	GV2 L05	0.330
0.37	★	★	0.37	★	★	-	-	-	1	13	LRD 05	GV2 L05	0.330
0.55	★	★	0.55	★	★	1.1	★	★	1.6	22.5	LRD 06	GV2 L06	0.330
-	-	-	0.75	★	★	-	-	-	1.6	22.5	LRD 06	GV2 L06	0.330
0.75	★	★	1.1	★	★	1.5	4	100	2.5	33.5	LRD 07	GV2 L07	0.330
1.1	-	-	-	-	-	-	-	-	-	-	LRD 08	GV2 L08	0.330
1.5	★	★	1.5	★	★	3	4	100	4	51	LRD 08	GV2 L08	0.330
-	-	-	-	-	-	-	-	-	-	-	LRD 08	GV2 L08	0.330
2.2	★	★	3	★	★	4	4	100	6.3	78	LRD 10	GV2 L10	0.330
3	★	★	4	10	100	5.5	4	100	10	138	LRD 12	GV2 L14	0.330
4	-	-	-	-	-	-	-	-	-	-	LRD 14	GV2 L14	0.330
-	-	-	-	-	-	7.5	4	100	10	138	LRD 14	GV2 L14	0.330
-	-	-	-	-	-	9	4	100	14	170	LRD 16	GV2 L16	0.330
5.5	50	50	7.5	10	75	11	4	100	14	170	LRD 16	GV2 L16	0.330
7.5	50	50	9	10	75	15	4	100	18	223	LRD 21	GV2 L20	0.330
9	50	50	11	10	75	18.5	4	100	25	327	LRD 22	GV2 L22	0.330
11	50	50	15	10	75	-	-	-	25	327	LRD 22	GV2 L22	0.330
15	35	50	18.5	10	75	22	4	100	32	416	LRD 32	GV2 L32	0.330

## GV3 L: control by rotary knob, connection by EverLink® BTR screw connector

Standard power ratings of 3-phase motors 50/60 Hz in category AC-3									Magnetic protection rating	Tripping current I <sub>d</sub> ± 20 %	Use in association with thermal overload relay (class 10 A)	Reference	Weight
400/415 V			500 V			690 V							
P	I <sub>cu</sub>	I <sub>cs</sub> (1)	P	I <sub>cu</sub>	I <sub>cs</sub> (1)	P	I <sub>cu</sub>	I <sub>cs</sub> (1)	A	A			kg
11	100	50	15	12	50	18,5	6	50	25	350	LRD 22	GV3 L25	1.000
15	100	50	18.5	12	50	22	6	50	32	448	LRD 32	GV3 L32	1.000
18,5	50	50	22	10	50	37	5	60	40	560	LRD 3355	GV3 L40	1.000
22	50	50	30	10	50	45	5	60	50	700	LRD 3357	GV3 L50	1.000
30	50	50	37	10	50	55	5	60	65	910	LRD 3359	GV3 L65	1.000

## Connection by lugs

To order these circuit-breakers with connection by lugs, add the digit **6** to the end of reference selected above.  
Example: **GV3 L32** becomes **GV3 L326**.

## GK3: control by rotary knob, connection by screw clamp terminals

37	35	25	55	15	30	-	-	-	80	1040	LRD3363	GK3 EF80	0,795
----	----	----	----	----	----	---	---	---	----	------	---------	----------	-------

(1) As % of I<sub>cu</sub>.

(2) Associated current limiter or fuses, where required. See characteristics page 24523/5.

★ > 100 kA.

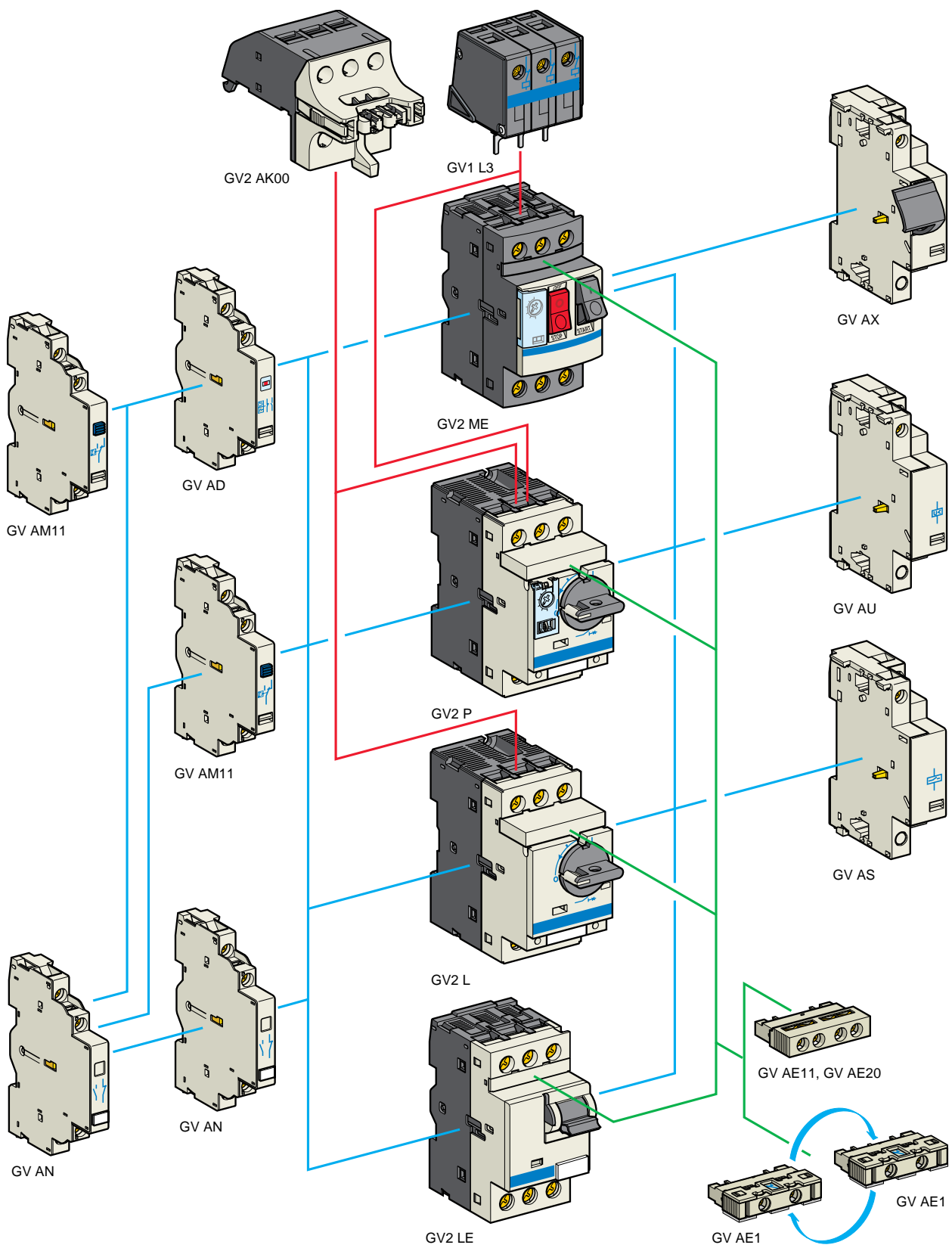



# TeSys protection components

## Thermal-magnetic and magnetic motor circuit-breakers GV2 with screw clamp connections

### Add-on blocks and accessories

#### Contact blocks

Description	Mounting	Maximum number	Type of contacts	Sold in lots of	Unit reference	Weight kg	
Instantaneous auxiliary contacts	Front (1)	1	N/O or N/C (2)	10	GV AE1	0.015	
			N/O + N/C	10	GV AE11	0.020	
	Side (LH)	2	N/O + N/O	10	GV AE20	0.020	
			N/O + N/C	1	GV AN11	0.050	
Fault signalling contact + instantaneous auxiliary contact	Side (LH) (3)	1	N/O (fault)	+ N/O	1	GV AD1010	0.055
				+ N/C	1	GV AD1001	0.055
			N/C (fault)	+ N/O	1	GV AD0110	0.055
				+ N/C	1	GV AD0101	0.055
Short-circuit signalling contact	Side (LH)	1	C/O common point	1	GV AM11	0.045	

#### Electric trips

Mounting	Voltage		Reference	Weight kg
<b>Undervoltage or shunt trips (4)</b>				
Side (1 block on RH side of circuit-breaker)	24 V	50 Hz	GV A●025	0.105
		60 Hz	GV A●026	0.105
	48 V	50 Hz	GV A●055	0.105
		60 Hz	GV A●056	0.105
	100 V	50 Hz	GV A●107	0.105
	100...110 V	60 Hz	GV A●107	0.105
	110...115 V	50 Hz	GV A●115	0.105
		60 Hz	GV A●116	0.105
	120...127 V	50 Hz	GV A●125	0.105
	127 V	60 Hz	GV A●115	0.105
	200 V	50 Hz	GV A●207	0.105
	200...220 V	60 Hz	GV A●207	0.105
	220...240 V	50 Hz	GV A●225	0.105
		60 Hz	GV A●226	0.105
	380...400 V	50 Hz	GV A●385	0.105
		60 Hz	GV A●386	0.105
	415...440 V	50 Hz	GV A●415	0.105
	415 V	60 Hz	GV A●416	0.105
	440 V	60 Hz	GV A●385	0.105
	480 V	60 Hz	GV A●415	0.105
500 V	50 Hz	GV A●505	0.105	
600 V	60 Hz	GV A●505	0.105	

#### Undervoltage trip, INRS (can only be mounted on GV2 ME)

Safety device for dangerous machines conforming to INRS and VDE 0113.

Side (1 block on RH side of circuit-breaker GV2 ME)	110...115 V	50 Hz	GV AX115	0.110
		60 Hz	GV AX116	0.110
	127 V	60 Hz	GV AX115	0.110
		50 Hz	GV AX225	0.110
	220...240 V	60 Hz	GV AX226	0.110
		50 Hz	GV AX385	0.110
	380...400 V	60 Hz	GV AX386	0.110
		50 Hz	GV AX415	0.110
	415...440 V	50 Hz	GV AX415	0.110
	440 V	60 Hz	GV AX385	0.110

#### Add-on contact blocks

Description	Mounting	Maximum number	Reference	Weight kg
Visible isolation block (5)	Front (1)	1	GV2 AK00	0.150
Limiters	At top (GV2 ME and GV2 P)	1	GV1 L3	0.130
	Independent	1	LA9 LB920	0.320

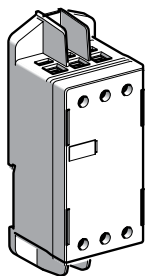

LA9 LB920

(1) Mounting of a GV AE contact block or a GV2 AK00 visible isolation block on GV2 P and GV2 L

(2) Choice of N/C or N/O contact operation, depending on which way round the reversible block is mounted.

(3) The GV AD is always mounted next to the circuit-breaker.

(4) To order an undervoltage trip: replace the dot (●) in the reference with a U, example: GV AU025.

To order a shunt trip: replace the dot (●) in the reference with an S, example: GV AS025.

(5) Visible isolation of the 3 poles upstream of circuit-breaker GV2 P and GV2 L.

Visible isolation block GV2 AK00 cannot be used with motor circuit-breakers GV2 P32 and GV2 L32 (Ith max = 25 A).

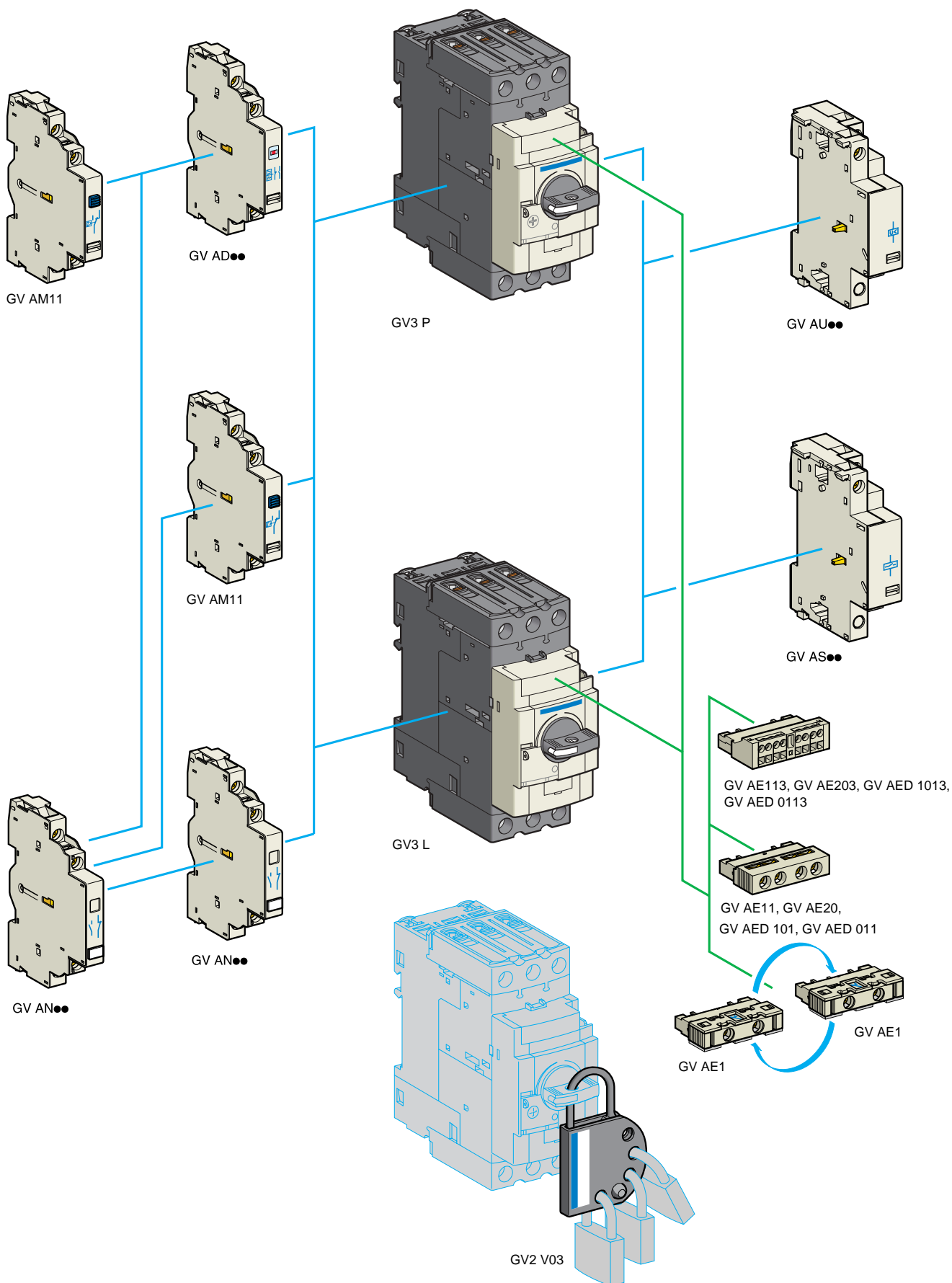

## TeSys protection components

Thermal-magnetic motor circuit-breakers

GV3 P and GV3 L

Add-on blocks and accessories

## Contact blocks

Description	Mounting	Maximum number	Type of contacts	Sold in lots of	Unit reference	Weight kg
Instantaneous auxiliary contacts	Front	1	N/O or N/C (1)	10	GV AE1	0.015
			N/O + N/C	10	GV AE11 (2)	0.020
	Side (LH)	2	N/O + N/C	1	GV AN11 (2)	0.050
			N/O + N/O	1	GV AN20 (2)	0.050
Fault signalling contact + instantaneous auxiliary contact	Front	1	N/O (fault) + N/O	1	GV AED101 (2)	0.020
			N/O (fault) + N/C	1	GV AED011 (2)	0.020
	Side (3) (LH)	1	N/O (fault) + N/O	1	GV AD1010	0.055
			+ N/C	1	GV AD1001	0.055
			N/C (fault) + N/O	1	GV AD0110	0.055
			+ N/C	1	GV AD0101	0.055
Short-circuit signalling contact	Side (LH)	1	C/O common point	1	GV AM11	0.045

## Electric trips

Mounting	Voltage		Reference	Weight kg
<b>Undervoltage or shunt trips (4)</b>				
Side (1 block on RH side of circuit-breaker)	24 V	50 Hz	GV A●025	0.105
		60 Hz	GV A●026	0.105
	48 V	50 Hz	GV A●055	0.105
		60 Hz	GV A●056	0.105
	100	50 Hz	GV A●107	0.105
	100...110 V	60 Hz	GV A●107	0.105
	110...115 V	50 Hz	GV A●115	0.105
		60 Hz	GV A●116	0.105
	120...127 V	50 Hz	GV A●125	0.105
	127 V	60 Hz	GV A●115	0.105
	200 V	50 Hz	GV A●207	0.105
	200...220 V	60 Hz	GV A●207	0.105
		220...240 V	50 Hz	GV A●225
	60 Hz		GV A●226	0.105
	380...400 V	50 Hz	GV A●385	0.105
		60 Hz	GV A●386	0.105
	415...440 V	50 Hz	GV A●415	0.105
	415 V	60 Hz	GV A●416	0.105
	440 V	60 Hz	GV A●385	0.105
480 V	60 Hz	GV A●415	0.105	
500 V	50 Hz	GV A●505	0.105	
600 V	60 Hz	GV A●505	0.105	

## Accessories

Description	For circuit-breakers	Reference	Weight kg
Set of 3-pole 115 A busbars 3 tap-offs. Pitch: 64 mm	GV3 P●● and GV3 L●●	GV3 G364	0.25
Cover "Large Spacing" UL 508 type E (Only one cover required on supply side)	GV3 P●●	GV3 G66	0.020
IP 20 cover (Two covers required per breaker)	GV3 P●●6 and GV3 L●●6	LAD 96570	0.021
Padlocking device for use with up to 4 padlocks (not supplied) Ø 6 mm shank max.	GV3 P●● and GV3 L●● GV3 P●●6 and GV3 L●●6	GV2 V03	0.092

(1) Choice of N/C or N/O contact operation, depending on which way round the reversible block is mounted.

(2) Contact blocks available in version with spring terminal connections. Add a figure 3 at the end of the references selected above.

Example: GV AED101 becomes GV AED1013.

(3) The GV AD is always mounted next to the circuit-breaker.

(4) To order an undervoltage trip: replace the dot (●) in the reference with a U, example: GV AU025.

To order a shunt trip: replace the dot (●) in the reference with an S, example: GV AS025.

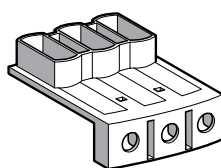

GV3 G66

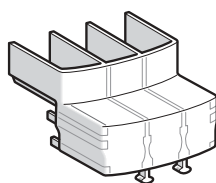

LAD 96570

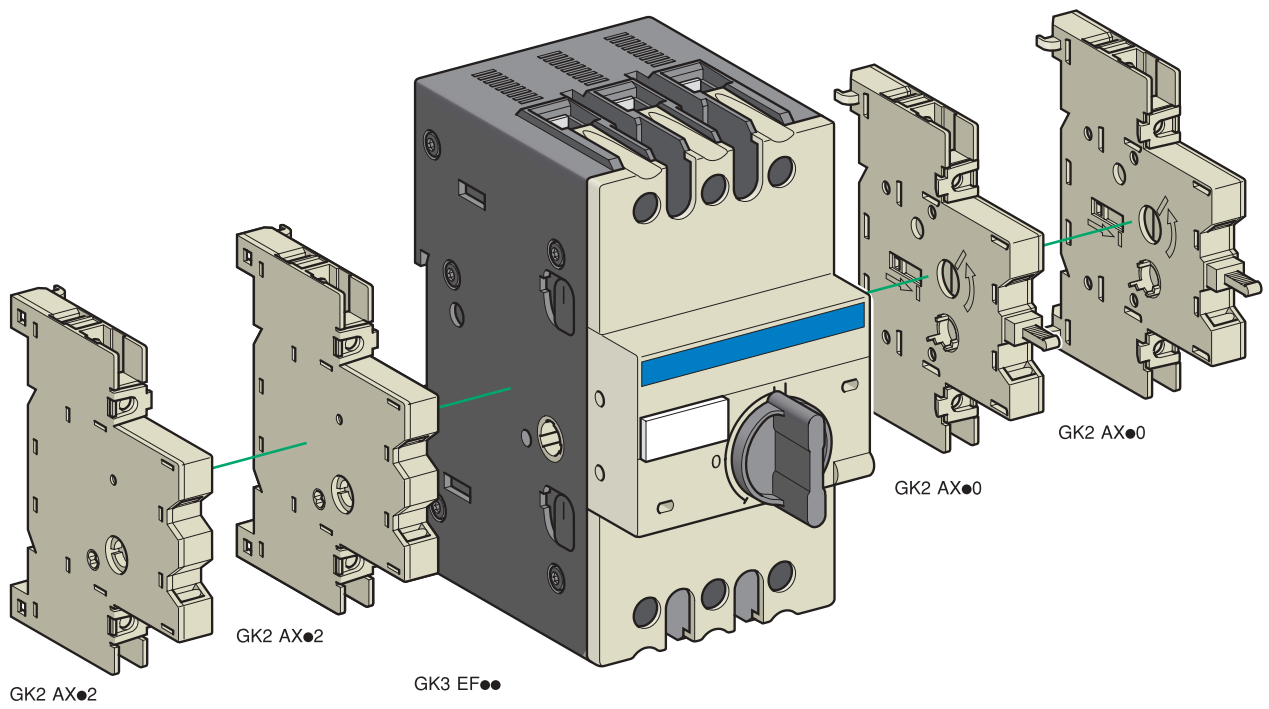
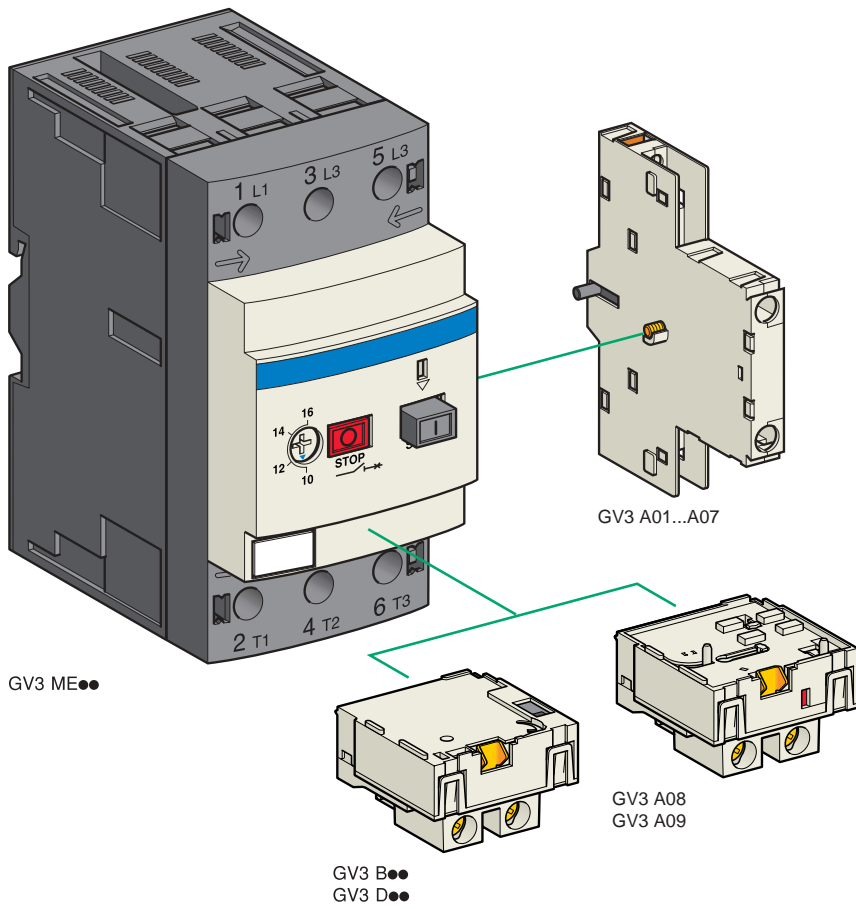

# TeSys protection components

## Motor circuit-breakers GV3 ME80 and

## GK3 EF80

### Add-on blocks and accessories

#### For thermal-magnetic motor circuit-breakers GV3 ME80

##### Contact blocks

Description	Type of standard early break contacts	Reference	Weight kg
Instantaneous auxiliary contact blocks (1 per circuit-breaker)	N/C + N/O	GV3 A01	0.060
	N/O + N/O	GV3 A02	0.060
	N/C + N/O + N/O	GV3 A03	0.070
	N/O + N/O + N/O	GV3 A05	0.070
	N/O + N/O + 2 volt-free terminals	GV3 A06	0.070
	N/C + N/O + 2 volt-free terminals	GV3 A07	0.070
Fault signalling contacts (1)	N/C	GV3 A08	0.030
	N/O	GV3 A09	0.030

##### Electric trips

Description	Voltages		Reference	Weight kg
	50 Hz	60 Hz		
Undervoltage trips (1)	110, 120, 127 V	120, 127 V	GV3 B11	0.070
	220, 240 V	277 V	GV3 B22	0.070
	380, 415 V	440 V, 480 V	GV3 B38	0.070
Shunt trips (1)	110, 120, 127 V	120, 127 V	GV3 D11	0.070
	220, 240 V	277 V	GV3 D22	0.070
	380, 415 V	440 V, 480 V	GV3 D38	0.070

##### Accessory

Description	Sold in lots of	Unit reference	Weight kg
Padlocking device, for locking the Start button (on open-mounted product)	5	GV1 V02	0.010

#### For magnetic circuit-breaker GK3 EF80

##### Contact blocks

Description	Number of poles	Reference	Weight kg
Auxiliary contact blocks for On-Off signalling and "control circuit test" function (1 or 2 blocks per device) mounted on RH side of GK3 EF80	N/O	GK2 AX10	0.025
	N/O + N/O	GK2 AX20	0.031
	N/C + N/O	GK2 AX50	0.031
Instantaneous fault signalling contact blocks (1 or 2 blocks per device) mounted on LH side of GK3 EF80	N/O	GK2 AX12	0.025
	N/O + N/O	GK2 AX22	0.031
	N/C + N/O	GK2 AX52	0.031

##### Accessories

Description	Reference	Weight kg
Padlocking device for padlocking the operator, using up to 3 padlocks (padlocks to be ordered separately)	GK3 AV01	0.020
External operator for mounting on enclosure door. Red Ø 40 knob on yellow plate, padlockable in position O (with up to 3 padlocks). Door locked when knob in position I, and when knob padlocked in position O.	GK3 AP03	0.300

(1) 1 voltage trip **OR** 1 fault signalling contact to be fitted inside the motor circuit-breaker.

##### Other versions

24 to 690 V, 50 or 60 Hz voltage trips for circuit-breakers **GV3 ME80**.  
Please consult your Regional Sales Office.

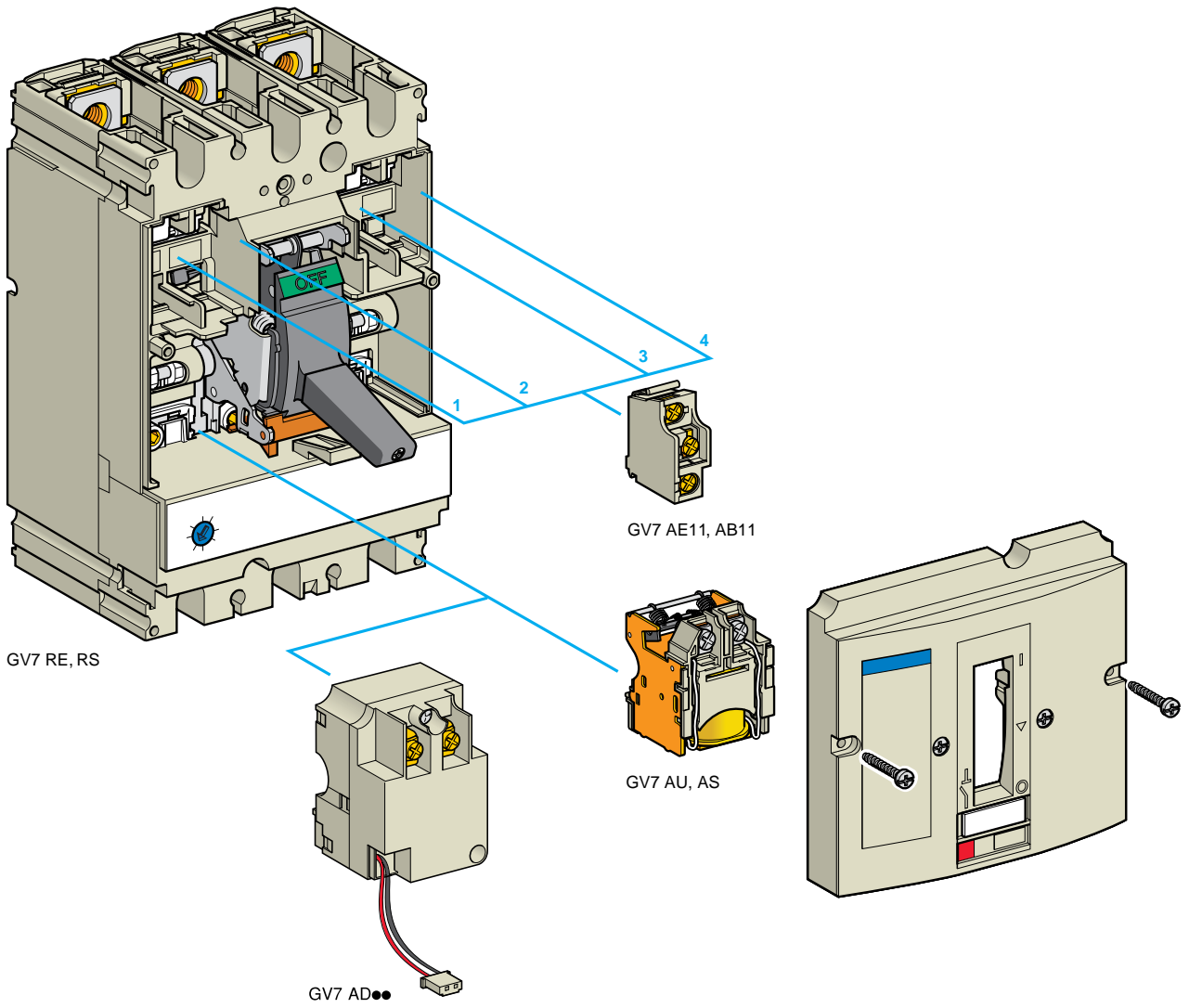

# TeSys protection components

## Thermal-magnetic motor circuit-breakers

### GV7 R with screw clamp connections

#### Add-on blocks and accessories

#### Add-on auxiliary contacts

These allow remote indication of the circuit-breaker contact states. They can be used for signalling, electrical locking, relaying, etc. They are available in two versions: standard and low level. They include a terminal block and the auxiliary circuits leave the circuit-breaker through a hole provided for this purpose. They perform the following functions, depending on where they are located in the circuit-breaker:

Location	Function	Application
1 and/or 4	C/O contact	Indicates the position of the circuit-breaker poles
2	Trip indication	Indicates that the circuit-breaker has tripped due to an overload, a short-circuit, a differential fault or the operation of a voltage trip (undervoltage or shunt trip), or of the "push to trip" test button. It resets when the circuit-breaker is reset.
3	Electrical fault indication	Indicates that the circuit-breaker has tripped due to an overload, a short-circuit or a differential fault. It resets when the circuit-breaker is reset.

Type	Reference	Weight kg
Standard	GV7 AE11	0.015
Low level	GV7 AB11	0.015

#### Fault discrimination devices

These make it possible to:

- either differentiate a thermal fault from a magnetic fault,
- or open the contactor only in the event of a thermal fault.

Voltage	Reference	Weight kg
$\sim$ 24...48 and $\equiv$ 24...72 V	GV7 AD111 (1)	0.100
$\approx$ 110...240 V	GV7 AD112 (1)	0.100

#### Electric trips

These allow the circuit-breaker to be tripped via an electrical control signal.

- Undervoltage trip GV7 AU
  - Trips the circuit-breaker when the control voltage drops below the tripping threshold, which is between 0.35 and 0.7 times the rated voltage.
  - Circuit-breaker closing is only possible if the voltage exceeds 0.85 times the rated voltage.
- Shunt trip GV7 AS
  - Trips the circuit-breaker when the control voltage rises above 0.7 times the rated voltage.
- Operation (GV7 AU or GV7 AS)
  - When the circuit-breaker has been tripped by a GV7 AU or AS, it must be reset either locally or by remote control. (For remote control, please consult your Regional Sales Office).
  - Tripping has priority over manual closing: if a tripping instruction is present, manual action does not result in closing, even temporarily, of the contacts.
  - Durability: 50 % of the mechanical durability of the circuit-breaker.

Type	Voltage	Reference	Weight kg
Undervoltage trip	48 V, 50/60 Hz	GV7 AU055 (1)	0.105
	110...130 V, 50/60 Hz	GV7 AU107 (1)	0.110
	200...240 V, 50/60 Hz	GV7 AU207 (1)	0.110
	380...440 V, 50/60 Hz	GV7 AU387 (1)	0.105
	525 V, 50 Hz	GV7 AU525 (1)	0.100
Shunt trip	48 V, 50/60 Hz	GV7 AS055 (1)	0.105
	110...130 V, 50/60 Hz	GV7 AS107 (1)	0.110
	200...240 V, 50/60 Hz	GV7 AS207 (1)	0.110
	380...440 V, 50/60 Hz	GV7 AS387 (1)	0.105
	525 V, 50 Hz	GV7 AS525 (1)	0.100

(1) For mounting of a GV7 AD or a GV7 AU or AS.

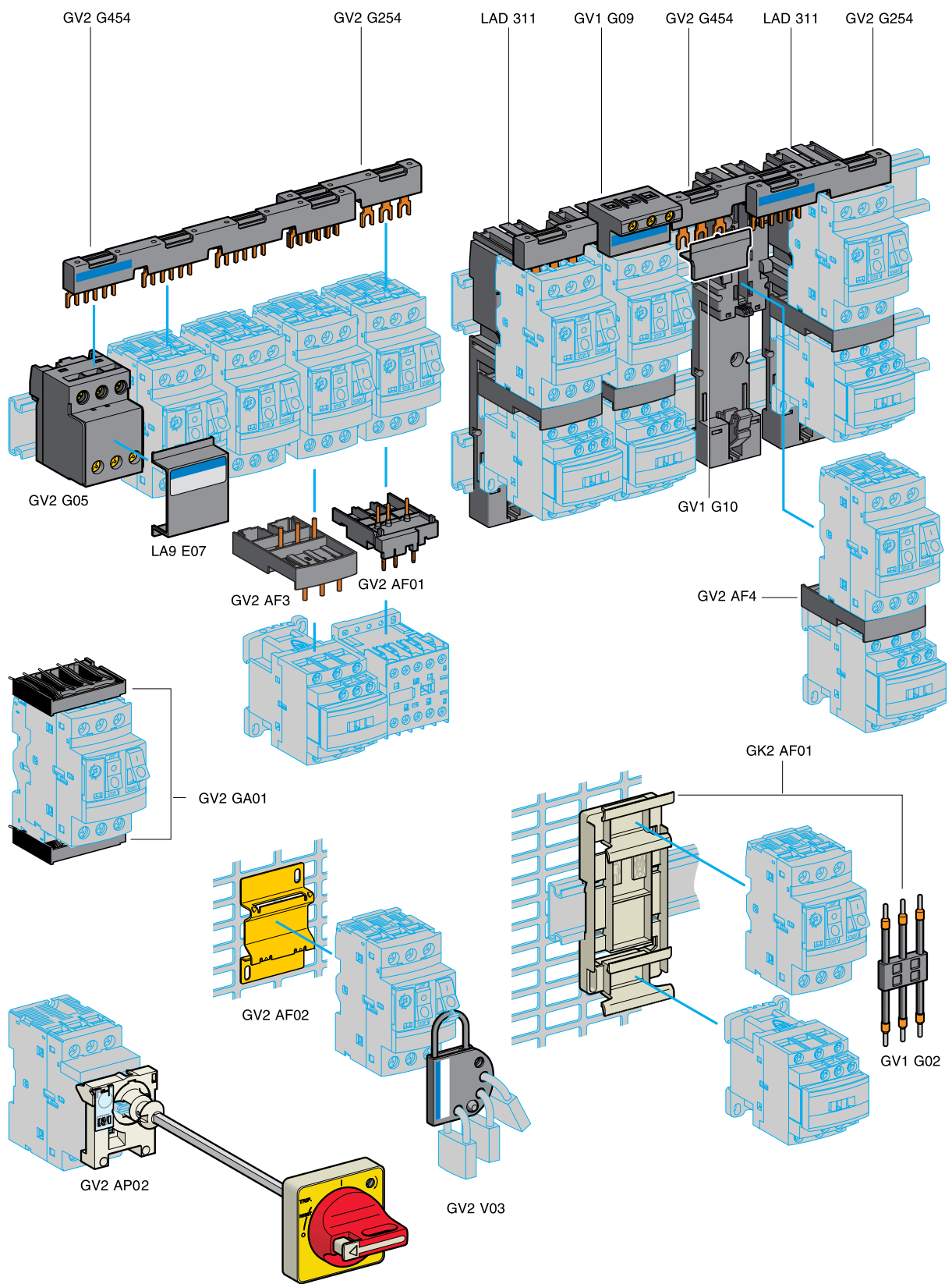



# TeSys protection components

## Thermal-magnetic and magnetic motor circuit-breakers GV2 with screw clamp connections

### Accessories

Accessories				
Description	Application	Sold in lots of	Unit reference	Weight kg
Adapter plates	For mounting a GV2 ME or GV2 LE by screw fixing	10	GV2 AF02	0.021
	For mounting a GV2 ME or GV2 P and contactor LC1 D09...D38 with front faces aligned	1	LAD 311	0.040
Height compensation plate	7,5 mm	10	GV1 F03	0.003
Combination blocks	Between GV2 and contactor LC1 K or LP1 K	10	GV2 AF01	0.020
	Between GV2 and contactor LC1 D09...D38	10	GV2 AF3	0.016
	Between GV2 mounted on LAD 311 and contactor LC1 D09...D38	10	GV2 AF4	0.016
Motor starter adapter plate	With 3-pole connection for mounting a GV2 and a contactor LC1 D09...D25	1	GK2 AF01	0.120

Description	Application	Pitch mm	Reference	Weight kg
Sets of 3-pole 63 A busbars	2 tap-offs	45	GV2 G245	0.036
		54	GV2 G254	0.038
		72	GV2 G272	0.042
	3 tap-offs	45	GV2 G345	0.058
		54	GV2 G354	0.060
	4 tap-offs	45	GV2 G445	0.077
		54	GV2 G454	0.085
		72	GV2 G472	0.094
	5 tap-offs	54	GV2 G554	0.100

Description	Application	Sold in lots of	Unit reference	Weight kg
Protective end cover	For unused busbar outlets	5	GV1 G10	0.005
Terminal block for supply to one or more GV2 G busbar sets	Connection from the top	1	GV1 G09	0.040
	Can be fitted with current limiter GV1 L3 (GV2 ME and GV2 P)	1	GV2 G05	0.115
Cover for terminal block	For mounting in modular panels	10	LA9 E07	0.005
Flexible 3-pole connection for connecting a GV2 to a contactor LC1-D09...D25	Centre distance between mounting rails: 100...120 mm	10	GV1 G02	0.013
Set of connections upstream/downstream	For connecting GV2 ME to a printed circuit board	10	GV2 GA01	0.045
"Large Spacing" adapter UL 508 type E	For GV2 P●●H7 (except 32 A)	1	GV2 GH7	0.040
Clip-in marker holders (supplied with each circuit-breaker)	For GV2 P, GV2 L, GV2 LE and GV2 RT (8 x 22 mm)	100	LA9 D92	0.001

Padlockable external operators				
Description		Reference	Weight kg	
For GV2 P and GV2 L (150 to 290 mm)	Padlocking in "On" and "Off" position Black handle, blue legend plate, IP 54	GV2 AP01	0.200	
	Padlocking in "Off" position Red handle, yellow legend plate, IP 54	GV2 AP02	0.200	
For GV2 LE	Padlocking in "On" and "Off" position Black handle, blue legend plate, IP 54	GV2 AP03	0.280	

Padlocking device				
Description		Reference	Weight kg	
For all GV2 device	For use with up to 4 padlocks, Ø 6 mm shank max. (padlocks not included)	GV2 V03	0.092	

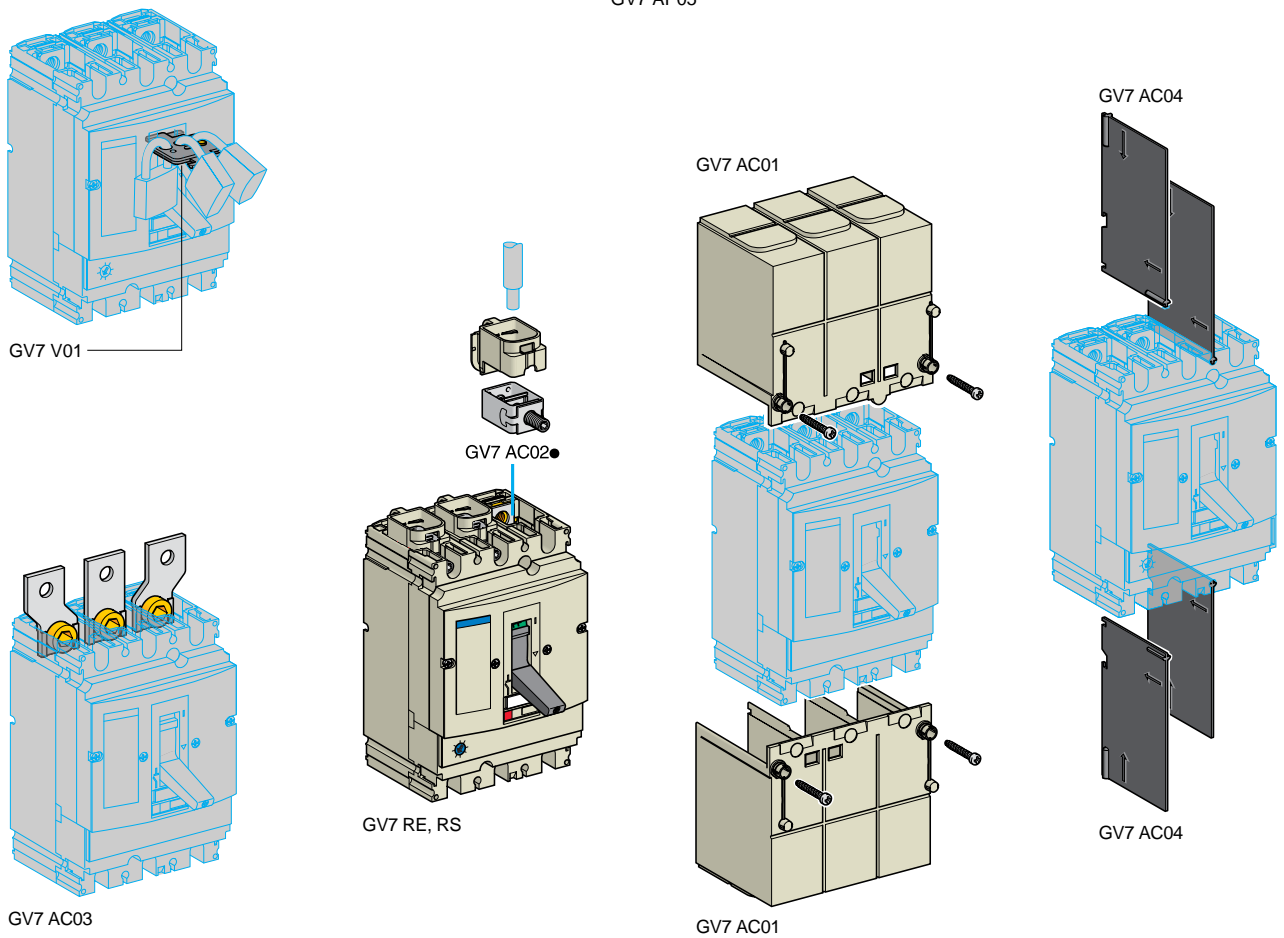
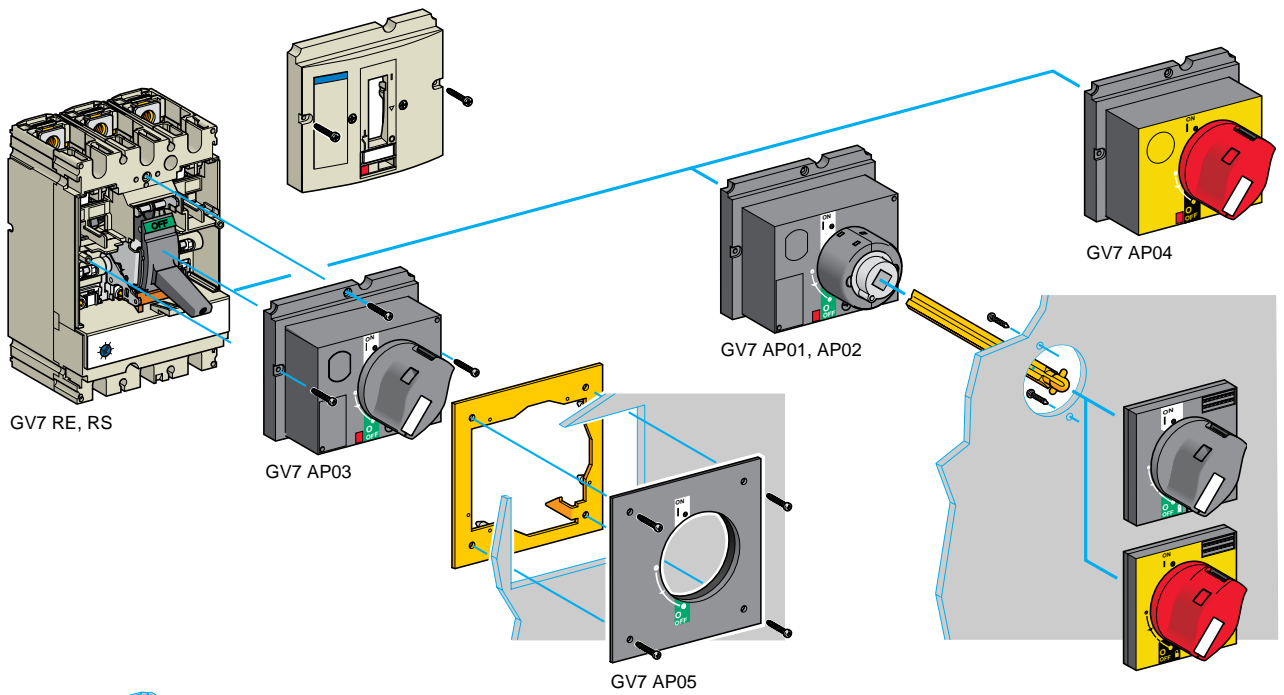

# TeSys protection components

## Thermal-magnetic motor circuit-breakers

### GV7 R with screw clamp connections

#### Accessories

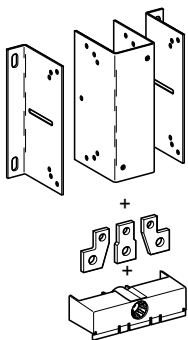

GV7 AC07

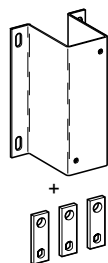

GV7 AC08

### Cabling accessories

Description	Application	For use on contactors	Sold in lots of	Unit reference	Weight kg
Clip-on connectors for GV7 R	Up to 150 A, 1.5...95 mm <sup>2</sup>	–	3	GV7 AC021	0.300
	Up to 220 A, 1.5...185 mm <sup>2</sup>	–	3	GV7 AC022	0.350
Spreader 3-pole (1)	To increase the pitch to 45 mm	–	1	GV7 AC03	0.180
Terminal shields IP 405 (1)	Supplied with sealing accessory	–	1	GV7 AC01	0.125
Phase barriers	Safety accessories used when fitting of shields is impossible	–	2	GV7 AC04	0.075
Insulating screens	Ensure insulation between the connections and the backplate	–	2	GV7 AC05	0.075
Kits for combination with contactor(2)	Allowing link between the circuit-breaker and the contactor. The cover provides protection against direct finger contact	LC1 F115...F185	1	GV7 AC06	0.550
		LC1 F225 and F265	1	GV7 AC07	0.550
		LC1 D115 and D150	1	GV7 AC08	0.550

### Direct rotary handle

Replaces the circuit-breaker front cover; secured by screws. It includes a device for locking the circuit-breaker in the O (Off) position by means of up to 3 padlocks with a shank diameter of 5 to 8 mm (padlocks not included). A conversion accessory allows the direct rotary handle to be mounted on the enclosure door. In this case, the door cannot be opened if the circuit-breaker is in the "ON" position. Circuit-breaker closing is inhibited if the enclosure door is open.

Description	Type	Degree of protection	Reference	Weight kg
Direct rotary handle	Black handle, black legend plate	IP 40	GV7 AP03	0.205
	Red handle, yellow legend plate	IP 40	GV7 AP04	0.205
Adapter plate (3)	Four mounting direct rotary handle on enclosure door	IP 43	GV7 AP05	0.100

### Extended rotary handle

Allows a circuit-breaker installed in the back of an enclosure to be operated from the front of the enclosure. It comprises:

- a unit which screws onto the front cover of the circuit-breaker,
- an assembly (handle and front plate) to be fitted on the enclosure door,
- an extension shaft which must be adjusted (distance between the mounting surface and the door: 185 mm minimum, 600 mm maximum). It includes a device for locking the circuit-breaker in the O (Off) position by means of up to 3 padlocks with a shank diameter of 5 to 8 mm (padlocks not included). This prevents the enclosure door from being opened.

Description	Type	Degree of protection	Reference	Weight kg
Extended rotary handle	Black handle, black legend plate	IP 55	GV7 AP01	0.775
	Red handle, yellow legend plate	IP 55	GV7 AP02	0.775

### Locking device

Allows circuit-breakers not fitted with a rotary handle to be locked in the O (Off) position by means of up to 3 padlocks with a shank diameter of 5 to 8 mm (padlocks not included).

Description	Application	Reference	Weight kg
Locking device	For circuit-breaker not fitted with a rotary handle	GV7 V01	0.100

(1) Terminal shields cannot be used together with spreaders.

(2) The kit comprises links, a protective shield and a depth adjustable metal bracket for the breaker.

(3) This conversion accessory makes it impossible to open the door if the device is closed and prevents the device from being closed if the door is open.

#### Dimensions

##### GV2 ME

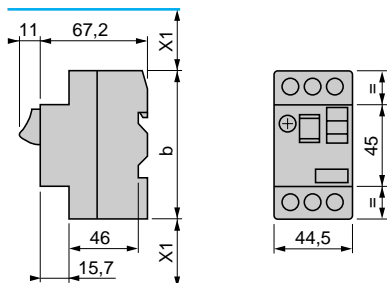

	b
GV2 ME●●	89
GV2 ME●●3	101

(1) Maximum

X1 Electrical clearance = 40 mm for  $U_e \leq 690$  V

##### GV2 P

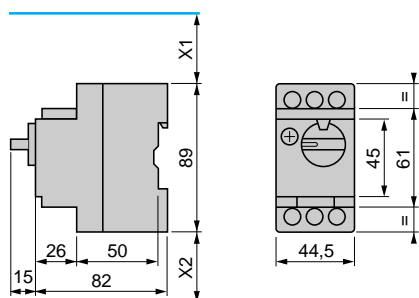

(1) Maximum

X1 Electrical clearance = 40 mm for  $U_e \leq 415$  V, or 80 mm for  $U_e = 440$  V, or 120 mm for  $U_e = 500$  and 690 V

X2 = 40 mm

##### GV AX

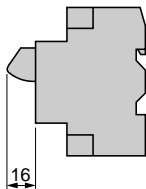

##### GV AD, AM, AN, AU, AS, AX

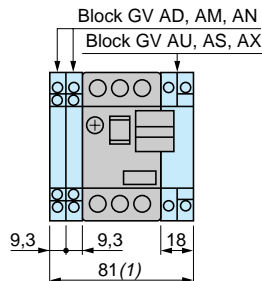

##### GV AE

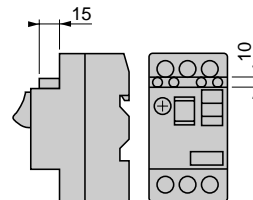

##### GV AD, AM, AN, AU, AS

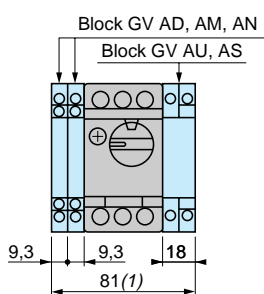

##### GV2 AK00

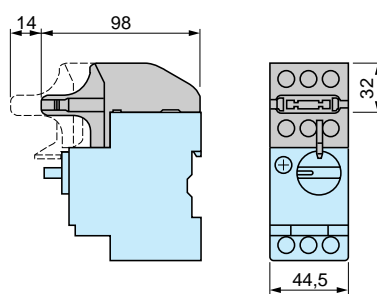

#### Mounting

##### GV2 ME

On 35 mm  $\sqsubset$  rail

On panel with adapter plate GV2 AF02

On pre-slotted plate AM1 PA

On rails DZ5 MB201

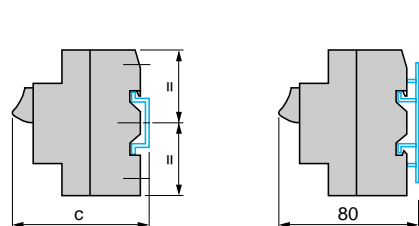

$c = 78,5$  on AM1 DP200 (35 x 7,5)  
 $c = 86$  on AM1 DE200, ED200 (35 x 15)

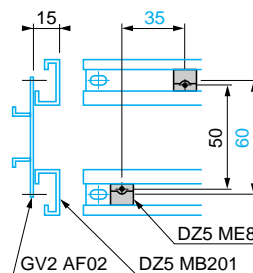
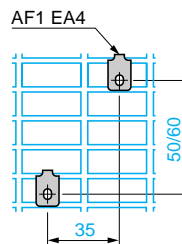
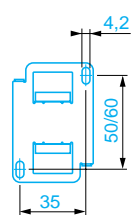

##### GV2 P

On rail AM1 DE200, ED200 (35 x 15)

Panel mounted

On pre-slotted plate AM1 PA

Adapter plate GK2 AF01

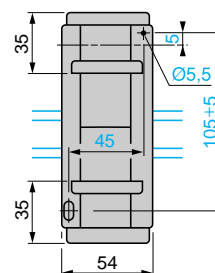
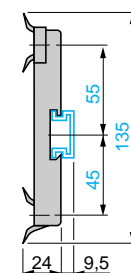
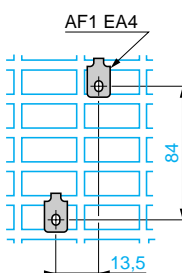
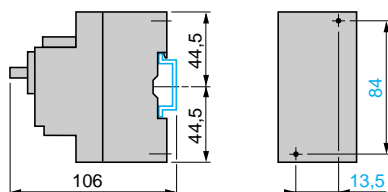

#### Dimensions

##### GV2 AF01

Combination GV2 ME + k contactor

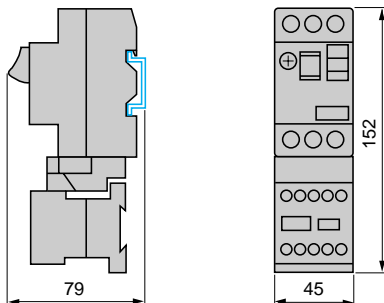

##### GV2 AF3

Combination GV2 ME + d contactor

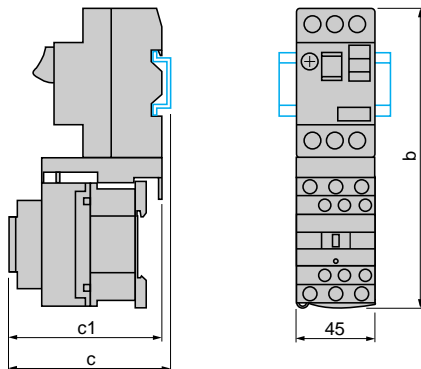

Combination GV2 P + d contactor

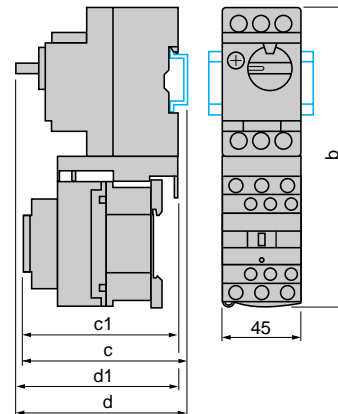

GV2 ME +	LC1 D09...D18	LC1 D25 & D32
b	1764	1868
c1	941	1004
c	996	1059

GV2 P +	LC1 D09...D18	LC1 D25 & D32
b	1764	1868
c1	1001	1064
c	1056	1119
d1	95	95
d	1005	1005

##### GV2 AF4 + LAD 311

Combination GV2 ME + d contactor

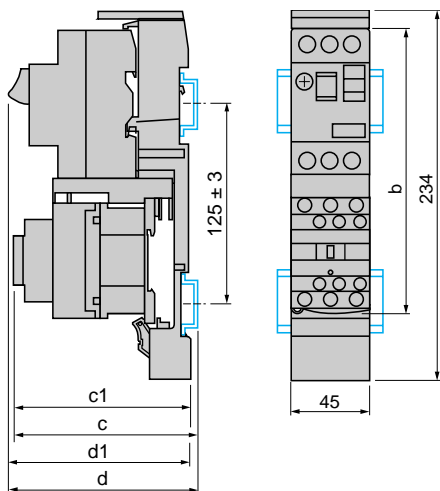

Combination GV2 P + d contactor

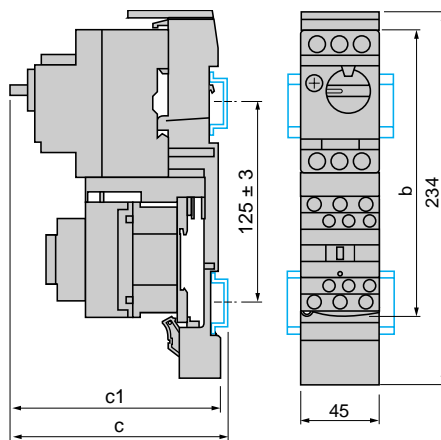

##### GV2 ME + GV1 L3 (current limiter)

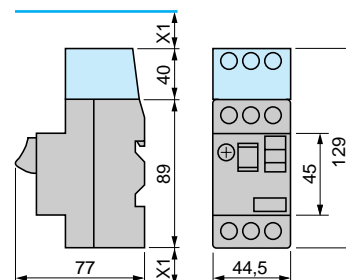

X1 = 10 mm for Ue = 230 V  
or 30 mm for 230 V < Ue ≤ 690 V

##### 7.5 mm height compensation plate GV1 F03



GV2 ME +	LC1 D09...D18	LC1 D25 & D32
b	1764	1868
c1	1031	1364
c	1356	1419
d1	107	107
d	1125	1125

GV2 P +	LC1 D09...D18	LC1 D25 & D32
b	1764	1868
c1	1365	1424
c	1416	1479

#### Mounting

Mounting of external operator GV2 AP01 or GV2 AP02 for motor circuit-breakers GV2 P

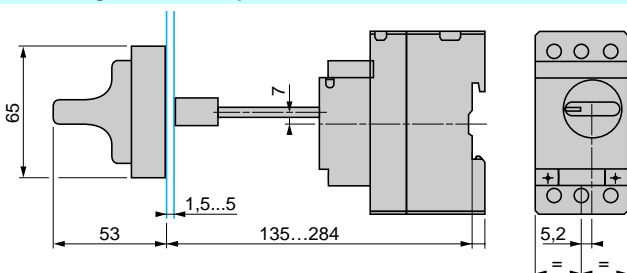

Door cut-out

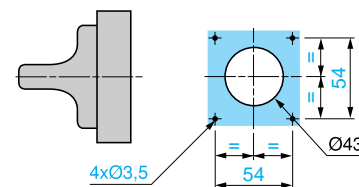

#### GV2 ME, GV2 P

Sets of busbars GV2 G445, GV2 G454, GV2 G472, with terminal block GV2 G05

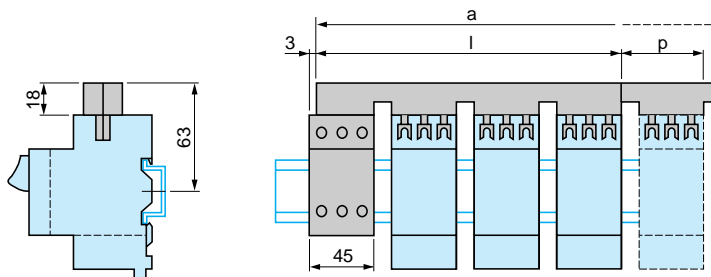

	l	p
GV2 G445 (4 x 45 mm)	179	45
GV2 G454 (4 x 54 mm)	206	54
GV2 G472 (4 x 72 mm)	260	72

	a			
Number of tap-offs	5	6	7	8
GV2 G445	224	269	314	359
GV2 G454	260	314	368	422
GV2 G472	332	404	476	548

#### Sets of busbars GV2 G●●● with terminal block GV1 G09

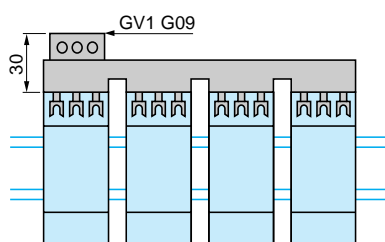

#### Sets of busbars GV2 G245, GV2 G254, GV2 G272

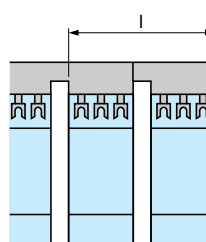

	l
GV2 G245 (2 x 45 mm)	89
GV2 G254 (2 x 54 mm)	98
GV2 G272 (2 x 72 mm)	116

#### Sets of busbars GV2 G554

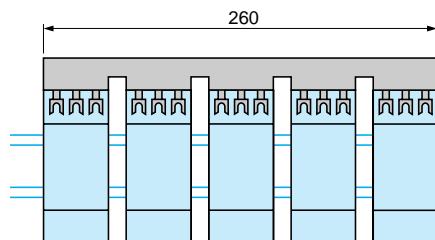

#### Sets of busbars GV2 G345 and GV2 G354

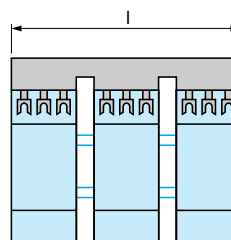

	l
GV2 G345 (3 x 45 mm)	134
GV2 G354 (3 x 54 mm)	152

**Note:** To avoid overheating, leave a gap of 10 mm between circuit-breakers when installing.

#### GV2 RT

##### Dimensions

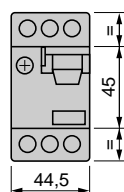
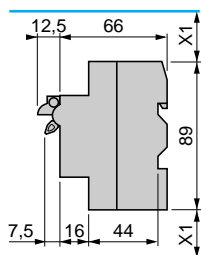

##### Mounting of external operator GV2 AP03

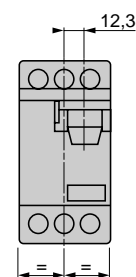
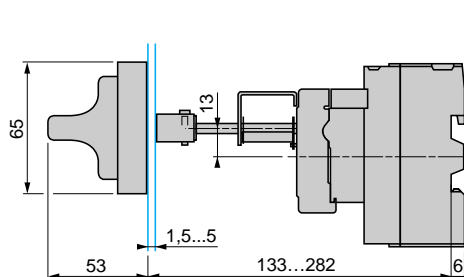

X1: Electrical clearance = 40 mm for  $U_e < 690$  V

##### Mounting

On 35 mm mounting rail

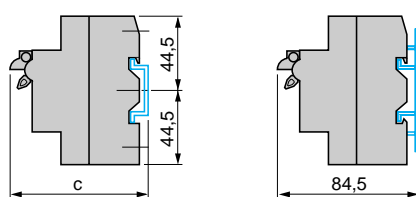

c = 80 on AM1 DP200 (35 x 7,5)  
c = 88 on AM1 DE200, ED200 (35 x 15)

On panel with adapter plate GV2 AF02

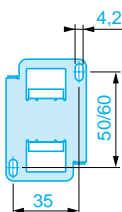

On pre-slotted plate AM1 PA

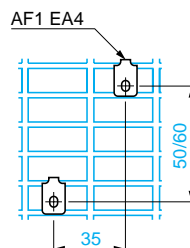

On rails DZ5 MB

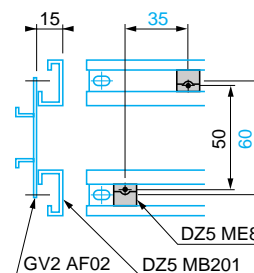

#### GV3 P

##### Dimensions

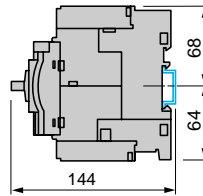
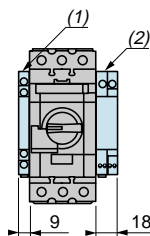
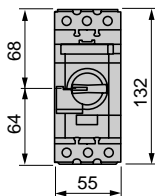
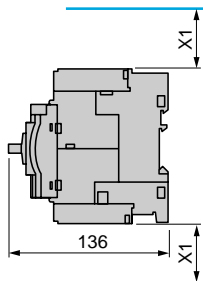

##### Mounting on rail AM1 DE200 or AM1 ED201

X1 = Electrical clearance (ISC max)  
40 mm for Ue < 500 V, 50 mm for Ue < 690 V

(1) Blocks GV AN●●, GV AD●●, GV AM11  
(2) Block GV3 AU●● and GV3 AS●●

##### Mounting on panel, using M4 screws

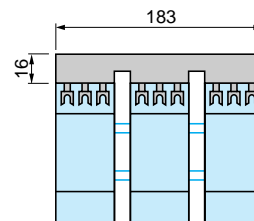
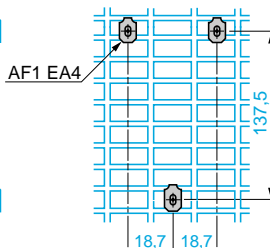
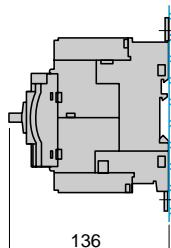
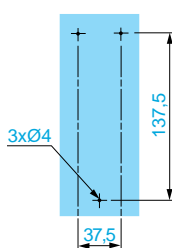
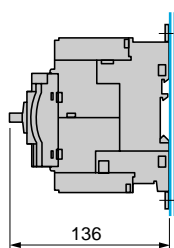

**Note:** Leave a space of 9 mm between 2 circuit-breakers: either an empty space or side-mounting add-on contact blocks.  
Horizontal mounting is possible up to 40 °C.

##### Mounting on pre-slotted mounting plate AM1 PA

#### GV7 R

##### Dimensions

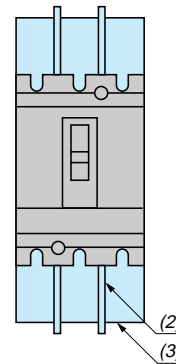
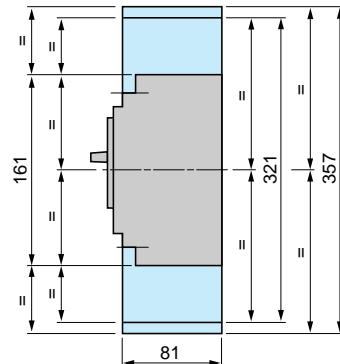
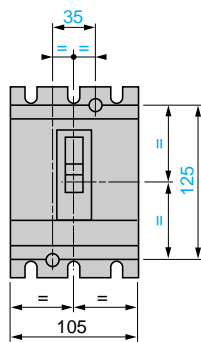
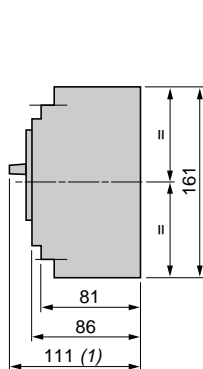

##### Motor circuit-breakers with terminal shields or phase barriers GV7 R + GV7 AC01 or AC04

(1) 126 for GV7 R●220

(2) Phase barriers: GV7 AC04

(3) Terminal shields: GV7 AC01

##### Combination of GV7 R and LC1 F with kit GV7 AC0●

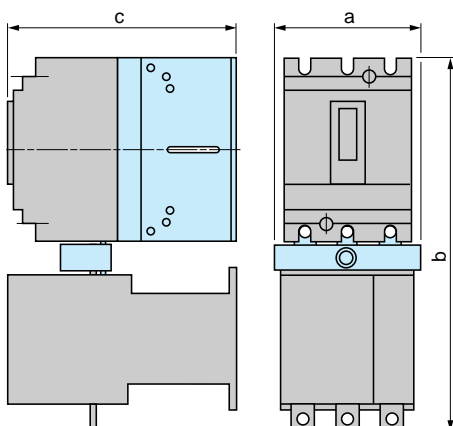

	a	b	c
GV7 R + LC1 F115 or F150 + GV7 AC06	119	334	181
GV7 R + LC1 F185 + GV7 AC06	119	338	188
GV7 R + LC1 F225 + GV7 AC07	131	358	188
GV7 R + LC1 F265 + GV7 AC07	131	364	215

Minimum distance between 2 circuit-breakers mounted side-by-side = 0

##### Minimum electrical clearance

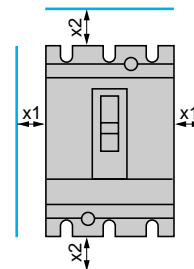

	x1	x2
Painted or insulated metal plate, insulation or insulated bar	0	30
Bare metal plate	U ≤ 440 V	5
	440 V < U < 600 V	10
	U ≥ 600 V	20

## GV7 R

Panel mounting

Mounting on 2 mounting rails DZ5 MB201

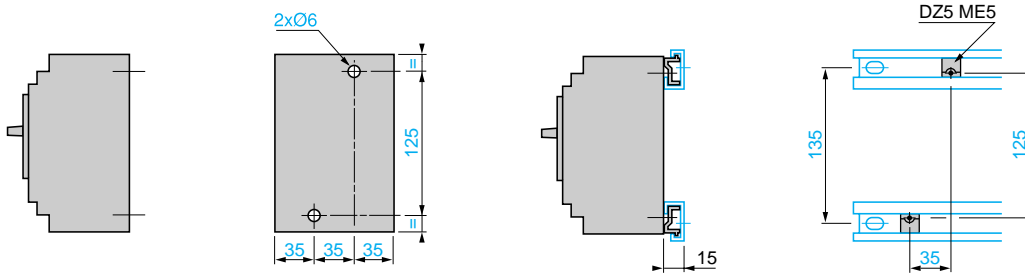

## Flush-mounting

1 circuit-breaker GV7 R

n circuit-breakers GV7 R  
side-by-side

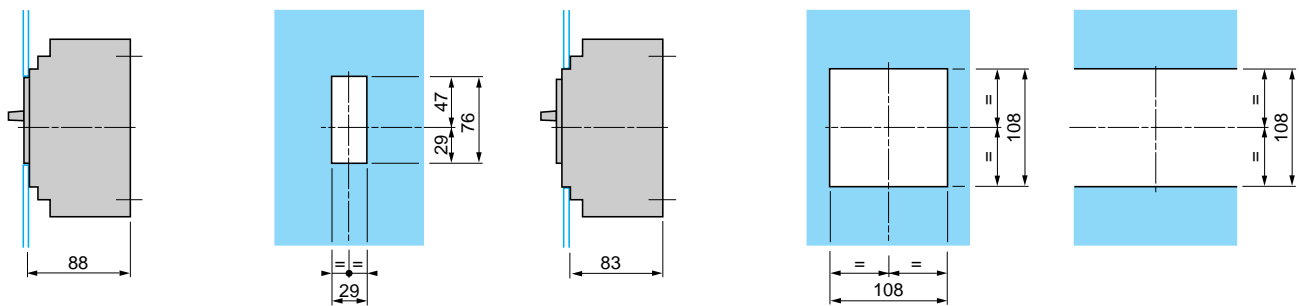

## Combination of GV7 R and LC1 F with kit GV7 AC0●

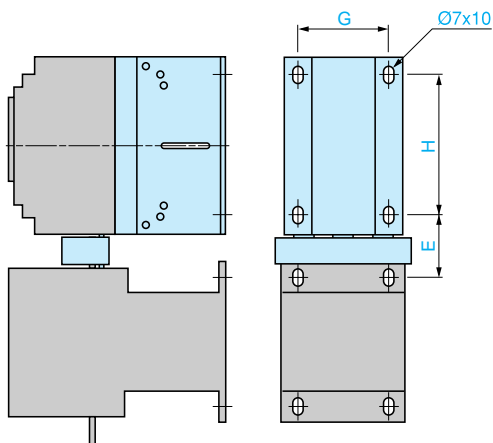

	E	G	H
GV7 R + LC1 F115 + GV7 AC06	44	85	120
GV7 R + LC1 F150 + GV7 AC06	46	85	120
GV7 R + LC1 F185 + GV7 AC06	48	85	120
GV7 R + LC1 F225 + GV7 AC07	57	85	120
GV7 R + LC1 F265 + GV7 AC07	60	85	120



#### Spreaders GV7 AC03

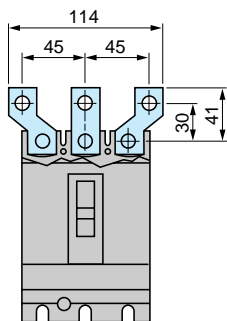

#### Connection

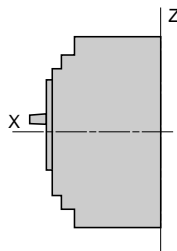

#### Smooth terminals

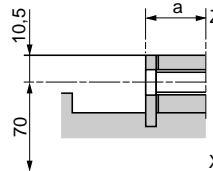

#### Connectors

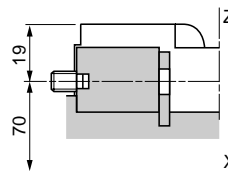

	a
GV7 R $\bullet$ 40...R $\bullet$ 150	19.5
GV7 R $\bullet$ 220	21.5

#### Direct rotary handle GV7 AP03, GV7 AP04

#### Flush-mounting

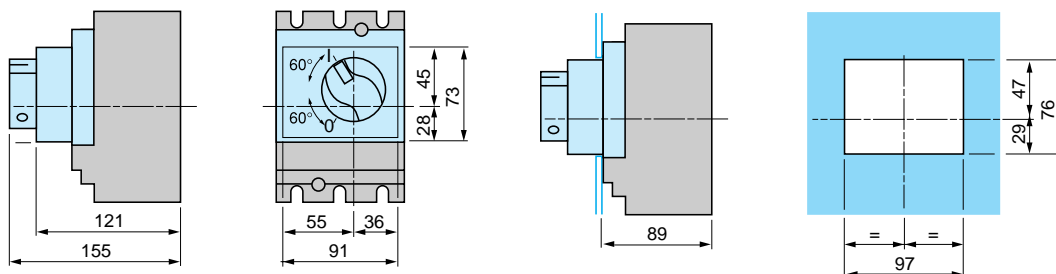

#### Direct rotary handle GV7 AP03 or GV7 AP04 with conversion accessory GV7 AP05

#### Front face cut-out

#### Enclosure viewed from top

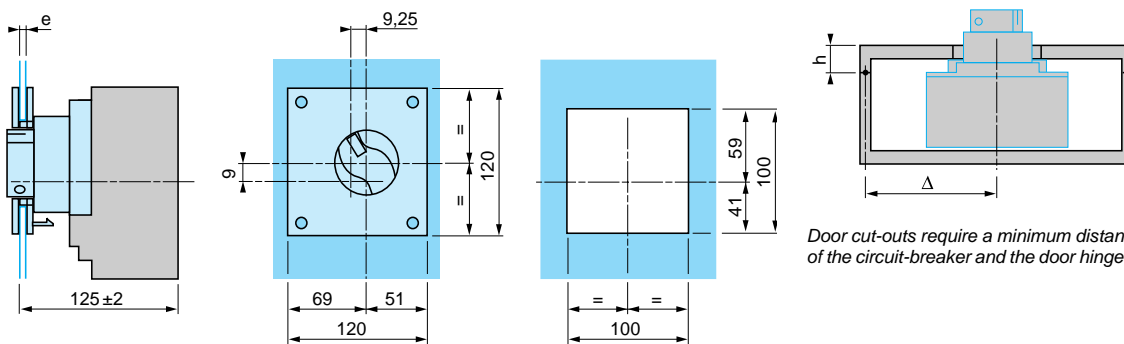

Door cut-outs require a minimum distance between the centre of the circuit-breaker and the door hinge point  $\Delta \geq 100 + (h \times 5)$ .

$e = 1$  to  $3$  max

#### Extended rotary handle GV7 AP01, GV7 AP02

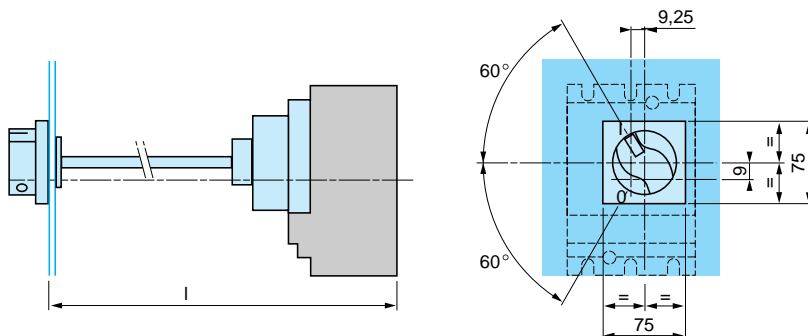

$l$ : 185 min, 600 max

The shaft of the extended rotary handle GV7 AP01 or GV7 AP02 must be cut to length:  $l - 126$  mm.

### Schemes

#### GV2 ME●● and GV2 RT

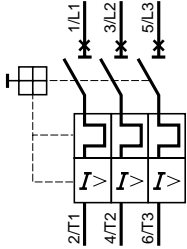

#### GV2 P●●

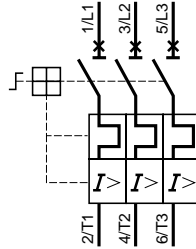

#### GV3 P●●

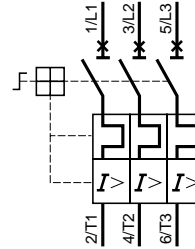

#### Front mounting add-on contact blocks Instantaneous auxiliary contacts

##### GV AE1

##### GV AE11

##### GV AE20

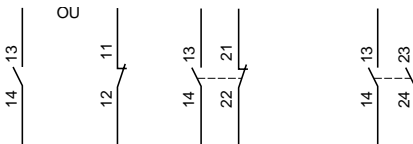

#### Front mounting add-on contact blocks Instantaneous auxiliary contacts and fault signalling contacts

##### GV AED101

##### GV AED011



#### Side mounting add-on contact blocks Instantaneous auxiliary contacts and fault signalling contacts

##### GV AD0110

##### GV AD0101

##### GV AD1010

##### GV AD1001



#### Instantaneous auxiliary contacts

##### GV AN11

##### GV AN20



#### Short-circuit signalling contacts

##### GV AM11

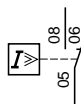

#### Voltage trips

##### GV AU●●●

##### GV AS●●●

##### GV AX●●●

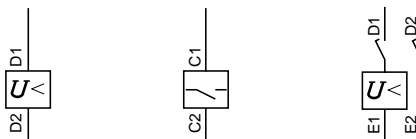

#### Current limiter

##### GV1 L3

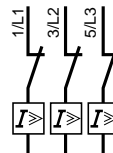

#### Use of fault signalling contact and short-circuit signalling contact

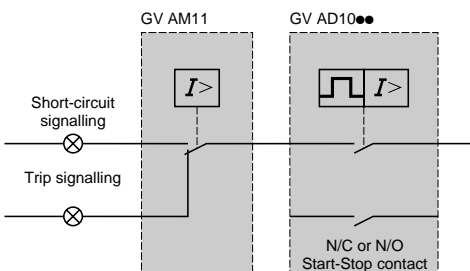

#### Connection of undervoltage trip for dangerous machines (conforming to INRS) on GV2 ME only

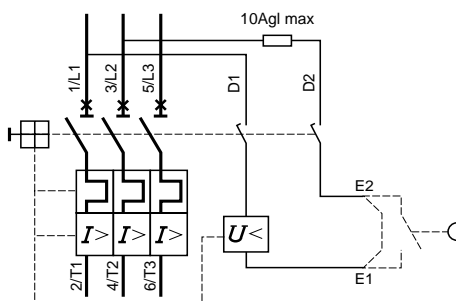

#### Motor circuit-breakers

##### GV3 ME

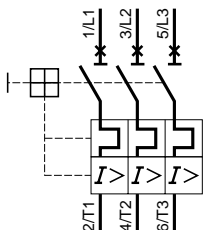

#### Auxiliary contact block modules

##### GV3 A01



##### GV3 A02



##### GV3 A03

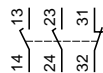

##### GV3 A05

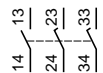

##### GV3 A06

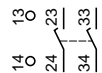

##### GV3 A07

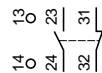

#### Fault signalling contacts

##### GV3 A08



##### GV3 A09



#### Voltage trips

##### GV3 B



##### GV3 D



#### Motor circuit-breakers

##### GV7 R

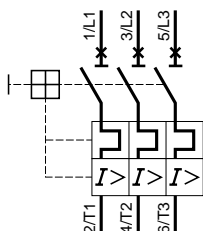

#### Add-on auxiliary contacts according to their location (1)

##### GV7 AE11, GV7 AB11

##### Location 1 C/O contact



##### Location 2 Trip indication



##### Location 3 Electrical fault indication



##### Location 4 C/O contact



A self-adhesive label, supplied with the contact, can be affixed to the front face of the circuit-breaker to allow personalised marking according to the function of the contact or contacts.  
(1) See pages 24513/4 and 24512/7.

#### Electric trips

##### GV7 AU●●●

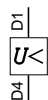

##### GV7 AS●●●



##### GV7 AD111, AD112

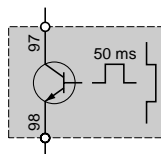

#### Recommended application schemes GV7 AD111, AD112

##### Fault indication

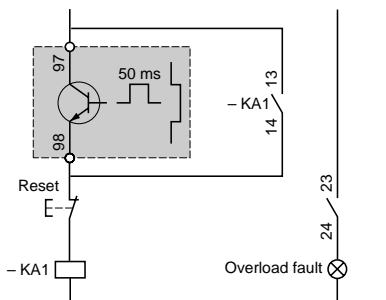

##### Contactor opening on overload

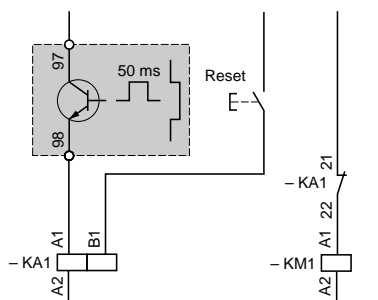

Associated components  
KA1: CA2 KN or CAD N

Associated components  
KA1: CAD + LAD 6K10 or RHK  
KM1: LC1 D or LC1 F

#### GV2 L

##### Dimensions

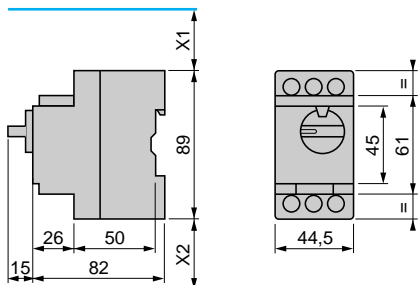

X1 Electrical clearance = 40 mm for  $U_e \leq 415$  V, or 80 mm for  $U_e = 440$  V, or 120 mm for  $U_e = 500$  and 690 V.  
X2 = 40 mm.

##### GV AD, AM, AN, AU, AS

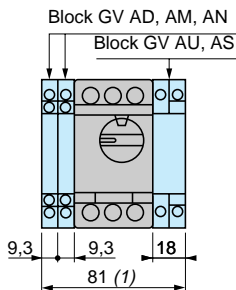

(1) Maximum

##### GV2 AK00

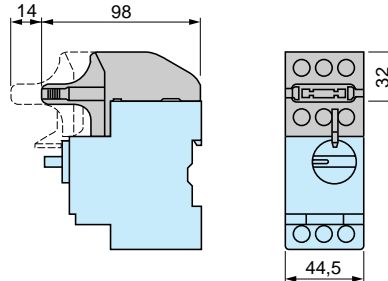

##### Mounting

On rail AM1 DE200, AM1 ED200 (35 x 15)

Panel mounted

On pre-slotted mounting plate AM1 PA

##### Adapter plate GK2 AF01

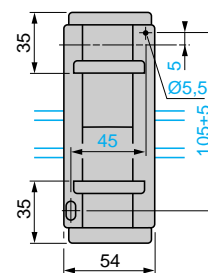
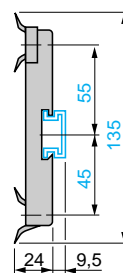
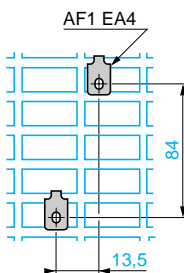
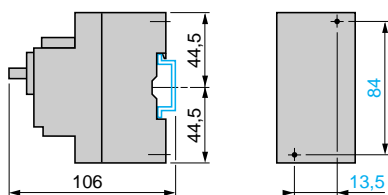

##### 7.5 mm height compensation plate GV1 F03



#### GV2 LE

##### Dimensions

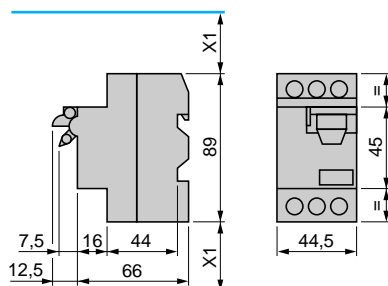

X1 Electrical clearance = 40 mm for  $U_e \leq 690$  V.

##### GV AD, AM, AN, AU, AS

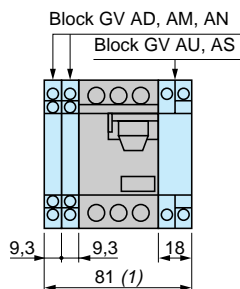

(1) Maximum

##### GV AE

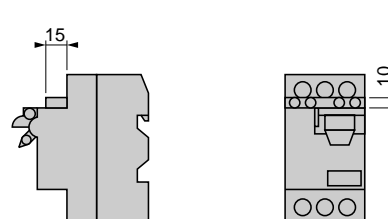

##### Mounting

On 35 mm rail

On panel with adapter plate GV2 AF02

On pre-slotted plate AM1 PA

On rails DZ5 MB201

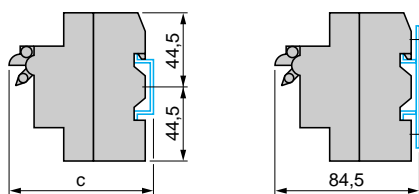

c = 80 on AM1 DP200 (35 x 7.5) and 88 on AM1 DE200, ED200 (35 x 15)

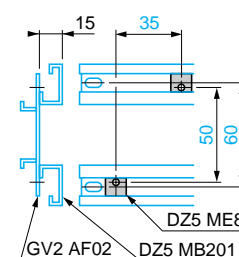
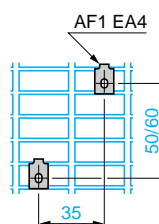
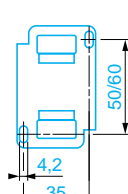

Mounting of external operator GV2 AP01 or GV2 AP02 for GV2 L

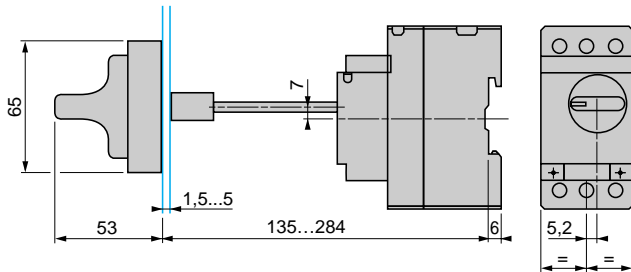

Mounting of external operator GV2 AP03 for GV2 LE

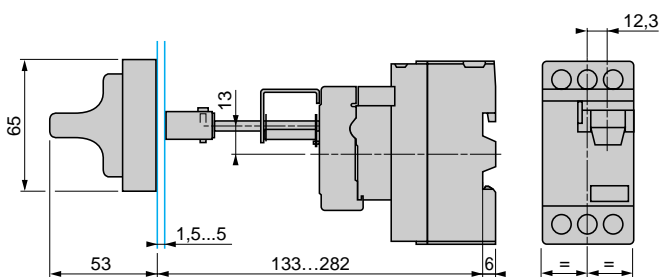

Door cut-out

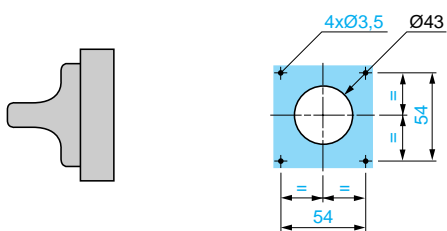

Sets of busbars GV2 G445, GV2 G454, GV2 G472, with terminal block GV2 G05

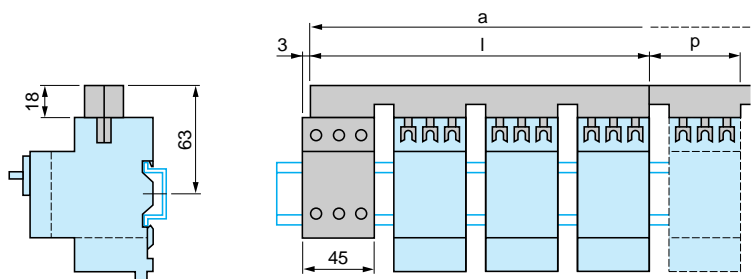

	l	p
GV2 G445 (4 x 45 mm)	179	45
GV2 G454 (4 x 54 mm)	206	54
GV2 G472 (4 x 72 mm)	260	72

Number of tap-offs	a			
	5	6	7	8
GV2 G445	224	269	314	359
GV2 G454	260	314	368	422
GV2 G472	332	404	476	548

### Sets of busbars for GV2

Sets of busbars GV2 G●●● with term. block GV1 G09

Sets of busbars GV2 G245, GV2 G254, GV2 GR272

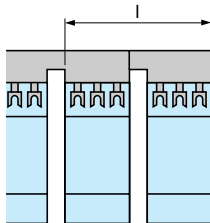
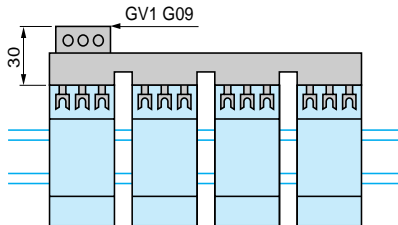

	l
GV2 G245 (2 x 45 mm)	89
GV2 G254 (2 x 54 mm)	98
GV2 G272 (2 x 72 mm)	116

Set of busbars GV2 G554

Sets of busbars GV2 G345 and GV2 G354

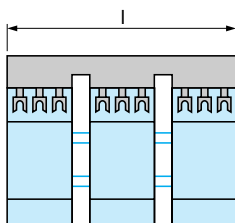
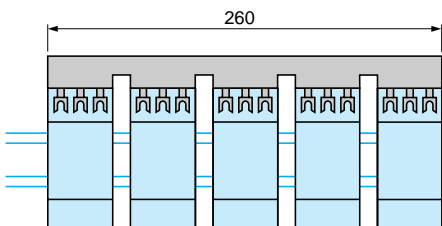

	l
GV2 G345 (3 x 45 mm)	134
GV2 G354 (3 x 54 mm)	152

### GV3 L

Dimensions

Mounting on rail AM1 DE200 or AM1 ED201

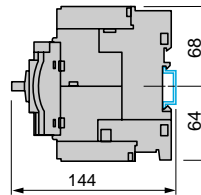
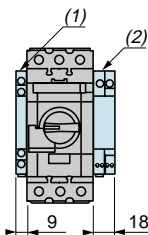
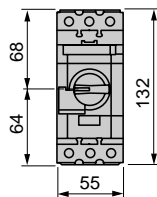
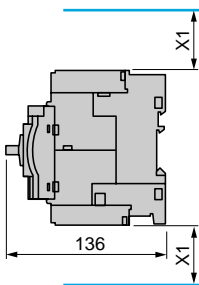

X1 = Electrical clearance (ISC max)  
40 mm for Ue < 500 V, 50 mm for Ue < 690 V

(1) Blocks GV AN●●, GV AD●● and GV AM11  
(2) Blocks GV3 AU●● and GV3 AS●●

Panel mounting, using M4 screws

Mounting on pre-slotted plate AM1 PA

Set of busbars  
GV3 G364

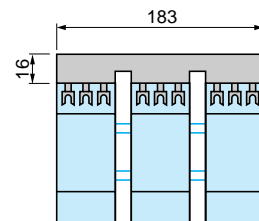
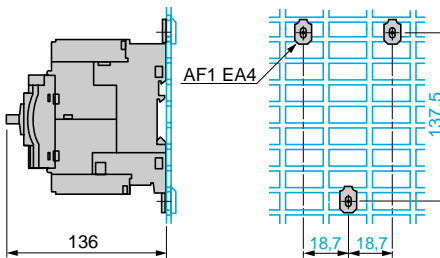
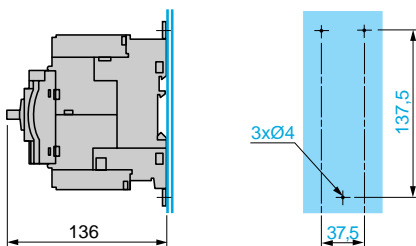

Note: Leave a space of 9 mm between 2 circuit-breakers: either an empty space or side-mounting add-on contact blocks.  
Horizontal mounting is possible up to 40 °C.

Set of busbars GV2 G554

Set of busbars GV2 G345 and GV2 G354

GK3 EF80 + 4 GK2 AX

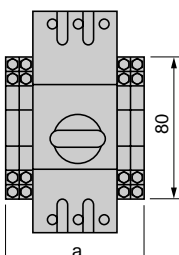

	Number of GK2 AX				
	0	1	2	3	4
a	66	74.8	83.5	92.5	101

#### Magnetic motor circuit-breakers

GV2 L●●

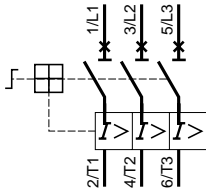

GV2 LE●●

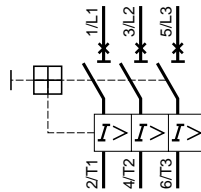

GV3 L●●

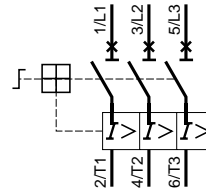

#### Accessories

##### Front mounting add-on contact blocks

##### Instantaneous auxiliary contacts

GV AE1

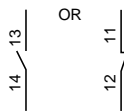

GV AE11

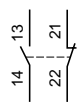

GV AE20

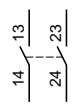

GV AED101 and GV AED011

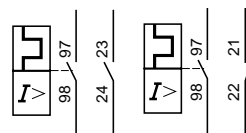

##### Side mounting add-on contact blocks

##### Instantaneous auxiliary contacts and fault signalling contacts

GV AD0110

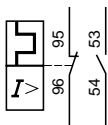

GV AD0101

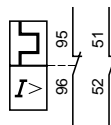

GV AD1010

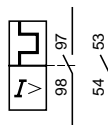

GV AD1001

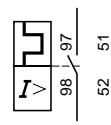

##### Instantaneous auxiliary contacts

GV AN11

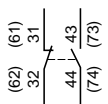

GV AN20

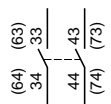

##### Short-circuit signalling contacts

GV AM11

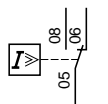

##### Voltage trips

GV AU●●●

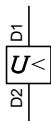

GV AS●●●



##### Start-Stop signalling contact blocks

GK2 AX10



GK2 AX20

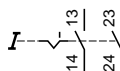

GK2 AX50

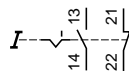

##### Fault signalling contact blocks

GK2 AX12



GK2 AX22

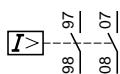

GK2 AX52

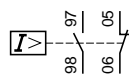

# TeSys enclosed starters

Enclosed thermal-magnetic motor circuit-breakers  
GV2 ME and accessories, for customer assembly

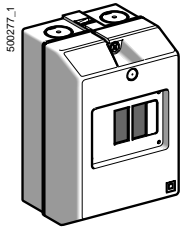

GV2 MC

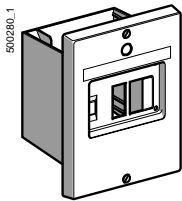

GV2 MP

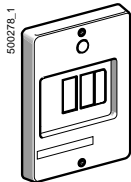

GV2 CP21

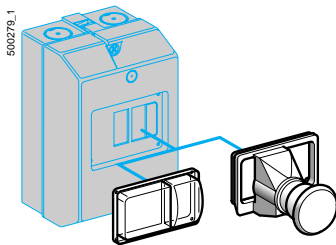

GV2 K011

## References

### Thermal-magnetic motor circuit-breakers GV2 ME

For motor circuit-breakers and accessories: see pages 24508/3, 24512/3 and 24512/11.

Starters consisting of a GV2 ME motor circuit-breaker in an enclosure conform to standard IEC 60947-4-1.

GV2	ME 01	ME 02	ME 03	ME 04	ME 05	ME 06	ME 07	ME 08	ME 10	ME 14	ME 16	ME 20	ME 21	ME 22
lthe in enclosure (A)	0.16	0.25	0.4	0.63	1	1.6	2.5	4	6.3	9	13	17	21	23

### Enclosures for thermal-magnetic circuit-breakers GV2 ME

Type	Degree of protection	Possible no. of side mounting auxiliary contact blocks on GV2 ME		Reference	Weight kg
		LH side	RH side		
Surface mounting, double insulated with protective conductor. Sealable cover	IP 41	1	1	GV2 MC01	0.290
	IP 55	1	1	GV2 MC02	0.300
				or GV2 MCK04 (1)	0.420
	IP 55 for temperature < + 5 °C	1	1	GV2 MC03	0.300
Flush mounting, with protective conductor	IP 41 (front face)	1	1	GV2 MP01	0.115
	IP 41 (reduced flush mounting)	–	1	GV2 MP03	0.115
	IP 55 (front face)	1	1	GV2 MP02	0.130
	IP 55 (reduced flush mounting)	–	1	GV2 MP04	0.130

### Front plate

Description		Reference	Weight kg
For direct control, through a panel, of a chassis mounted GV2 ME	IP 55	GV2 CP21	0.800

### Accessories common to all enclosures (to be ordered separately)

Description		Sold in lots of	Unit reference	Weight kg	
Padlocking device (2) for GV2 ME operator (padlocking is only possible in the "O" position)	1 to 3 padlocks Ø 4 to 8 mm	1	GV2 V01	0.075	
Mushroom head	Spring return (2)	1	GV2 K011	0.052	
Emergency stop pushbutton Ø 40 mm, red	Latching (2)	Key release, key n° 455	1	GV2 K021	0.160
		Turn to release	1	GV2 K031	0.115
			1	GV2 K04 (3)	0.120
Sealing kit	For enclosures and front plate	IP 55	10	GV2 E01	0.012
		IP 55 for $\theta < + 5$ °C	10	GV2 E02	0.012
Neutral terminal		100	AB1 VV635UBL	0.015	
Partition		50	AB1 AC6BL	0.003	

(1) Enclosure GV2 MCK04 is fitted with a GV2 K04 mushroom head Emergency stop pushbutton as standard.

(2) Supplied with IP 55 sealing kit. To be fitted with enclosure GV2 M01.

(3) Padlockable in "O" position using Ø 4 to 8 mm shank padlocks.



# TeSys enclosed starters

Enclosed thermal-magnetic motor circuit-breakers  
GV3 P (for customer assembly)

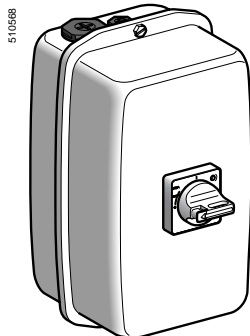

GV3 PC02

## References (continued)

### Thermal-magnetic motor circuit-breakers GV3 P

For motor circuit-breakers and accessories: see pages 24508/4 and 24512/5.

GV3 P40: operational current in enclosure limited to 30 A.

Starters consisting of a GV3 P motor circuit-breaker in an enclosure conform to standards IEC/EN 60947-4-1 and IEC/EN 60947-2.

### Metal enclosures fitted with a padlockable rotary handle (1), for thermal-magnetic circuit-breakers GV3 P, up to 30 A

Composition (2)	Type	Degree of protection of enclosure	Reference of enclosure	Weight kg
<ul style="list-style-type: none"> <li>■ Metal enclosure,</li> <li>■ Black handle GV2 AP01</li> <li>■ Padlocking in ON/OFF position</li> <li>■ Circuit-breaker/handle adapter</li> </ul>	Surface mounting	IP 65 IK 09	<b>GV3 PC01</b>	2.000
<ul style="list-style-type: none"> <li>■ Metal enclosure,</li> <li>■ Red handle GV2 AP02</li> <li>■ Padlocking in OFF position</li> <li>■ Circuit-breaker/handle adapter</li> </ul>	Surface mounting	IP 65 IK 09	<b>GV3 PC02</b>	2.000

(1) For special applications a **GV3 L** magnetic motor circuit-breaker can be fitted in this type of enclosure. Please consult your Regional Sales Office.

(2) Components for customer assembly. Circuit-breaker to be ordered separately.

## Dimensions

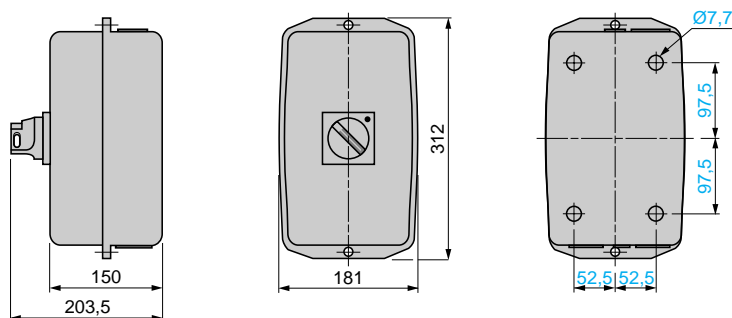

# TeSys enclosed starters

## Enclosed thermal-magnetic motor circuit-breakers GV2 ME and accessories Assembly of a safety enclosure

### Thermal-magnetic motor circuit-breakers GV2 ME

For motor circuit-breakers and accessories: see pages 24508/3, 24512/2 and 24512/3. Starters consisting of a GV2 ME motor circuit-breaker in an enclosure conform to standard IEC 60947-4-1.

GV2	ME 01	ME 02	ME 03	ME 04	ME 05	ME 06	ME 07	ME 08	ME 10	ME 14	ME 16	ME 20	ME 21	ME 22
the in enclosure (A)	0.16	0.25	0.4	0.63	1	1.6	2.5	4	6.3	9	13	17	21	23

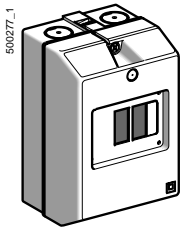

GV2 MC

### Enclosures for thermal-magnetic circuit-breakers GV2 ME

Type	Degree of protection	Possible number of side-mounting auxiliary contact blocks on GV2 ME		Reference	Weight kg
		LH side	RH side		
Surface mounting, double insulated with protective conductor. Sealable cover	IP 41	1	1	GV2 MC01	0.290
	IP 55	1	1	GV2 MC02	0.300
				or GV2 MCK04 (1)	0.420
IP 55 for temperature < + 5 °C	1	1	GV2 MC03	0.300	

### Accessories common to all enclosures (to be ordered separately)

Description		Sold in lots of	Unit reference	Weight kg	
<b>Padlocking devices (2)</b> for GV2 ME operator (padlocking is only possible in the "O" position)	1 to 3 padlocks Ø 4 to 8 mm	1	GV2 V01	0.075	
<b>Mushroom head</b>	Spring return (2)	1	GV2 K011	0.052	
<b>Emergency stop pushbutton Ø 40 mm, red</b>	Latching (2)	Key release, key n° 455	1	GV2 K021	0.160
	IP 55	Turn to release	1	GV2 K031	0.115
			1	GV2 K04 (3)	0.120
<b>Sealing kit</b> For enclosures and front plate	IP 55 for temperature between + 5 °C and + 40 °C	10	GV2 E01	0.012	
		10	GV2 E02	0.012	
<b>Neutral terminal</b>		100	AB1 VV635UBL	0.015	
<b>Partition</b>		50	AB1 AC6BL	0.003	

(1) Enclosure GV2 MCK04 is fitted with a GV2 K04 mushroom head Emergency stop pushbutton as standard.

(2) Supplied with IP 55 sealing kit. To be fitted with enclosure GV2 M001.

(3) Padlockable in "Off" position using Ø 4 to 8 mm shank padlocks.

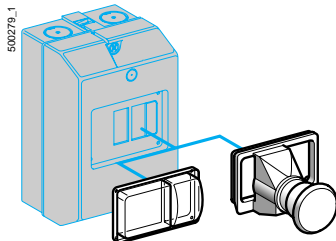

GV2 K011

**TeSys enclosed starters**

Enclosed thermal-magnetic motor circuit-breakers

GV2 ME and accessories

Assembly of a safety enclosure

**Assembly of a safety enclosure***(conforming to standards IEC 60974-4-1, IEC 60204 and IEC 60292)*

Type of product	Page	Reference
Enclosure	Opposite	GV2 MC●●
Circuit-breaker	24508/2	GV2 ME●●
Undervoltage trip or INRS trip (1)	24512/3	GV2 A●●●● or GV2 AX●●●
Latching mushroom head Stop pushbutton	Opposite	GV2 K021 or GV2 K031 or GV2 K04

*(1) Safety device for dangerous machines conforming to INRS and VDE 0113.*

## Dimensions

### Surface mounting enclosure GV2 MC0●

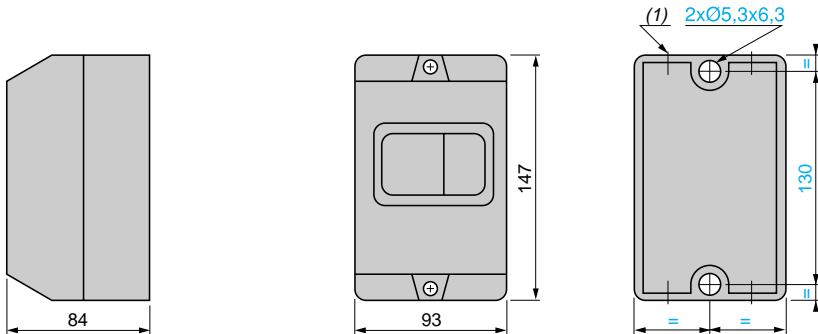

(1) 4 knock-outs for 16 mm plastic cable gland or 16 mm conduit.

### Surface mounting enclosure GV2 MCK04

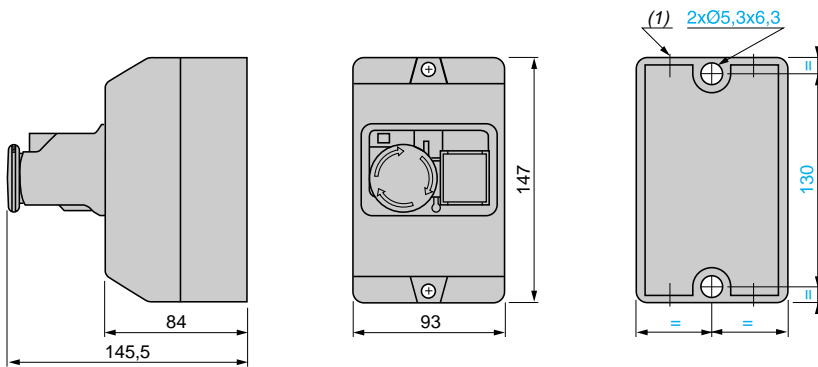

(1) 4 knock-outs for 16 mm plastic cable gland or 16 mm conduit.

## Mounting

### Flush mounting enclosures GV2 MP0● (panel cut-out)

#### GV2 MP0●

#### GV2 MP01, MP02

#### GV2 MP03, MP04

#### Front plate GV2 CP21

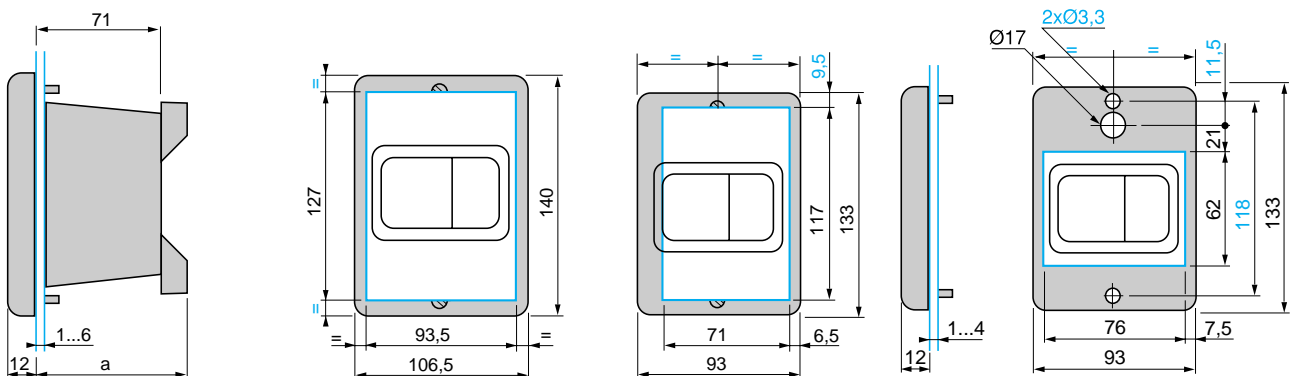

GV2	a
MP01, MP02	-
MP03, MP04	86

## Schemes

### GV2 ME●●

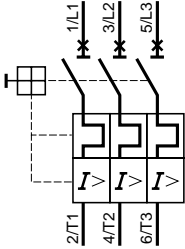

### Instantaneous auxiliary contacts

#### GV AE1

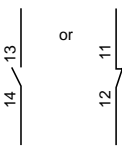

#### GV AE11

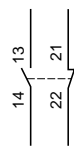

#### GV AE20

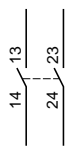

### Instantaneous auxiliary contacts and fault signalling contacts

#### GV AD0110

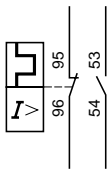

#### GV AD0101

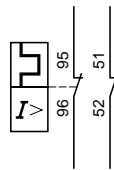

#### GV AD1010

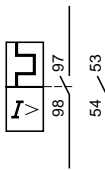

#### GV AD1001

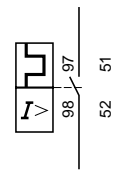

### Instantaneous auxiliary contacts

#### GV AN11

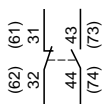

#### GV AN20

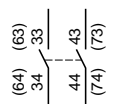

### Short-circuit signalling contacts

#### GV AM11

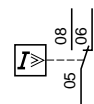

### Voltage trips

#### GV AU●●●

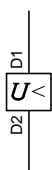

#### GV AS●●●



#### GV AX●●●

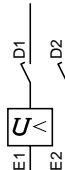

### Wiring diagram for undervoltage trip used on potentially dangerous machines, conforming to INRS

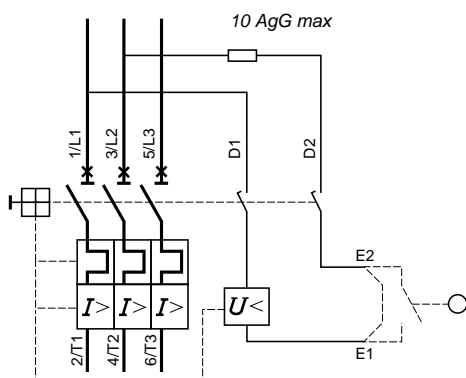

## Characteristics (1)

Conforming to standards	IEC 60947-4, IEC 60439-1, VDE 0660-102 and EN 60947
Degree of protection conforming to IEC 60529	GV2 LC: IP 547 GV NGC: IP 407
Operational voltage Ue	GV2 LC: 690 V GV NGC: 500 V
Material	Polycarbonate (2)

## References

Control by black rotary handle, padlockable in Off position (up to 3 padlocks with Ø 8 shank, to be ordered separately)

Rating In	Breaking capacity Icu conforming to IEC 60947-2				Magnetic tripping current I <sub>d</sub> ± 20 %	Reference	Weight kg
	220/ 230 V	400/ 415 V	440 V	500 V			
A	kA	kA	kA	kA	A		
1.6	100	100	100	100	13 In	GV2 LC0206 (3)	0.780
2.5	100	100	100	100	13 In	GV2 LC0207 (3)	0.780
4	100	100	100	100	13 In	GV2 LC0208 (3)	0.780
6.3	100	100	100	100	13 In	GV2 LC0210 (3)	0.780
10	100	100	20	10	13 In	GV2 LC0214 (3)	0.780
14	100	50	20	10	13 In	GV2 LC0216 (3)	0.780
18	100	50	20	10	13 In	GV2 LC0220 (3)	0.780
25	100	50	30	15	12 In	GV NGC0225	2.450
32	100	50	30	15	12 In	GV NGC0232	2.450
40	100	50	30	15	12 In	GV NGC0240	2.450
50	100	50	30	15	12 In	GV NGC0250	2.450
63	100	50	30	15	12 In	GV NGC0263	2.450

533740



GV2 LC02●●

533741



GV2 LC02●●

533742



GV NGC02●●

## Variants

### Starters with control by red rotary handle on yellow background

Add the letter R to the references selected above.  
Example: GV2 LC0206 becomes GV2 LC0206R.

### Enclosure without circuit-breaker, with rotary handle mounted on cover

Description	Rating	Reference	Weight kg
	A		
Black rotary handle	1.6...18	GV2 LC02	0.300
	25...63	GV NGC02	0.550
Red rotary handle on yellow background	1.6...18	GV2 LC02R	0.300
	25...63	GV NGC02R	0.550

533743



GV2 LC02

(1) Circuit-breaker characteristics:

GV2 L: see pages 24523/2 and 24523/3.

NG 125L: product marketed under the Merlin Gerin, brand, please consult your Regional Sales Office.

(2) Avoid placing this material in contact with harsh substances (detergents, chlorine solvents, ketones, alcohol, aromatic hydrocarbons).

(3) The following can be fitted by the customer: a GVAD or GVAM auxiliary contact block on the LH side and a GVA● trip on the RH side.

# TeSys enclosed starters

D.O.L. starters with manual control,  
with magnetic circuit-breaker, 0.55 to 30 kW

## Dimensions

GV2 LC0206...LC0220

GV NGC0225...NGC0263

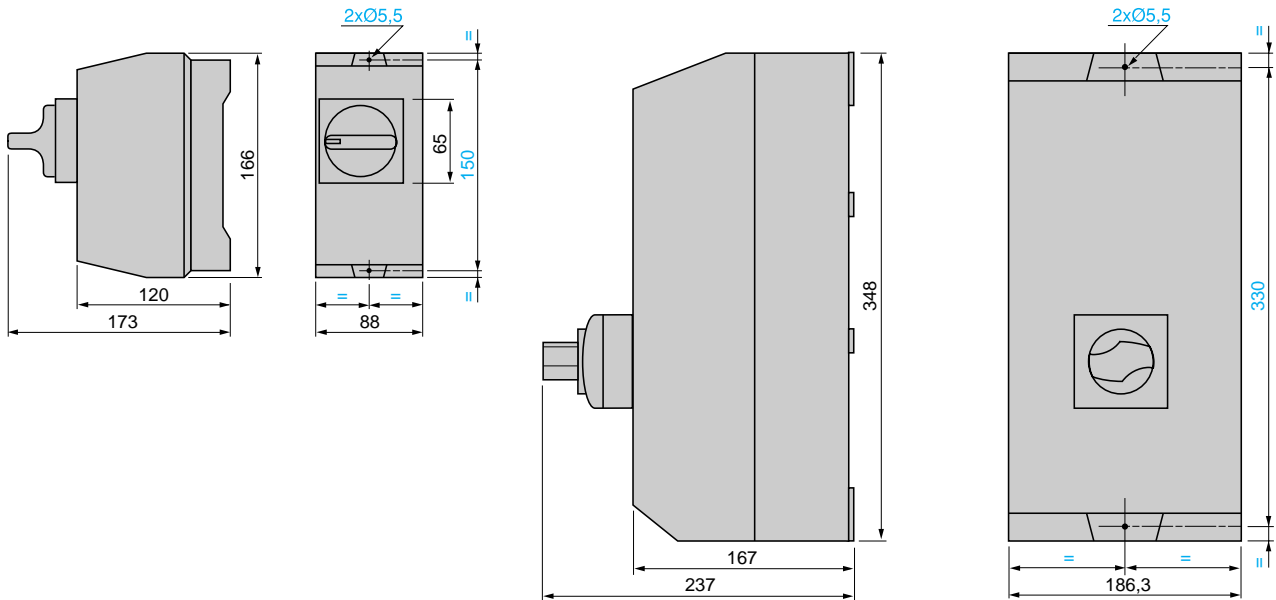

## Knock-outs or blanking plugs for cable glands

Enclosure type	At top	At bottom
	ISO	ISO
GV2 LC	2 x 20 or 2 x 25	2 x 20 or 2 x 25
GV NGC	2 x 20 or 2 x 25 or 2 x 32 or 2 x 40	2 x 20 or 2 x 25 or 2 x 32 or 2 x 40

## Scheme

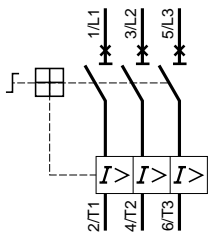

Old circuit-breaker		New circuit-breaker		
Reference	I <sub>cu</sub> / 400 V	Reference	I <sub>r</sub>	I <sub>cu</sub> / 400 V
<b>Thermal-magnetic motor circuit-breakers GV3 ME</b>				
GV3 ME06	100 kA	GV2 P06	1...1.6 A	> 100 kA
GV3 ME07	100 kA	GV2 P07	1.6...2.5 A	> 100 kA
GV3 ME08	100 kA	GV2 P08	2.5...4 A	> 100 kA
GV3 ME10	100 kA	GV2 P10	4...6 A	> 100 kA
GV3 ME14	100 kA	GV2 P14	6...10 A	> 100 kA
GV3 ME20	100 kA	GV3 P13	9...13 A	100 kA
		GV3 P18	12...18 A	100 kA
GV3 ME25	100 kA	GV3 P25	17...25 A	100 kA
GV3 ME40	35 kA	GV3 P32	23...32 A	100 kA
		GV3 P40	30...40 A	50 kA
GV3 ME63	35 kA	GV3 P50	37...50 A	50 kA
		GV3 P65	48...65 A	50 kA
Reference	I <sub>cu</sub> / 400 V	Reference	I <sub>e</sub>	I <sub>cu</sub> / 400 V
<b>Magnetic circuit-breakers GK3 EF</b>				
GK3 EF40	50 kA	GV3 L25	25 A	100 kA
		GV3 L32	32 A	100 kA
		GV3 L40	40 A	50 kA
GK3 EF65	35 kA	GV3 L50	50 A	50 kA
		GV3 L65	65 A	50 kA

Old enclosed circuit-breaker		New enclosed circuit-breaker	
Reference	Type of operator (not included)	Reference	Type of handle included
<b>Enclosed circuit-breakers GV3 ME</b>			
GV3 CE01	GV1K0●	GV3 PC01	GV2 AP01 (black)
		GV3 PC02	GV2 AP02 (red)



# The efficiency of Telemecanique branded *solutions*

Used in combination, Telemecanique products provide quality solutions, meeting all your **Automation** and **Control** applications requirements.



## A worldwide presence

### Constantly available

- More than 5 000 points of sale in 130 countries.
- You can be sure to find the range of products that are right for you and which complies fully with the standards in the country where they are used.

### Technical assistance wherever you are

- Our technicians are at your disposal to assist you in finding the optimum solution for your particular needs.
- Schneider Electric provides you with all necessary technical assistance, throughout the world.

[www.telemecanique.com](http://www.telemecanique.com)

### Schneider Electric Industries SAS

Head Office  
89, bd Franklin Roosevelt  
92506 Rueil-Malmaison Cedex  
France

[www.schneider-electric.com](http://www.schneider-electric.com)

Due to evolution of standards and equipment, the characteristics indicated in texts and images of this document do not constitute a commitment on our part without confirmation.

Design: Schneider Electric  
Photos: Schneider Electric

Printed by:

*Simply Smart !*

DI/A1ED2060503EN