

DMH 25x

Dosing pump

Installation and operating instructions



Declaration of conformity

GB: EC declaration of conformity

We, Grundfos, declare under our sole responsibility that the products DMH 251, DMH 252, DMH 253, DMH 254, DMH 255, DMH 256 and DMH 257, to which this declaration relates, are in conformity with these Council directives on the approximation of the laws of the EC member states:

- Machinery Directive (2006/42/EC).
Standards used: EN 809:1998+A1:2009,
EN ISO 12100-1+A1:2009,
EN ISO 12100-2+A1:2009.
 - Low Voltage Directive (2006/95/EC).
Standard used: EN 61010-1:2001 (second edition).
 - EMC Directive (2004/108/EC).*
- * Only for products with control variant AR or AT.

This EC declaration of conformity is only valid when published as part of the Grundfos installation and operating instructions.

DE: EG-Konformitätserklärung

Wir, Grundfos, erklären in alleiniger Verantwortung, dass die Produkte DMH 251, DMH 252, DMH 253, DMH 254, DMH 255, DMH 256 und DMH 257, auf die sich diese Erklärung bezieht, mit den folgenden Richtlinien des Rates zur Angleichung der Rechtsvorschriften der EU-Mitgliedsstaaten übereinstimmen:

- Maschinenrichtlinie (2006/42/EG).
Normen, die verwendet wurden: EN 809:1998+A1:2009,
EN ISO 12100-1+A1:2009,
EN ISO 12100-2+A1:2009.
 - Niederspannungsrichtlinie (2006/95/EG).
Norm, die verwendet wurde: EN 61010-1:2001 (zweite Ausgabe).
 - EMV-Richtlinie (2004/108/EG).*
- * Nur für Produkte mit Steuerungsvariante AR oder AT.

Diese EG-Konformitätserklärung gilt nur, wenn sie in Verbindung mit der Grundfos Montage- und Betriebsanleitung veröffentlicht wird.

ES: Declaración CE de conformidad

Nosotros, Grundfos, declaramos bajo nuestra entera responsabilidad que los productos DMH 251, DMH 252, DMH 253, DMH 254, DMH 255, DMH 256 y DMH 257, a los cuales se refiere esta declaración, están conformes con las Directivas del Consejo en la aproximación de las leyes de los Estados Miembros del EM:

- Directiva de Maquinaria (2006/42/CE).
Normas aplicadas: EN 809:1998+A1:2009,
EN ISO 12100-1+A1:2009,
EN ISO 12100-2+A1:2009.
 - Directiva de Baja Tensión (2006/95/CE).
Norma aplicada: EN 61010-1:2001 (segunda edición).
 - Directiva EMC (2004/108/CE).*
- * Solo para productos con variante de control AR o AT.

Esta declaración CE de conformidad sólo es válida cuando se publique como parte de las instrucciones de instalación y funcionamiento de Grundfos.

HR: EZ izjava o usklađenosti

Mi, Grundfos, izjavljujemo pod vlastitom odgovornošću da je proizvod DMH 251, DMH 252, DMH 253, DMH 254, DMH 255, DMH 256 i DMH 257, na koji se ova izjava odnosi, u skladu s direktivama ovog Vijeća o usklađivanju zakona država članica EU:

- Direktiva za strojeve (2006/42/EZ).
Korištene norme: EN 809:1998+A1:2009,
EN ISO 12100-1+A1:2009,
EN ISO 12100-2+A1:2009.
 - Direktiva za niski napon (2006/95/EZ).
Korištena norma: EN 61010-1:2001 (drugo izdanje).
 - Direktiva za elektromagnetsku kompatibilnost (2004/108/EZ).*
- * Samo za proizvode s vrstom upravljanja AR ili AT.

Ova EZ izjava o sukladnosti važeća je jedino kada je izdana kao dio Grundfos montažnih i pogonskih uputa.

CZ: ES prohlášení o shodě

My firma Grundfos prohlašujeme na svou plnou odpovědnost, že výrobky DMH 251, DMH 252, DMH 253, DMH 254, DMH 255, DMH 256 a DMH 257, na něž se toto prohlášení vztahuje, jsou v souladu s ustanoveními směrnice Rady pro sblížení právních předpisů členských států Evropského společenství v oblastech:

- Směrnice pro strojní zařízení (2006/42/ES).
Použité normy: EN 809:1998+A1:2009,
EN ISO 12100-1+A1:2009,
EN ISO 12100-2+A1:2009.
 - Směrnice pro nízkonapěťové aplikace (2006/95/ES).
Použitá norma: EN 61010-1:2001 (druhé vydání).
 - Směrnice pro elektromagnetickou kompatibilitu (EMC) (2004/108/ES).*
- * Pouze pro výrobky s variantou řízení AR nebo AT.

Toto ES prohlášení o shodě je platné pouze tehdy, pokud je zveřejněno jako součást instalačních a provozních návodů Grundfos.

GR: Δήλωση συμμόρφωσης EC

Εμείς, η Grundfos, δηλώνουμε με αποκλειστικά δική μας ευθύνη ότι τα προϊόντα DMH 251, DMH 252, DMH 253, DMH 254, DMH 255, DMH 256 και DMH 257 στα οποία αναφέρεται η παρούσα δήλωση, συμμορφώνονται με τις εξής Οδηγίες του Συμβουλίου περί προσέγγισης των νομοθεσιών των κρατών μελών της ΕΕ:

- Οδηγία για μηχανήματα (2006/42/ΕΚ).
Πρότυπα που χρησιμοποιήθηκαν: EN 809:1998+A1:2009,
EN ISO 12100-1+A1:2009,
EN ISO 12100-2+A1:2009.
 - Οδηγία χαμηλής τάσης (2006/95/ΕΚ).
Πρότυπο που χρησιμοποιήθηκε: EN 61010-1:2001 (δεύτερη έκδοση).
 - Οδηγία Ηλεκτρομαγνητικής Συμβατότητας (EMC) (2004/108/ΕΚ).*
- * Μόνο για προϊόντα με τύπο ελέγχου AR ή AT.

Αυτή η δήλωση συμμόρφωσης EC ισχύει μόνον όταν συνοδεύει τις οδηγίες εγκατάστασης και λειτουργίας της Grundfos.

FR: Déclaration de conformité CE

Nous, Grundfos, déclarons sous notre seule responsabilité, que les produits DMH 251, DMH 252, DMH 253, DMH 254, DMH 255, DMH 256 et DMH 257, auxquels se réfère cette déclaration, sont conformes aux Directives du Conseil concernant le rapprochement des législations des Etats membres CE relatives aux normes énoncées ci-dessous :

- Directive Machines (2006/42/CE).
Normes utilisées : EN 809:1998+A1:2009,
EN ISO 12100-1+A1:2009,
EN ISO 12100-2+A1:2009.
 - Directive Basse Tension (2006/95/CE).
Norme utilisée : EN 61010-1:2001 (deuxième édition).
 - Directive Compatibilité Electromagnétique CEM (2004/108/CE).*
- * Uniquement pour produits avec variante de commande AR ou AT.

Cette déclaration de conformité CE est uniquement valide lors de sa publication dans la notice d'installation et de fonctionnement Grundfos.

IT: Dichiarazione di conformità CE

Grundfos dichiara sotto la sua esclusiva responsabilità che i prodotti DMH 251, DMH 252, DMH 253, DMH 254, DMH 255, DMH 256 e DMH 257, ai quali si riferisce questa dichiarazione, sono conformi alle seguenti direttive del Consiglio riguardanti il riavvicinamento delle legislazioni degli Stati membri CE:

- Direttiva Macchine (2006/42/CE).
Norme applicate: EN 809:1998+A1:2009,
EN ISO 12100-1+A1:2009,
EN ISO 12100-2+A1:2009.
 - Direttiva Bassa Tensione (2006/95/CE).
Norma applicata: EN 61010-1:2001 (seconda edizione).
 - Direttiva EMC (2004/108/CE).*
- * Solo per prodotti con varianti di controllo AR o AT.

Questa dichiarazione di conformità CE è valida solo quando pubblicata come parte delle istruzioni di installazione e funzionamento Grundfos.

HU: EK megfelelőségi nyilatkozat

Mi, a Grundfos, egyedüli felelősséggel kijelentjük, hogy a DMH 251, DMH 252, DMH 253, DMH 254, DMH 255, DMH 256 és DMH 257 termékek, amelyekre jelen nyilatkozik vonatkozik, megfelelnek az Európai Unió tagállamainak jogi irányelveit összehangoló tanács alábbi előírásainak:

- Gépek (2006/42/EK).
Alkalmazott szabványok: EN 809:1998+A1:2009,
EN ISO 12100-1+A1:2009,
EN ISO 12100-2+A1:2009.
- Kifeszültségű Direktíva (2006/95/EK).
Alkalmazott szabvány: EN 61010-1:2001 (második kiadás).
- EMC Direktíva (2004/108/EK).*

* Csak AR illetve AT vezérlési változat esetén.

Ez az EK megfelelőségi nyilatkozat kizárólag akkor érvényes, ha Grundfos telepítési és üzemeltetési utasítás részeként kerül kiadásra.

PL: Deklaracja zgodności WE

My, Grundfos, oświadczamy z pełną odpowiedzialnością, że nasze wyroby DMH 251, DMH 252, DMH 253, DMH 254, DMH 255, DMH 256 i DMH 257, których deklaracja niniejsza dotyczy, są zgodne z następującymi wytycznymi Rady d/s ujednolicenia przepisów prawnych krajów członkowskich WE:

- Dyrektywa Maszynowa (2006/42/WE).
Zastosowane normy: EN 809:1998+A1:2009,
EN ISO 12100-1+A1:2009,
EN ISO 12100-2+A1:2009.
- Dyrektywa Niskonapięciowa (LVD) (2006/95/WE).
Zastosowana norma: EN 61010-1:2001 (drugie wydanie).
- Dyrektywa EMC (2004/108/WE).*

* Tylko dla produktów w wersji sterowania AR lub AT.

Deklaracja zgodności WE jest ważna tylko i wyłącznie wtedy kiedy jest opublikowana przez firmę Grundfos i umieszczona w instrukcji montażu i eksploatacji.

RU: Декларация о соответствии ЕС

Мы, компания Grundfos, со всей ответственностью заявляем, что изделия DMH 251, DMH 252, DMH 253, DMH 254, DMH 255, DMH 256 и DMH 257, к которым относится настоящая декларация, соответствуют следующим Директивам Совета Евросоюза об унификации законодательных предписаний стран-членов ЕС:

- Механические устройства (2006/42/ЕС).
Применявшиеся стандарты: EN 809:1998+A1:2009,
EN ISO 12100-1+A1:2009,
EN ISO 12100-2+A1:2009.
- Низковольтное оборудование (2006/95/ЕС).
Применявшийся стандарт: EN 61010-1:2001 (второе издание).
- Электромагнитная совместимость (2004/108/ЕС).*

* Только для насосов с блоком управления AR или AT.

Данная декларация о соответствии ЕС имеет силу только в случае публикации в составе инструкции по монтажу и эксплуатации на продукцию производства компании Grundfos.

SE: EG-försäkran om överensstämmelse

Vi, Grundfos, försäkras under ansvar att produkterna DMH 251, DMH 252, DMH 253, DMH 254, DMH 255, DMH 256 och DMH 257, som omfattas av denna försäkran, är i överensstämmelse med rådets direktiv om inbördes närmande till EU-medlemsstaternas lagstiftning, avseende:

- Maskindirektivet (2006/42/EG).
Tillämpade standarder: EN 809:1998+A1:2009,
EN ISO 12100-1+A1:2009,
EN ISO 12100-2+A1:2009.
- Lågspänningsdirektivet (2006/95/EG).
Tillämpad standard: EN 61010-1:2001 (andra upplagan).
- EMC-direktivet (2004/108/EG).*

* Endast för produkter med styrenhetsvariant AR eller AT.

Denna EG-försäkran om överensstämmelse är endast giltig när den publiceras som en del av Grundfos monterings- och driftsinstruktion.

CN: EC 产品合格声明书

我们格兰富在我们的全权责任下声明，产品 DMH 251, DMH 252, DMH 253, DMH 254, DMH 255, DMH 256 和 DMH 257，即该合格证所指之产品，符合欧共体使其成员国法律趋于一致的以下欧共理事会指令：

- 机械设备指令 (2006/42/EC)。
所用标准：EN 809:1998+A1:2009,
EN ISO 12100-1+A1:2009,
EN ISO 12100-2+A1:2009。
- 低电压指令 (2006/95/EC)。
所用标准：EN 61010-1:2001 (第 2 版)。
- 电磁兼容性指令 (2004/108/EC)。*

* 仅对控制选项为 AR 或 AT 的型号有效。

本 EC 合格性声明仅在作为格兰富安装与操作指导手册的一部分时有效。

NL: EC overeenkomstigheidsverklaring

Wij, Grundfos, verklaren geheel onder eigen verantwoordelijkheid dat de producten DMH 251, DMH 252, DMH 253, DMH 254, DMH 255, DMH 256 en DMH 257 waarop deze verklaring betrekking heeft, in overeenstemming zijn met de Richtlijnen van de Raad in zake de onderlinge aanpassing van de wetgeving van de EG Lidstaten betreffende:

- Machine Richtlijn (2006/42/EC).
Gebruikte normen: EN 809:1998+A1:2009,
EN ISO 12100-1+A1:2009,
EN ISO 12100-2+A1:2009.
- Laagspannings Richtlijn (2006/95/EC).
Gebruikte norm: EN 61010-1:2001 (tweede editie).
- EMC Richtlijn (2004/108/EC).*

* Enkel voor producten met besturingsvariant AR of AT.

Deze EC overeenkomstigheidsverklaring is alleen geldig wanneer deze gepubliceerd is als onderdeel van de Grundfos installatie- en bedieningsinstructies.

PT: Declaração de conformidade CE

A Grundfos declara sob sua única responsabilidade que os produtos DMH 251, DMH 252, DMH 253, DMH 254, DMH 255, DMH 256 e DMH 257, aos quais diz respeito esta declaração, estão em conformidade com as seguintes Directivas do Conselho sobre a aproximação das legislações dos Estados Membros da CE:

- Directiva Máquinas (2006/42/CE).
Normas utilizadas: EN 809:1998+A1:2009,
EN ISO 12100-1+A1:2009,
EN ISO 12100-2+A1:2009.
- Directiva Baixa Tensão (2006/95/CE).
Norma utilizada: EN 61010-1:2001 (segunda edição).
- Directiva EMC (compatibilidade electromagnética) (2004/108/CE).*

* Apenas para produtos com sistema de controlo AR ou AT.

Esta declaração de conformidade CE é apenas válida quando publicada como parte das instruções de instalação e funcionamento Grundfos.

SI: ES izjava o skladnosti

V Grundfosu s polno odgovornostjo izjavljamo, da so naši izdelki DMH 251, DMH 252, DMH 253, DMH 254, DMH 255, DMH 256 in DMH 257, na katere se ta izjava nanaša, v skladu z naslednjimi direktivami Sveta o približevanju zakonodaje za izenačevanje pravnih predpisov držav članic ES:

- Direktiva o strojih (2006/42/ES).
Uporabljeni normi: EN 809:1998+A1:2009,
EN ISO 12100-1+A1:2009,
EN ISO 12100-2+A1:2009.
- Direktiva o nizki napetosti (2006/95/ES).
Uporabljena norma: EN 61010-1:2001 (druga izdaja).
- Direktiva o elektromagnetni združljivosti (EMC) (2004/108/ES).*

* Samo za izdelke z kontrolno različico AR ali AT.

ES izjava o skladnosti velja samo kadar je izdana kot del Grundfos instalacije in navodil delovanja.

TR: EC uygunluk bildirgesi

Grundfos olarak bu beyannameye konu olan DMH 251, DMH 252, DMH 253, DMH 254, DMH 255, DMH 256 ve DMH 257 ürünlerinin, AB Üyesi Ülkelerin kanunlarını birbirine yaklaştırmaya üzerine Konsey Direktifleriyle uyumlu olduğunu yalnızca bizim sorumluluğumuz altında olduğunu beyan ederiz:

- Makineler Yönetmeliği (2006/42/EC).
Kullanılan standartlar: EN 809:1998+A1:2009,
EN ISO 12100-1+A1:2009,
EN ISO 12100-2+A1:2009.
- Düşük Voltaj Yönetmeliği (2006/95/EC).
Kullanılan standart: EN 61010-1:2001 (ikinci baskı).
- EMC Direktifi (2004/108/EC).*

* Sadece AR ve AT kontrol değişikliği için.

- İşbu EC uygunluk bildirgesi, yalnızca Grundfos kurulum ve çalıştırma talimatlarının bir parçası olarak basıldığı takdirde geçerlilik kazanmaktadır.

Pfintzal, 15th May, 2012



Ulrich Stemick
Technical Director
Grundfos Water Treatment GmbH
Reetzstr. 85, D-76327 Pfintzal, Germany

Person authorised to compile technical file and empowered to sign the EC declaration of conformity

Original installation and operating instructions.

CONTENTS

	Page		Page
1. General	4	12. Operation	29
1.1 Introduction	4	12.1 Switching on/off	29
1.2 Service documentation	4	12.2 Setting the dosing capacity	29
2. Installation data	5	12.3 Using the AR control unit (optional)	29
3. Installation sketch	5	12.4 Electric servomotor (optional)	29
4. General information	6	12.5 Electronic preselection counter (optional)	29
4.1 Applications	6	12.6 Electrically heated dosing head (optional)	29
4.2 Warranty	6	13. Maintenance	29
5. Safety	6	13.1 General notes	29
5.1 Identification of safety instructions in this manual	6	13.2 Diaphragm leakage control for diaphragm leakage detection	29
5.2 Qualification and training of personnel	6	13.3 Cleaning and maintenance intervals	30
5.3 Risks when safety instructions are not observed	6	13.4 Checking the oil level	30
5.4 Safety-conscious working	6	13.5 Cleaning the suction and discharge valves	30
5.5 Safety instructions for the operator/user	6	13.6 Replacing the diaphragm and gear oil for dosing head with single diaphragm (no diaphragm leakage detection)	31
5.6 Safety instructions for maintenance, inspection and installation work	6	13.7 Replacing the diaphragm for dosing head with double diaphragm	32
5.7 Unauthorised modification and manufacture of spare parts	7	14. Fault finding chart	35
5.8 Improper operating methods	7	15. Dosing curves	37
5.9 Safety of the system in the event of a failure in the dosing system	7	16. Disposal	51
6. Technical data	7		
6.1 Identification	7		
6.2 Type key	8		
6.3 Pump types	9		
6.4 Pump performance	9		
6.5 Sound pressure level	12		
6.6 Electrical data	12		
6.7 AR control unit	12		
6.8 Power supply	12		
6.9 Ambient and operating conditions	12		
6.10 Dosing medium	12		
7. Transport and storage	13		
7.1 Delivery	13		
7.2 Unpacking	13		
7.3 Intermediate storage	13		
7.4 Return	13		
8. Product description and accessories	14		
8.1 General description	14		
8.2 Dimensional sketches	18		
8.3 Weight	20		
8.4 Stroke volume	20		
8.5 Materials	20		
8.6 Data of contact pressure gauge for diaphragm leakage detection (optional)	20		
9. Installation	20		
9.1 General information on installation	20		
9.2 Installation location	20		
9.3 Mounting	20		
9.4 Approximate values when using pulsation dampers	21		
9.5 Optimum installation	22		
9.6 Installation tips	22		
9.7 Tube / pipe lines	23		
9.8 Connecting the suction and discharge lines	23		
10. Electrical connections	24		
10.1 Electric servomotor (optional)	24		
10.2 Electronic preselection counter (optional)	24		
10.3 Electrically heated dosing head (optional)	24		
10.4 Diaphragm controller (optional)	25		
10.5 Connecting the power supply cable	25		
11. Start-up/shutdown	25		
11.1 Initial start-up/subsequent start-up	25		
11.2 Start-up/subsequent start-up of DMH 251, 252 and 253	26		
11.3 Start-up/subsequent start-up of DMH 254, 255 and 257	26		

Warning

These complete installation and operating instructions are also available on www.Grundfosalldos.com.



Prior to installation, read these installation and operating instructions. Installation and operation must comply with local regulations and accepted codes of good practice.

1. General**1.1 Introduction**

These installation and operating instructions contain all the information required for starting up and handling the DMH 25x piston diaphragm dosing pump.

If you require further information or if any problems arise, which are not described in detail in this manual, please contact the nearest Grundfos company.

1.2 Service documentation

If you have any questions, please contact the nearest Grundfos company or service workshop.

2. Installation data

Note

*Please fill in the data below after commissioning.
It will help you and your Grundfos service partner
to make subsequent adjustments to the
installation.*

Owner:

Grundfos customer number:

Order number:

Product number:

Pump serial number:

Put into service on:

Location of pump:

Used for:

3. Installation sketch

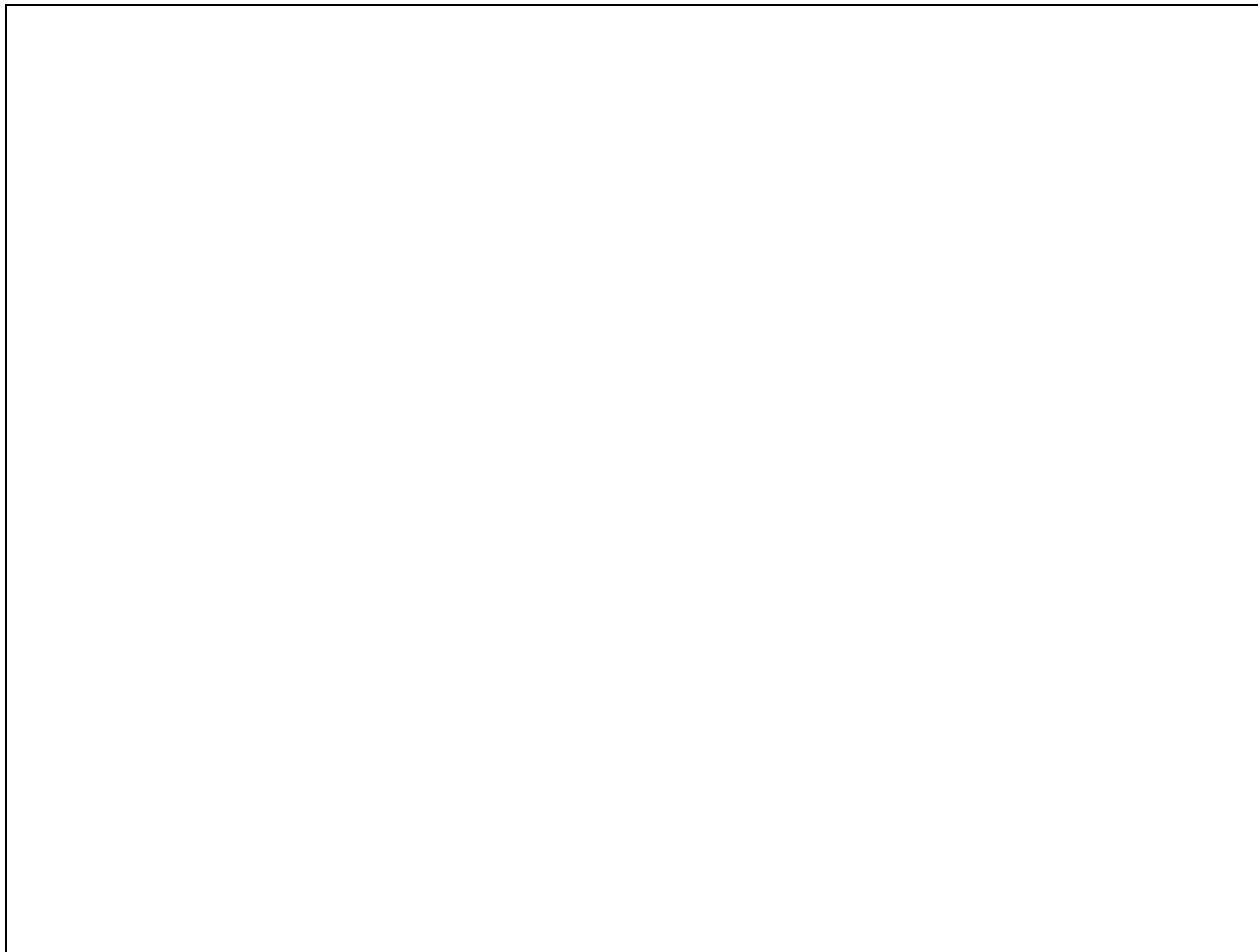

4. General information

4.1 Applications

The DMH 25x pump is suitable for liquid, non-abrasive and non-inflammable media strictly in accordance with the instructions in this manual.

Note

Explosion-proof pumps are identified from the pump and motor nameplates. An EC declaration of conformity is provided in accordance with the EC directive 94/9/EC, the so-called ATEX directive. This declaration of conformity replaces the declaration of conformity in this manual.

Warning



To operate a pump which has been identified as an explosion-proof pump for the dosing of inflammable media or for operation in potentially explosive operating sites in accordance with the EC directive 94/9/EC, refer to the enclosed manual "Operating an explosion-proof pump" in addition to this manual.

Warning



Other applications or the operation of pumps in ambient and operating conditions, which are not approved, are considered improper and are not permitted. Grundfos accepts no liability for any damage resulting from incorrect use.

4.2 Warranty

Warranty in accordance with our general terms of sale and delivery is only valid

- if the pump is used in accordance with the information within this manual.
- if the pump is not dismantled or incorrectly handled.
- if repairs are carried out by authorised and qualified personnel.
- if original spare parts are used for repairs.

5. Safety

This manual contains general instructions that must be observed during installation, operation and maintenance of the pump.

This manual must therefore be read by the installation engineer and the relevant qualified personnel/operators prior to installation and start-up, and must be available at the installation location of the pump at all times.

It is not only the general safety instructions given in this "Safety" section that must be observed, but all special safety instructions given in the other sections.

5.1 Identification of safety instructions in this manual

If the safety instructions or other advice in this manual are not observed, it may result in personal injury or malfunction and damage to the pump. The safety instructions and other advice are identified by the following symbols:



Warning

If these safety instructions are not observed, it may result in personal injury!

Caution

If these safety instructions are not observed, it may result in malfunction or damage to the equipment!

Note

Notes or instructions that make the job easier and ensure safe operation.

Information provided directly on the pump, e.g. labelling of fluid connections, must be maintained in a readable condition at all times.

5.2 Qualification and training of personnel

The personnel responsible for the operation, maintenance, inspection and installation must be appropriately qualified for these tasks. Areas of responsibility, levels of authority and the supervision of the personnel must be precisely defined by the operator.

If the personnel do not have the necessary knowledge, the necessary training and instruction must be given.

If necessary, training can be performed by the manufacturer/supplier at the request of the operator of the pump. It is the responsibility of the operator to make sure that the contents of this manual are understood by the personnel.

5.3 Risks when safety instructions are not observed

Non-observance of the safety instructions may have dangerous consequences for the personnel, the environment and the pump. If the safety instructions are not observed, all rights to claims for damages may be lost.

Non-observance of the safety instructions may lead to the following hazards:

- failure of important functions of the pump/system
- failure of specified methods for maintenance
- harm to humans from exposure to electrical, mechanical and chemical influences
- damage to the environment from leakage of harmful substances.

5.4 Safety-conscious working

The safety instructions in this manual, applicable national health and safety regulations and any operator internal working, operating and safety regulations must be observed.

5.5 Safety instructions for the operator/user

Hazardous hot or cold parts on the pump must be protected to prevent accidental contact.

Leakages of dangerous substances (e.g. hot, toxic) must be disposed of in a way that is not harmful to the personnel or the environment. Legal regulations must be observed.

Damage caused by electrical energy must be prevented (for more details, see for example the regulations of the VDE and the local electricity supply company).

5.6 Safety instructions for maintenance, inspection and installation work

The operator must ensure that all maintenance, inspection and installation work is carried out by authorised and qualified personnel, who have been adequately trained by reading this manual.

All work on the pump should only be carried out when the pump is stopped. The procedure described in this manual for stopping the pump must be observed.

Pumps or pump units which are used for media that are harmful to health must be decontaminated.

All safety and protective equipment must be immediately restarted or put into operation once work is complete.

Observe the points described in the initial start-up section prior to subsequent start-up.

Warning

The pump must be installed in a position where it is easily accessible during operation and maintenance work.



Observe the flow direction of valves (indicated by an arrow on the valve)!

Only tighten plastic valves by hand.

Only use the prescribed line types!

Electrical connections must only be carried out by qualified personnel!

**Warning**

Make sure that the pump is suitable for the actual dosing medium!

Observe the chemical manufacturer's safety instructions when handling chemicals!

Do not operate the pump next to closed valves.

Warning

The pump housing, control unit and sensors must only be opened by personnel authorised by Grundfos!

Repairs must only be carried out by authorised and qualified personnel!



Wear protective clothing (gloves and goggles) when working on the dosing head, connections or lines!

Before removing the dosing head, valves and lines, empty any remaining medium in the dosing head into a drip tray by carefully unscrewing the suction valve.

The resistance of the parts that come into contact with the media depends on the media, media temperature and operating pressure. Ensure that parts in contact with the media are chemically resistant to the dosing medium under operating conditions!

Caution

5.7 Unauthorised modification and manufacture of spare parts

Modification or changes to the pump are only permitted following agreement with the manufacturer. Original spare parts and accessories authorised by the manufacturer are safe to use. Using other parts can result in liability for any resulting consequences.

5.8 Improper operating methods

The operational safety of the supplied pump is only ensured if it is used in accordance with section 6. *Technical data*. The specified limit values must under no circumstances be exceeded.

Explosion-proof pumps are identified from the pump and motor nameplates. An EC declaration of conformity is provided in accordance with the EC directive 94/9/EC, the so-called ATEX directive. This declaration of conformity replaces the declaration of conformity in this manual.

Note**Warning**

To operate a pump which has been identified as an explosion-proof pump for the dosing of inflammable media or for operation in potentially explosive operating sites in accordance with the EC directive 94/9/EC, refer to the enclosed manual "Operating an explosion-proof pump" in addition to this manual.



If the assumption is made that a safe operation is no longer possible, switch off the pump and protect it against unintentional operation.

This action should be taken

- if the pump has been damaged.
- if the pump no longer seems to be operational.
- if the pump has been stored for an extended period of time in poor conditions.

5.9 Safety of the system in the event of a failure in the dosing system

DMH 25x dosing pumps are designed according to the latest technologies and are carefully manufactured and tested. However, a failure may occur in the dosing system. Systems in which dosing pumps are installed must be designed in such a way that the safety of the entire system is still ensured following a failure of the dosing pump. Provide the relevant monitoring and control functions for this.

6. Technical data

6.1 Identification



Fig. 1 DMH nameplate

Pos.	Description
1	Type designation
2	Model
3	Maximum capacity [l/h]
4	Voltage [V]
5	Frequency [Hz]
6	Product number
7	Country of origin
8	Year and week code
9	Marks of approval, CE mark, etc.
10	Maximum pressure [bar]
11	Serial number

TM03 8688 1612

6.2 Type key

Example:		DMH 100 - 10 AR PP /E /T -F -G 1 B9B9 F E0									
Type range		Motor variant									
DMH		E0 PTC motor for frequency control									
Maximum flow [l/h]		E1 Motor type EEx de C T3, 3 x 400 V, 50 Hz									
Maximum pressure [bar]		E2 Motor type EEx de C T4, 3 x 400 V, 50 Hz									
Control variant		E3 API approval									
B Standard		Mains plug									
AR* AR control unit (analog/pulse control)		X No plug									
S1 Stroke output		F EU (Schuko)									
AT0 Prepared for servomotor		B USA, Canada									
AT3 Servomotor, 1 x 230 V, 50/60 Hz supply, 4-20 mA control		I Australia, New Zealand, Taiwan									
AT5 Servomotor, 1 x 115 V, 50/60 Hz supply, 4-20 mA control		E Switzerland									
AT6 Servomotor, 1 x 230 V, 50/60 Hz supply, 4-20 mA control, EEx d II BT 4		Connection, suction/discharge									
AT7 Servomotor, 1 x 115 V, 50/60 Hz supply, 4-20 mA control, EEx d II BT 4		B6 Pipe, 4/6 mm									
AT8 Servomotor, 1 x 230 V, 50/60 Hz supply, 4-20 mA control, 1 kΩ potentiometer		C2 Pipe, 8/10 mm									
AT9 Servomotor, 1 x 115 V, 50/60 Hz supply, 4-20 mA control, 1 kΩ potentiometer		C4 Pipe, 20/25 mm									
Dosing head variant		4 Tube, 6/9 mm									
PP Polypropylene		6 Tube, 9/12 mm									
PV PVDF (polyvinylidene fluoride)		B9 Tube, 19/27 mm, PVC									
PVC Polyvinyl chloride		Q Tube, 19/27 mm and 25/34 mm									
SS Stainless steel, DIN 1.4571		S Tube, 3/8" / 1/2"									
Y Hastelloy® C		A Threaded, Rp 1/4, female									
PP-L PP + integrated diaphragm leakage detection		A1 Threaded, Rp 3/4, female									
PV-L PVDF + integrated diaphragm leakage detection		V Threaded, 1/4" NPT, female									
PVC-L PVC + integrated diaphragm leakage detection		A9 Threaded, 1/2" NPT, male									
SS-L SS + integrated diaphragm leakage detection		A3 Threaded, 3/4" NPT, female									
Y-L Y + integrated diaphragm leakage detection		A7 Threaded, 3/4" NPT, male									
SS-H SS + heating flange in dosing head (electric)		B8 Cementing d. 40 mm and flange DN 32									
Gasket material		B1 Tube 6/12 mm/cementing d. 12 mm									
E EPDM		B2 Tube 13/20 mm/cementing d. 25 mm									
V FKM		B3 Welding d. 16 mm									
T PTFE		B4 Welding d. 25 mm									
Valve ball material		B7 Welding d. 40 mm and flange DN 32									
C Ceramics		C1 Welding flange DN 32, stainless steel									
G Glass		P Flange 1 1/4"									
T PTFE		Valve type									
SS Stainless steel, DIN 1.4401		1 Standard									
Y Hastelloy® C		2 Spring-loaded 0.05 bar suction opening pressure; 0.05 bar discharge opening pressure									
Control panel position		3 Spring-loaded 0.05 bar suction opening pressure; 0.8 bar discharge opening pressure									
X No control panel		4 Spring-loaded, discharge side only, 0.8 bar opening pressure									
F Front-mounted (opposite to the dosing head)		5 For abrasive media									
S Side-mounted (same side as the stroke-length adjustment knob)		Supply voltage									
Sx Side-mounted (side opposite to the stroke-length adjustment knob)		0 Without motor, IEC flange									
W Wall-mounted		F Without motor, NEMA flange (US)									
		G 1 x 230 V, 50/60 Hz									
		H 1 x 120 V, 50/60 Hz									
		5 3 x 230/460 V, 60 Hz									
		E 230/400 V, 50/60 Hz 440/480 V, 60 Hz									
		K 3 x 500 V 50 Hz									

* Only pumps up to and including 0.37 kW and only single-phase pumps

6.3 Pump types

The DMH 25x dosing pump is available for a variety of performance ranges in various sizes. Pump type and designation, see pump nameplate.

The following is indicated on the pump nameplate (see section 6.1 *Identification*):

- The pump type which specifies the stroke volume, connection size and performance data (see below).
- The pump serial number which is used to identify the pump.
- The most important characteristics of the pump configuration e.g. for dosing head and valve materials. They are described in section 6.2 *Type key*.
- Maximum flow rate and maximum counter-pressure.
- Mains frequency.

The following is indicated on the motor nameplate:

- required energy
- mains frequency
- power consumption
- enclosure class.

6.4 Pump performance

Performance data at maximum pump counter-pressure

Pump type		50 Hz			60 Hz			100 Hz		
Single pump	Double pump	Q*	p max.	Max. stroke rate	Q*	p max.	Max. stroke rate	Q*	p max.	Max. stroke rate
		[l/h]	[bar]	[n/min]	[l/h]	[bar]	[n/min]	[l/h]	[bar]	[n/min]
DMH 251										
DMH 2.4-10	DMH 2.4-10/2.4-10	2.4	10	14	2.9	10	17	5	10	29
DMH 5-10	DMH 5-10/5-10	5	10	29	6	10	35	10	10	58
DMH 13-10	DMH 13-10/13-10	13	10	63	16	10	75	25	10	126
DMH 19-10	DMH 19-10/19-10	19	10	96	23	10	115	—	—	—
DMH 24-10	DMH 24-10/24-10	24	10	120	—	—	—	—	—	—
DMH 2.3-16	DMH 2.3-16/2.3-16	2.3	16	14	2.8	16	17	4.5	16	29
DMH 4.9-16	DMH 4.9-16/4.9-16	4.9	16	29	5.9	16	35	9.8	16	58
DMH 12-16	DMH 12-16/12-16	12	16	63	14	16	75	24	16	126
DMH 18-16	DMH 18-16/18-16	18	16	96	22	16	115	—	—	—
DMH 23-16	DMH 23-16/23-16	23	16	120	—	—	—	—	—	—
DMH 2.2-25	DMH 2.2-25/2.2-25	2.2	25	14	2.6	25	17	4.4	25	29
DMH 4.5-25	DMH 4.5-25/4.5-25	4.5	25	29	5.4	25	35	9	25	58
DMH 11-25	DMH 11-25/11-25	11	25	63	13	25	75	22	25	126
DMH 17-25	DMH 17-25/17-25	17	25	96	20	25	115	—	—	—
DMH 21-25	DMH 21-25/21-25	21	25	120	—	—	—	—	—	—
DMH 252										
DMH 11-10	DMH 11-10/11-10	11	10	29	13	10	35	22	10	58
DMH 24-10	DMH 24-10/24-10	24	10	63	29	10	75	48	10	126
DMH 37-10	DMH 37-10/37-10	37	10	96	44	10	115	—	—	—
DMH 46-10	DMH 46-10/46-10	46	10	120	—	—	—	—	—	—
DMH 10-16	DMH 10-16/10-16	10	16	29	12	16	35	20	16	58
DMH 23-16	DMH 23-16/23-16	23	16	63	27	16	75	46	16	126
DMH 36-16	DMH 36-16/36-16	36	16	96	43	16	115	—	—	—
DMH 45-16	DMH 45-16/45-16	45	16	120	54	16	144	—	—	—
DMH 54-16	DMH 54-16/54-16	54	16	144	—	—	—	—	—	—
DMH 253										
DMH 21-10	DMH 21-10/21-10	21	10	29	25	10	35	46	10	58
DMH 43-10	DMH 43-10/43-10	43	10	63	52	10	75	87	10	126
DMH 67-10	DMH 67-10/67-10	67	10	96	78	10	115	—	—	—
DMH 83-10	DMH 83-10/83-10	83	10	120	99	10	144	—	—	—
DMH 100-10	DMH 100-10/100-10	100	10	144	—	—	—	—	—	—

Pump type		50 Hz			60 Hz			100 Hz		
Single pump	Double pump	Q*	p max.	Max. stroke rate	Q*	p max.	Max. stroke rate	Q*	p max.	Max. stroke rate
		[l/h]	[bar]	[n/min]	[l/h]	[bar]	[n/min]	[l/h]	[bar]	[n/min]
DMH 254										
DMH 50-10	DMH 50-10/50-10	50	10	26	60	10	31	101	10	52
DMH 102-10	DMH 102-10/102-10	102	10	54	122	10	65	203	10	108
DMH 143-10	DMH 143-10/143-10	143	10	75	172	10	90	286	10	150
DMH 175-10	DMH 175-10/175-10	175	10	92	210	10	110	—	—	—
DMH 213-10	DMH 213-10/213-10	213	10	112	255	10	134	—	—	—
DMH 291-10	DMH 291-10/291-10	291	10	153	—	—	—	—	—	—
DMH 46-16	DMH 46-16/46-16	46	16	26	55	16	31	92	16	52
DMH 97-16	DMH 97-16/97-16	97	16	54	116	16	65	193	16	108
DMH 136-16	DMH 136-16/136-16	136	16	75	163	16	90	271	16	150
DMH 166-16	DMH 166-16/166-16	166	16	92	200	16	110	—	—	—
DMH 202-16	DMH 202-16/202-16	202	16	112	242	16	134	—	—	—
DMH 276-16	DMH 276-16/276-16	276	16	153	—	—	—	—	—	—
DMH 255										
DMH 194-10	DMH 194-10/194-10	194	10	54	233	10	65	387	10	108
DMH 270-10	DMH 270-10/270-10	270	10	75	324	10	90	540	10	150
DMH 332-10	DMH 332-10/332-10	332	10	92	398	10	110	—	—	—
DMH 403-10	DMH 403-10/403-10	403	10	112	484	10	134	—	—	—
DMH 550-10	DMH 550-10/550-10	550	10	153	—	—	—	—	—	—
DMH 257										
DMH 220-10	DMH 220-10/220-10	220	10	28	264	10	34	440	10	56
DMH 440-10	DMH 440-10/440-10	440	10	56	528	10	67	880	10	112
DMH 575-10	DMH 575-10/575-10	575	10	73	690	10	88	1150	10	146
DMH 750-4	DMH 750-4/750-4	750	4	73	900	4	88	1500	4	146
DMH 770-10	DMH 770-10/770-10	770	10	98	924	10	118	—	—	—
DMH 880-10	DMH 880-10/880-10	880	10	112	1056	10	134	—	—	—
DMH 1150-10	DMH 1150-10/1150-10	1150	10	146	—	—	—	—	—	—
DMH 1500-4	DMH 1500-4/1500-4	1500	4	146	—	—	—	—	—	—

* l/h per dosing head; double the capacity for double pumps.

Note

The pump can be operated in the range between 10 % and 100 % of the maximum dosing capacity.

6.4.1 Accuracy

- Dosing flow fluctuation: smaller than $\pm 1\%$
- Linearity deviation: $\pm 1\%$ of the full-scale value (for water with a fully deaerated dosing head).

6.4.2 Inlet pressure and counter-pressure/suction lift

Maximum inlet pressure

Pump type	[bar]
DMH 251	8
DMH 252	8
DMH 253	5
DMH 254	5
DMH 255	0.8
DMH 257	0.8

Minimum counter-pressure at the discharge valve of the pump

Pump type	[bar]
DMH 251	2
DMH 252	2
DMH 253	2
DMH 254	2
DMH 255	2
DMH 257	2

A positive pressure difference of at least 2 bar is required between the suction valve and the discharge valve in order for the dosing pump to operate correctly.

Note

If the total counter-pressure (at the dosing point) and geodetic height difference between the suction valve and the dosing point is less than 2 bar (20 m WC), a pressure-loading valve must be installed immediately before the dosing point.

Maximum counter-pressure*

Pump type		p max. [bar]
Single pump	Double pump	
DMH 251		
DMH 2.4-10	DMH 2.4-10/2.4-10	10
DMH 5-10	DMH 5-10/5-10	10
DMH 13-10	DMH 13-10/13-10	10
DMH 19-10	DMH 19-10/19-10	10
DMH 24-10	DMH 24-10/24-10	10
DMH 2.3-16	DMH 2.3-16/2.3-16	16
DMH 4.9-16	DMH 4.9-16/4.9-16	16
DMH 12-16	DMH 12-16/12-16	16
DMH 18-16	DMH 18-16/18-16	16
DMH 23-16	DMH 23-16/23-16	16
DMH 2.2-25	DMH 2.2-25/2.2-25	25
DMH 4.5-25	DMH 4.5-25/4.5-25	25
DMH 11-25	DMH 11-25/11-25	25
DMH 17-25	DMH 17-25/17-25	25
DMH 21-25	DMH 21-25/21-25	25
DMH 252		
DMH 11-10	DMH 11-10/11-10	10
DMH 24-10	DMH 24-10/24-10	10
DMH 37-10	DMH 37-10/37-10	10
DMH 46-10	DMH 46-10/46-10	10
DMH 10-16	DMH 10-16/10-16	16
DMH 23-16	DMH 23-16/23-16	16
DMH 36-16	DMH 36-16/36-16	16
DMH 45-16	DMH 45-16/45-16	16
DMH 54-16	DMH 54-16/54-16	16
DMH 253		
DMH 21-10	DMH 21-10/21-10	10
DMH 43-10	DMH 43-10/43-10	10
DMH 67-10	DMH 67-10/67-10	10
DMH 83-10	DMH 83-10/83-10	10
DMH 100-10	DMH 100-10/100-10	10
DMH 254		
DMH 50-10	DMH 50-10/50-10	10
DMH 102-10	DMH 102-10/102-10	10
DMH 143-10	DMH 143-10/143-10	10
DMH 175-10	DMH 175-10/175-10	10
DMH 213-10	DMH 213-10/213-10	10
DMH 291-10	DMH 291-10/291-10	10
DMH 46-16	DMH 46-16/46-16	16
DMH 97-16	DMH 97-16/97-16	16
DMH 136-16	DMH 136-16/136-16	16
DMH 166-16	DMH 166-16/166-16	16
DMH 202-16	DMH 202-16/202-16	16
DMH 276-16	DMH 276-16/276-16	16
DMH 255		
DMH 194-10	DMH 194-10/194-10	10
DMH 270-10	DMH 270-10/270-10	10
DMH 332-10	DMH 332-10/332-10	10
DMH 403-10	DMH 403-10/403-10	10
DMH 550-10	DMH 550-10/550-10	10

Pump type		p max. [bar]
Single pump	Double pump	
DMH 257		
DMH 220-10	DMH 220-10/220-10	10
DMH 440-10	DMH 440-10/440-10	10
DMH 575-10	DMH 575-10/575-10	10
DMH 750-4	DMH 750-4/750-4	10
DMH 770-10	DMH 770-10/770-10	10
DMH 880-10	DMH 880-10/880-10	10
DMH 1150-10	DMH 1150-10/1150-10	4
DMH 1500-4	DMH 1500-4/1500-4	4

* Observe the maximum permissible temperatures.

Maximum suction lift* (continuous operation) for media with a viscosity similar to water

Pump type	Maximum suction lift [m WC]
DMH 251	1
DMH 252	1
DMH 253	
DMH 21-10	1
DMH 43-10	1
DMH 67-10	1
DMH 83-10	1
DMH 100-10	Flooded suction
DMH 254	
DMH 50-10	1
DMH 102-10	1
DMH 143-10	1
DMH 175-10	1
DMH 213-10	1
DMH 291-10	Flooded suction
DMH 46-16	1
DMH 97-16	1
DMH 136-16	1
DMH 166-16	1
DMH 202-16	1
DMH 276-16	Flooded suction
DMH 255	Flooded suction
DMH 257	
DMH 220-10	1
DMH 440-10	1
DMH 575-10	1
DMH 770-10	1
DMH 880-10	Flooded suction
DMH 1150-10	Flooded suction
DMH 750-4	Flooded suction
DMH 1500-4	Flooded suction

* Applies to a filled dosing head.

Maximum suction lift (continuous operation) for media with maximum permissible viscosity

Pump type	Maximum suction lift [m WC]
DMH 251	Flooded suction
DMH 252	Flooded suction
DMH 253	Flooded suction
DMH 254	Flooded suction
DMH 255	Flooded suction
DMH 257	Flooded suction

6.5 Sound pressure level

Pump type	
DMH 251	55 ± 5 dB(A)*
DMH 252	55 ± 5 dB(A)*
DMH 253	65 ± 5 dB(A)*
DMH 254	65 ± 5 dB(A)*
DMH 255	75 ± 5 dB(A)*
DMH 257	75 ± 5 dB(A)*

* Testing according to DIN 45635-01-KL3.

6.6 Electrical data

6.6.1 Enclosure class

The enclosure class depends on the motor variant selected, see motor nameplate.

The specified enclosure class can only be ensured if the power supply cable is connected with the same degree of protection.

Pumps with electronics: The enclosure class is only met if the sockets are protected! The data regarding the enclosure class applies to pumps with correctly inserted plugs or screwed-on caps.

6.6.2 Motor

Version: see motor and pump nameplates.

6.7 AR control unit

Functions of pumps with electronics:

- "Continuous operation" button for function test and dosing head deaeration
- memory function (stores a maximum of 65,000 pulses)
- two-stage tank-empty signal (e.g. via Grundfos tank empty sensor)
- stroke signal/pre-empty signal (adjustable), e.g. as a feedback to the control room
- dosing controller function (only with sensor – optional)
- diaphragm leakage detection (only with sensor – optional)
- access-code-protected settings
- remote on/off
- Hall sensor
- operating hours counter
- motor monitoring.

Operating modes:

- manual
Stroke frequency: manually adjustable between zero and maximum
- contact signal control
Multiplier (1:n) and divisor (n:1)
- current signal control 0-20 mA/4-20 mA
Adjustment of stroke frequency proportional to the current signal. Weighting of current input.

6.7.1 Inputs and outputs

Inputs

Contact signal	Maximum load: 12 V, 5 mA
Current 0-20 mA	Maximum load: 22 Ω
Remote on/off	Maximum load: 12 V, 5 mA
Two-stage tank-empty signal	Maximum load: 12 V, 5 mA
Dosing controller and diaphragm leakage sensor	

Outputs

Current 0-20 mA	Maximum load: 350 Ω
Error signal	Maximum ohmic load: 50 VDC/75 VAC, 0.5 A
Stroke signal	Contact time/stroke: 200 ms
Pre-empty signal	Maximum ohmic load: 50 VDC/75 VAC, 0.5 A

AR control unit factory settings

- Inputs and outputs: NO (normally open)
or
- inputs and outputs: NC (normally closed).

6.8 Power supply

Power supply for AC voltage

Rated voltage	Permissible deviation from rated value
230 / 400 V	± 10 %
240 / 415 V	± 10 %
115 V	± 10 %

Maximum permissible mains impedance

(0.084 + j 0.084) Ohm (testing according to DIN EN 61000-3-11). These details apply to 50 Hz.

6.9 Ambient and operating conditions

- Permissible ambient temperature: 0 °C to +40 °C (for an installation height up to 1000 m above sea level).
- Permissible storage temperature: -20 °C to +50 °C.
- Permissible air humidity: max. relative humidity: 70 % at +40 °C, 90 % at +35 °C.

Caution

***The installation site must be under cover!
Do not install outdoors!***

6.10 Dosing medium

Note

In the event of questions regarding the material resistance and suitability of the pump for specific dosing media, please contact Grundfos.

The dosing medium must have the following basic characteristics for the standard pumps:

- liquid
- non-abrasive
The dosing of abrasive media is possible with certain versions, on request.
- non-inflammable
The dosing of inflammable media is possible with certain versions of explosion-proof pumps, in accordance with ATEX.

Maximum permissible viscosity at operating temperature*

Applies to:

- Newtonian liquids
- non-degassing media
- media without suspended matter
- media with a density similar to water.

Note *Note that the viscosity increases with decreasing temperature!*

Pump type	Up to stroke rate 63 [n/min]	Stroke rate 64-120 [n/min]	From stroke rate 121 [n/min]
	Maximum viscosity* [mPa s]		
DMH 251	300	100	50
DMH 252	300	100	50
DMH 253	300	100	10
DMH 254	300	100	5
DMH 255	200	100	5
DMH 257	200	50	5

* The stated values are approximate values and apply to the standard pumps.

Permissible media temperature

Dosing head material	Min. media temperature	Max. media temperature	
		p < 10 bar	p < 16 bar
	[°C]	[°C]	[°C]
PVC	0	40	20
Stainless steel, DIN 1.4571*	-10	100	100
Stainless steel, DIN 2.4610*	-10	100	100
PP	0	40	20
PVDF**	-10	60	20

* For SIP/CIP applications: A temperature of 145 °C at a counter-pressure of max. 2 bar is permitted for a short period (15 minutes).

** At 70 °C, the maximum counter-pressure is 9 bar.

**Warning**

Observe the chemical manufacturer's safety instructions when handling chemicals!

**The dosing medium must be in liquid form!
Observe the freezing and boiling points of the dosing medium!**

The resistance of the parts that come into contact with the media depends on the media, media temperature and operating pressure.

Caution

Ensure that parts in contact with the media are chemically resistant to the dosing medium under operating conditions!

Make sure that the pump is suitable for the actual dosing medium!

7. Transport and storage

Do not throw or drop the pump.

Caution **Do not use the protective packaging as transport packaging.**

7.1 Delivery

The DMH 25x dosing pumps are supplied in different packaging, depending on pump type and the overall delivery. For transport and intermediate storage, use the correct packaging to protect the pump against damage.

7.2 Unpacking

Retain the packaging for future storage or return, or dispose of the packaging in accordance with local regulations.

7.3 Intermediate storage

- Permissible storage temperature: -20 °C to +50 °C.
- Permissible air humidity: max. relative humidity: 70 % at +40 °C, 90 % at +35 °C.

7.4 Return

The pump must be thoroughly cleaned before it is returned or stored. It is essential that there are no traces of toxic or hazardous media remaining on the pump. Drain the oil from the drive mechanism and package the pump correctly.

Caution **Grundfos accepts no liability for damage caused by incorrect transportation, missing or unsuitable packaging of the pump, residual media or leaking oil!**

Before returning the pump to Grundfos Water Treatment for service, the **safety declaration** at the end of these instructions must be filled in by authorised personnel and attached to the pump in a visible position.

Caution **If a pump has been used for a medium which is injurious to health or toxic, the pump will be classified as contaminated.**

If Grundfos Water Treatment is requested to service the pump, it must be ensured that the pump is free from substances that can be injurious to health or toxic. If the pump has been used for such substances, the pump must be cleaned before it is returned.

If proper cleaning is not possible, all relevant information about the chemical must be provided.

If the above is not fulfilled, Grundfos Water Treatment can refuse to accept the pump for service. Possible costs of returning the pump are paid by the customer.

The safety declaration can be found at the end of these instructions.

Caution **The replacement of the power supply cable must be carried out by an authorised Grundfos service workshop.**

8. Product description and accessories

8.1 General description

The DMH 25x are oscillatory positive-displacement pumps with hydraulic diaphragm control. The operation procedure of the dosing pump is shown in the sectional drawing. See fig. 1.

The rotational movement of the drive motor (1p) is converted via the worm gearing (2p) and eccentric (3p) into the oscillatory suction and stroke movement of the piston (6p). The piston has a hollow bore and a row of radial control holes, which provide a hydraulic connection between the drive area and the piston stroke area. The sliding plug (5p) envelops the holes during the stroke and seals the stroke area from the drive area.

The hydraulic excursion of the solid PTFE diaphragm (Q) displaces an equivalent volume of dosing medium from the dosing head (2) into the discharge line. With the suction stroke, the piston creates a low pressure, which propagates in the dosing head, the ball valve (3b) on the dosing side closes and the dosing medium flows through the suction valve (3a) into the dosing head.

The stroke volume size is solely determined by the position of the sliding plug. The active stroke length and corresponding average dosing flow can therefore be changed continuously and linearly from 10 % to 100 % using the stroke-length adjustment knob and Nonius (L).

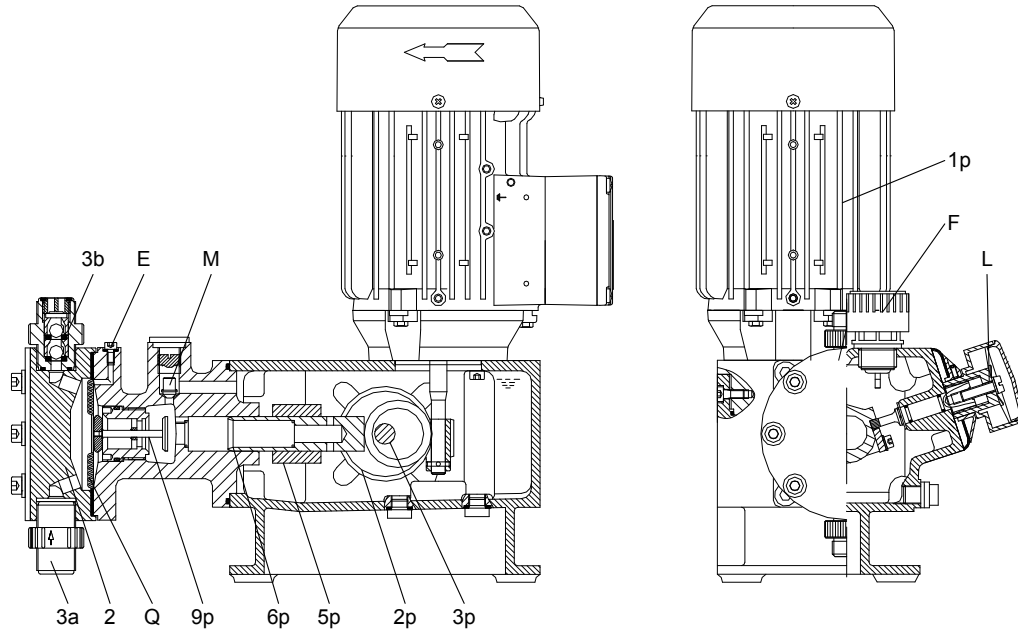

Fig. 2 DMH 251, 252

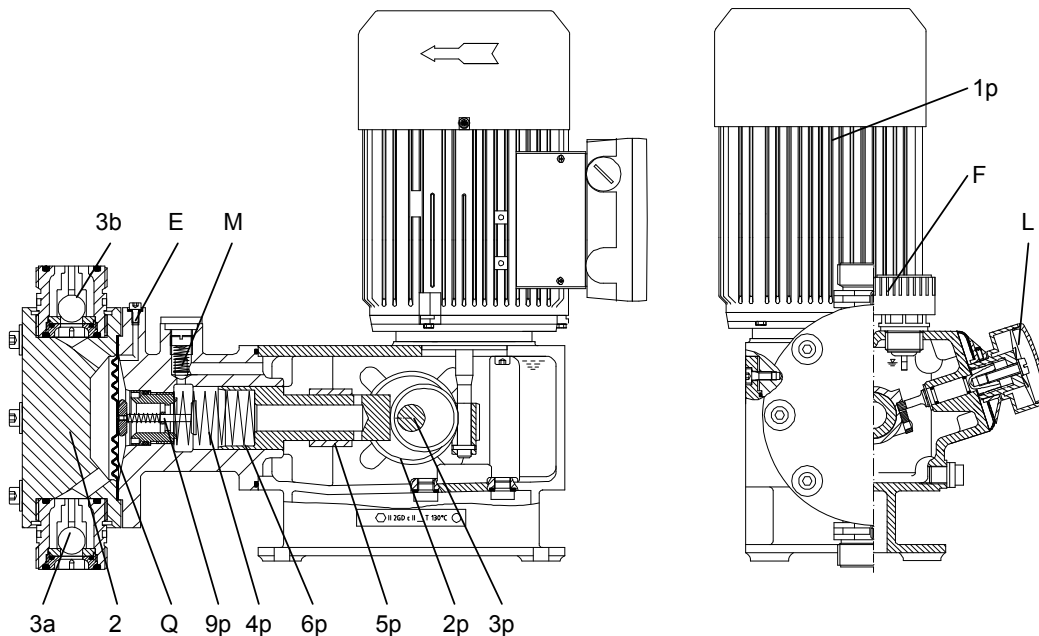

Fig. 3 DMH 253

TM03 6448 4506

TM03 6449 4506

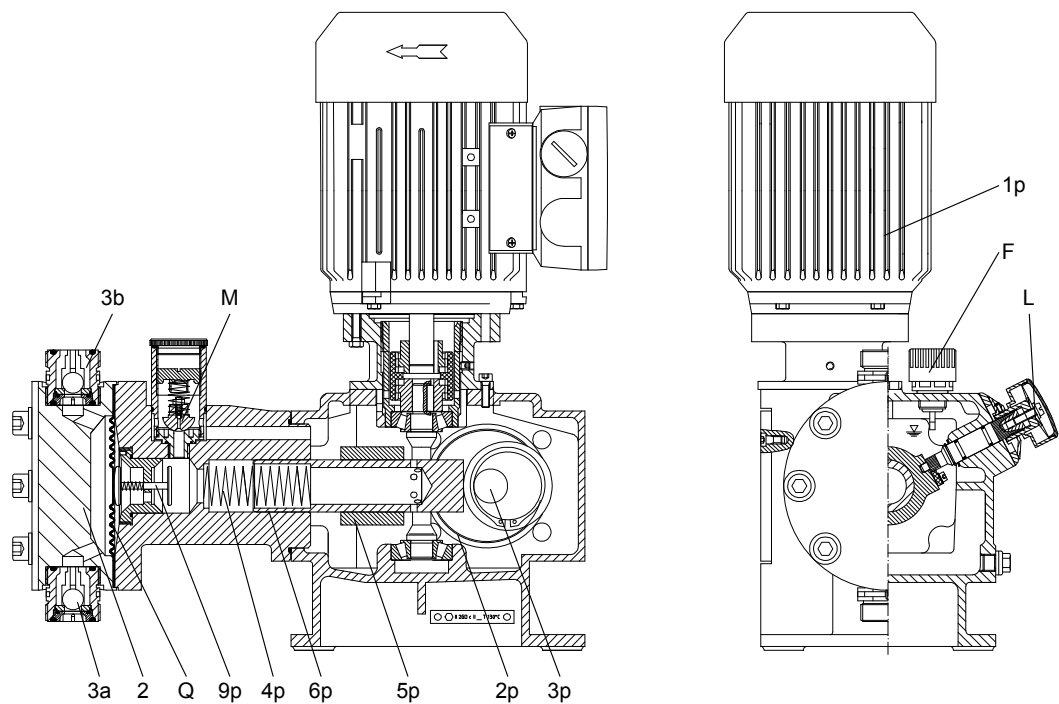

Fig. 4 DMH 254

TM03 6450 4506

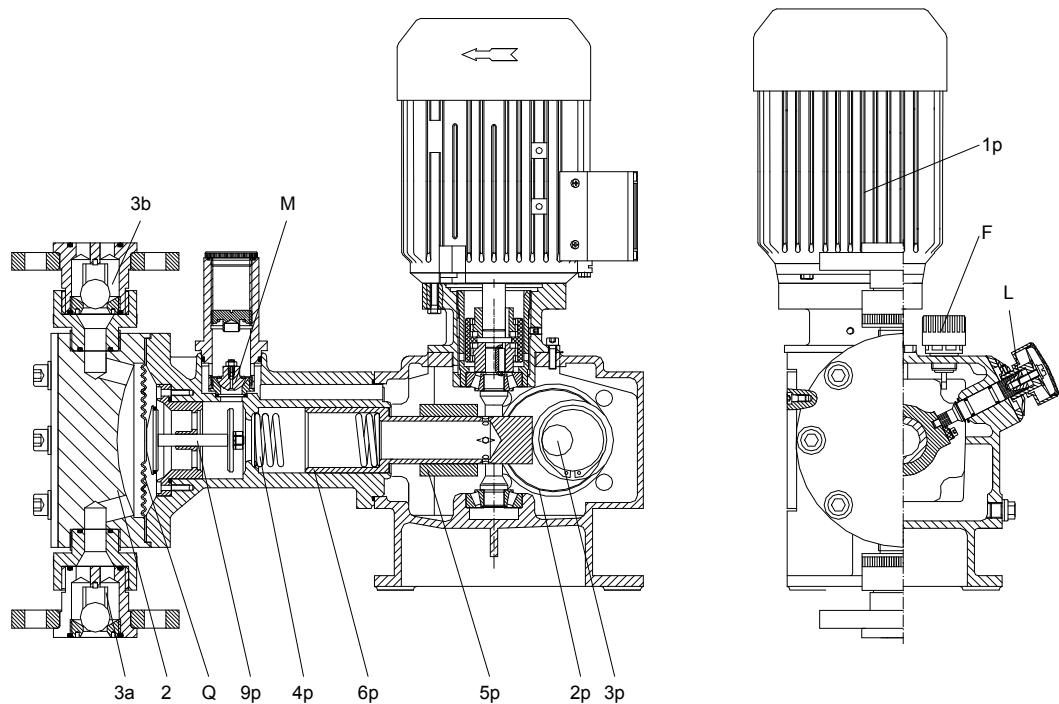

Fig. 5 DMH 255

TM03 6451 4506

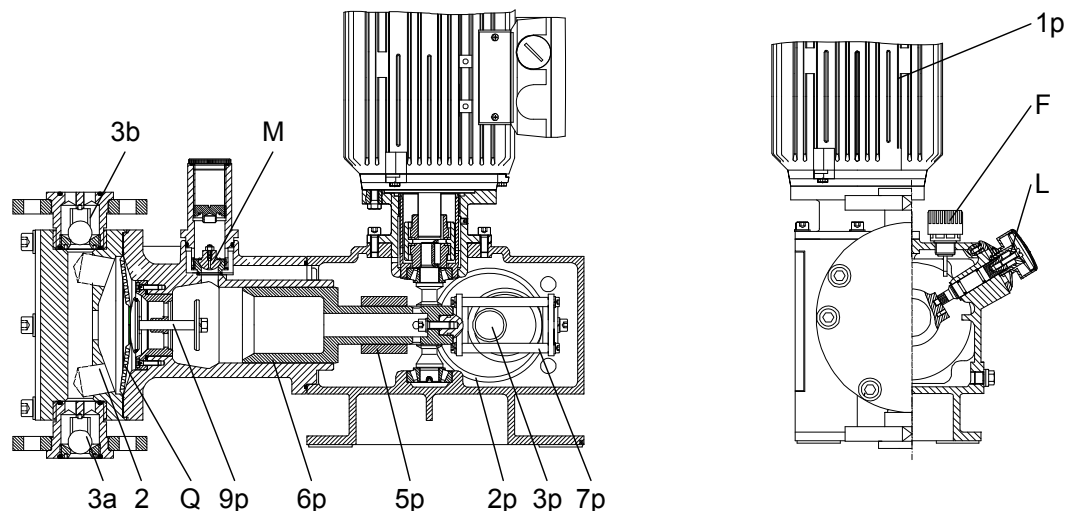

Fig. 6 DMH 257

Pos.	Components
1p	Motor
2p	Worm gearing
3p	Eccentric
4p	Recuperating spring (not with drive size 3)
5p	Sliding plug
6p	Piston
7p	Crank
M	Combined overpressure and degassing valve
E	Degassing valve
9p	Diaphragm protection system (AMS)
Q	Dosing diaphragm
2	Dosing head
3a	Suction valve
3b	Discharge valve
L	Stroke-length adjustment knob
F	Oil-filling screw with dipstick

8.1.1 Combined overpressure and degassing valve

The combined overpressure and degassing valve (M) opens if there is an excessive pressure build-up in the dosing system and provokes the constant degassing of the hydraulic medium.

8.1.2 Diaphragm protection system AMS

The diaphragm protection system AMS (9p) has a keypad, which is connected to the dosing diaphragm. The dosing diaphragm oscillates freely in the dosing head and cannot be overstretched due to a fault in the dosing system since the diaphragm protection valve closes if such a fault occurs.

8.1.3 Double-diaphragm system/diaphragm leakage detection (optional)

General

The piston diaphragm and high-tech dosing pumps with drift-free diaphragm leakage detection are equipped with the following:

- dosing head with PTFE double-diaphragm system
- ball non-return valve with built-in contact pressure gauge.

Double-diaphragm system

Dosing pumps with a double-diaphragm system with no diaphragm leakage detection have no pressure gauge. In this case the ball non-return valve is fitted with a locking unit. The valve, however, can be retrofitted with a contact pressure gauge.

Ball non-return valve

In order for the diaphragm leakage detection to work and to protect the diaphragms, the gap must be fully deaerated. Dosing heads with a double diaphragm are equipped with a ball non-return valve (T) to prevent air from flowing back during the filling and deaeration process (2u).

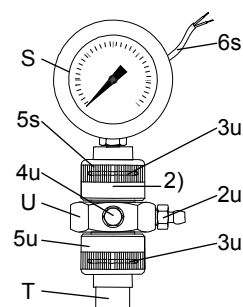

Fig. 7 Contact pressure gauge

Pos.	Components
S	Contact pressure gauge
T	Ball non-return valve
U	Connection piece

2) For dosing heads with a double diaphragm with no contact pressure gauge (no diaphragm leakage detection), a locking unit is fitted instead of the contact pressure gauge.

TM03 6452 4506

TM03 6453 4506

Functional principle of diaphragm leakage detection

The non-return valve and the gap between the diaphragms are factory-filled with a separating agent (paraffin oil). They are set in such a way during start-up on the test stand that there is always a hydraulically separated equilibrium between the valve and diaphragm gap (the pressure gauge indicates "0" when the pump is running and when it is stopped).

If one of these diaphragms breaks, the dosing or hydraulic medium penetrates into the gap between the diaphragms and, when the ball is removed, into the valve. The system pressure is therefore impinged on the valve and the contact pressure gauge is activated. Depending on the design of the system, the electrically isolated reed contact can trigger an alarm device or the pump can be switched off.

The contact is triggered at the preset pressure as is shown in the table below:

Description/use	Set pressure [bar]
For pumps up to 10 bar Pressure gauge 0 to 10 bar	1.5
For pumps up to 10 bar Explosion-proof pressure gauge 0 to 10 bar	1.5
For pumps 16 to 100 bar Pressure gauge 0 to 100 bar	10
For pumps 16 to 100 bar Explosion-proof pressure gauge 0 to 100 bar	10



Warning

The contact pressure gauge (Ex) in explosion-proof version with switch amplifier should be used if the pump is fitted with an explosion-proof motor.

8.2 Dimensional sketches

8.2.1 DMH 251, 252, 253

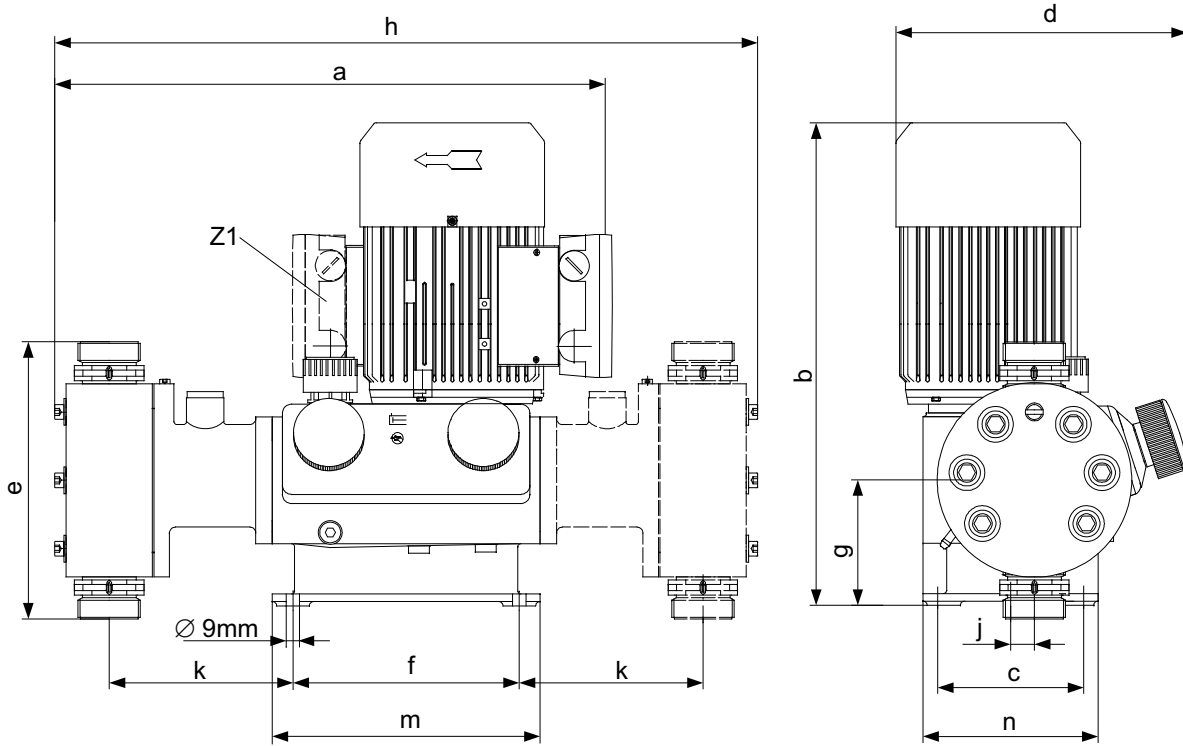

Fig. 8 DMH 251, 252, 253

Pos.	Description
Z1	For double pump, motor turned by 180 °

Pump type	a	b	c	d	e	f	g	h	j	k	n	m
DMH 251	345	336	98	192	160	152	86	432	16	116	118	180
DMH 252	345	336	98	192	160	152	86	432	16	116	118	180
DMH 253	368	336	98	192	179	152	86	472	13	124	118	180

Measurements in mm.

TM03 6454 1612

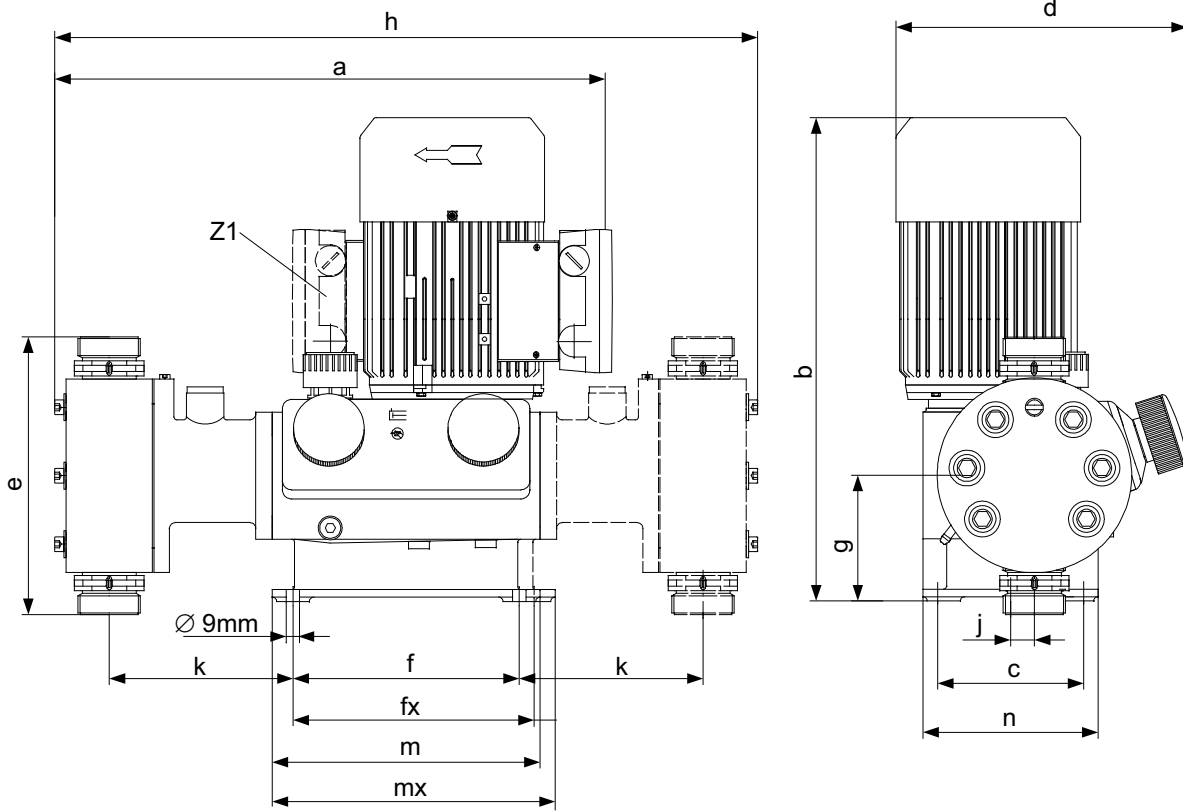

Fig. 9 DMH 254, 255, 257

TN03 6455 1612

Pos.	Description
Z1	For double pump, motor turned by 180 °
fx, mx	For double pumps

Pump type	a	b	c	d	e	f	fx	g	h	j	k	n	m	mx
DMH 254	436	492	156	252	207	185	260	126	718	10	185	180	225	300
DMH 255	510	492	156	254	228	185	260	126	869	10	253	180	225	300
DMH 257	589	553	170	274	280	241	333	129	980	25	262	195	290	382

Measurements in mm.

8.3 Weight

Pump type	Dosing head material	Weight [kg]	
		Single pump	Double pump
DMH 251	PVC, PP, PVDF	11	13
	Stainless steel 1.4571, 2.4610	13	17
DMH 252	PVC, PP, PVDF	11	13
	Stainless steel 1.4571, 2.4610	13	17
DMH 253	PVC, PP, PVDF	12	17
	Stainless steel 1.4571, 2.4610	14	21
DMH 254	PVC, PP, PVDF	27	32
	Stainless steel 1.4571, 2.4610	32	42
DMH 255	PVC, PP, PVDF	55	63
	Stainless steel 1.4571, 2.4610	65	83
DMH 257	PVC, PP, PVDF	56	88
	Stainless steel 1.4571, 2.4610	68	112

8.4 Stroke volume

Pump type	Stroke volume [cm ³]			
	4 bar	10 bar	16 bar	25 bar
DMH 251	—	3.5	3.1	2.9
DMH 252	—	6.4	6.3	—
DMH 253	—	11.3	—	—
DMH 254	—	31.6	30	—
DMH 255	—	60	—	—
DMH 257	171	131	—	—

8.5 Materials

Pump housing material

- Pump housing: Al 226.

AR control unit enclosure

- Upper part of enclosure: PPO blend
- Lower part of enclosure: aluminium.



Warning

Observe the chemical manufacturer's safety instructions when handling chemicals!

Make sure that the pump is suitable for the actual dosing medium!

The resistance of the parts that come into contact with the media depends on the media, media temperature and operating pressure.

Caution

Ensure that parts in contact with the media are chemically resistant to the dosing medium under operating conditions!

Note

Further information on resistance with regard to the media, media temperature and operating pressure is available on request.

8.6 Data of contact pressure gauge for diaphragm leakage detection (optional)

The contact pressure gauge has a reed switch with electrically isolated contact output, maximum switching power 10 W for DC current or 10 VA for AC current. The maximum switching voltage is 100 V, maximum switching current 0.5 A.

The switching function is set up as an NC contact, i.e. if the diaphragm breaks, the current circuit is interrupted.

The pressure gauge has a 2-metre cable.

9. Installation

9.1 General information on installation



Warning

Observe the specifications for the installation location and range of applications described in section 6. Technical data.



Warning

Faults, incorrect operation or faults on the pump or system can, for example, lead to excessive or insufficient dosing, or the permissible pressure may be exceeded. Consequential faults or damage must be evaluated by the operator and appropriate precautions must be taken to avoid them!



Warning

Risk of hot surfaces!

Pumps with AC motors may become hot. Allow a minimum space of 100 mm to the fan cover!

A positive pressure difference of at least 2 bar is required between the suction valve and the discharge valve in order for the dosing pump to operate correctly.

Note

If the total counter-pressure (at the dosing point) and geodetic height difference between the suction valve and the dosing point is less than 2 bar (20 m WC), a pressure-loading valve must be installed immediately before the dosing point.

9.2 Installation location

9.2.1 Space required for operation and maintenance

Note

The pump must be installed in a position where it is easily accessible during operation and maintenance work.

Maintenance work on the dosing head and the valves must be carried out regularly.

- Provide sufficient space for removing the dosing head and the valves.

9.2.2 Permissible ambient influences

- Permissible ambient temperature: 0 °C to +40 °C (for an installation height up to 1000 m above sea level).
- Permissible air humidity: max. relative humidity: 70 % at +40 °C, 90 % at +35 °C.

Note

The installation site must be under cover! Do not install outdoors!

9.2.3 Mounting surface

The pump must be mounted on a flat surface.

9.3 Mounting

- Mount the pump on a console or pump foundation using four screws.

Note

The flow must run in the opposite direction to gravity!

9.4 Approximate values when using pulsation dampers

Risk of damage to the system!

It is always recommended to use pulsation dampers for large high-speed pumps!

In particular for pump types with a flow rate above 1000 l/h (DMH 257), suction and discharge pulsation dampers should be used directly at the pump suction and discharge ports of the pump. The size of the suction and discharge lines should be adjusted accordingly.

Caution

Since the pulsation is influenced by many factors, a system-specific calculation is essential. Request a calculation from our calculation program.

The table below indicates the approximate values and the suction line length for which suction pulsation dampers are required. The values apply to 50 Hz operation when water or similar liquids are dosed.

Pump type	Stroke rate [n/min]	Nominal width of suction line	Maximum length of suction line [m]
DMH 251			
DMH 2.4-10	14	DN 8	8
DMH 5-10	29	DN 8	8
DMH 13-10	63	DN 8	3
DMH 19-10	96	DN 8	1.5
DMH 24-10	120	DN 8	1
DMH 2.3-16	14	DN 8	8
DMH 4.9-16	29	DN 8	8
DMH 12-16	63	DN 8	3
DMH 18-16	96	DN 8	1.5
DMH 23-16	120	DN 8	1
DMH 2.2-25	14	DN 8	8
DMH 4.5-25	29	DN 8	8
DMH 11-25	63	DN 8	3
DMH 17-25	96	DN 8	1.5
DMH 21-25	120	DN 8	1
DMH 252			
DMH 11-10	29	DN 8	8
DMH 24-10	63	DN 8	2
DMH 37-10	96	DN 8	1
DMH 46-10	120	DN 8	1
DMH 10-16	29	DN 8	8
DMH 23-16	63	DN 8	2
DMH 36-16	96	DN 8	1
DMH 45-16	120	DN 8	1
DMH 54-16	144	DN 8	1
DMH 253			
DMH 21-10	29	DN 20	8
DMH 43-10	63	DN 20	8
DMH 67-10	96	DN 20	6
DMH 83-10	120	DN 20	4
DMH 100-10	144	DN 20	3

Pump type	Stroke rate [n/min]	Nominal width of suction line	Maximum length of suction line [m]
DMH 254			
DMH 50-10	26	DN 20	8
DMH 102-10	54	DN 20	8
DMH 143-10	75	DN 20	5
DMH 175-10	92	DN 20	3
DMH 213-10	112	DN 20	1.5
DMH 291-10	153	DN 20	1
DMH 46-16	26	DN 20	8
DMH 97-16	54	DN 20	8
DMH 136-16	75	DN 20	5
DMH 166-16	92	DN 20	3
DMH 202-16	112	DN 20	1.5
DMH 276-16	153	DN 20	1
DMH 255			
DMH 194-10	54	DN 20	5
DMH 270-10	75	DN 20	3
DMH 332-10	92	DN 20	1.5
DMH 403-10	112	DN 20	1
DMH 550-10	153	DN 20	1.5
DMH 257			
DMH 220-10	28	DN 32	4.5
DMH 440-10	56	DN 32	4.5
DMH 575-10	73	DN 32	3
DMH 750-4	73	DN 32	1.5
DMH 770-10	98	DN 32	1.5
DMH 880-10	112	DN 32	1
DMH 1150-10	146	DN 32	0.5
DMH 1500-4	146	DN 32	0.5

9.5 Optimum installation

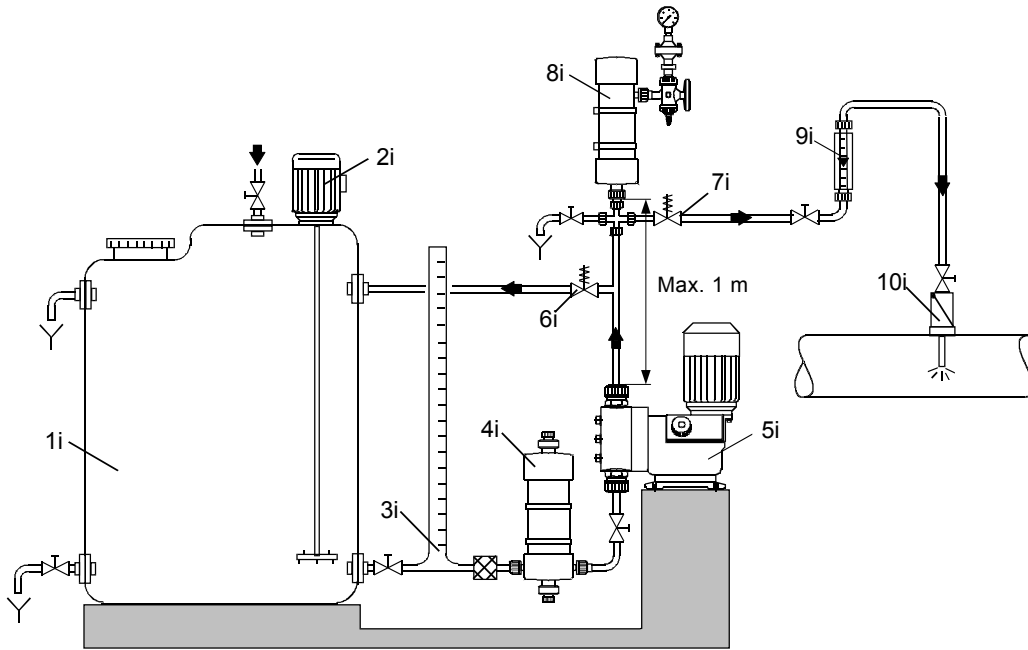

Fig. 10 Example of optimum installation

Pos.	Components
1i	Dosing tank
2i	Electric agitator
3i	Extraction device
4i	Suction pulsation damper
5i	Dosing pump
6i	Relief valve
7i	Pressure-loading valve
8i	Pulsation damper
9i	Measuring glass
10i	Injection unit

9.6 Installation tips

- For easy deaeration of the dosing head, install a ball valve (11i) with bypass line (back to the dosing tank) immediately after the discharge valve.
- In the case of long discharge lines, install a non-return valve (12i) in the discharge line.

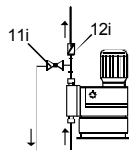

Fig. 11 Installation with ball valve and non-return valve

- When installing the suction line, observe the following:
 - Keep the suction line as short as possible. Prevent it from becoming tangled.
 - If necessary, use swept bends instead of elbows.
 - Always route the suction line up towards the suction valve.
 - Avoid loops which may cause air bubbles.

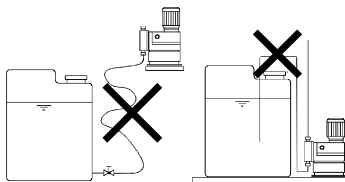

Fig. 12 Installation of suction line

- For non-degassing media with a viscosity similar to water, the pump can be mounted on the tank (observe the maximum suction lift).
- Flooded suction preferred.
- For media with a tendency to sedimentation, install the suction line with filter (13i) so that the suction valve remains a few millimetres above the possible level of sedimentation.

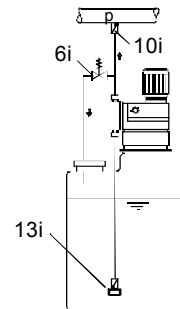

Fig. 13 Tank installation

- Note for suction-side installation: Depending on the dosing flow and the line length, it may be necessary to install a properly sized pulsation damper (4i) immediately before the pump suction valve.

Note Observe section 9.4 Approximate values when using pulsation dampers and, if necessary, request a system-specific calculation from our calculation program.

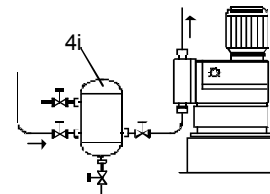

Fig. 14 Installation with suction-side pulsation damper

- Note for discharge-side installation: Depending on the dosing flow and the line length, it may be necessary to install a properly sized pulsation damper (4i) on the discharge side.

TM03 6296 4506

TM03 6299 4506

TM03 6297 4506

TM03 6298 4506

TM03 6300 4506

Note

To protect the system, use pulsation dampers (8i) for rigid piping longer than 2 metres and tubing longer than 3 metres, depending on pump type and size.

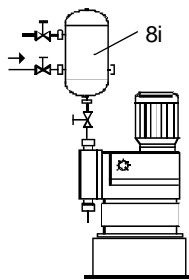

Fig. 15 Installation with discharge-side pulsation damper

Risk of damage to the system!
It is always recommended to use pulsation dampers for large high-speed pumps!
Caution Since the pulsation is influenced by many factors, a system-specific calculation is essential. Request a calculation from our calculation program.

- For degassing and viscous media: flooded suction.
- Install a filter in the suction line to prevent the valves from becoming choked.
- To protect the dosing pump and the discharge line against excessive pressure build-up, install a relief valve (6i) in the discharge line.

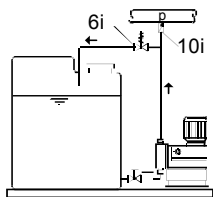

Fig. 16 Installation with relief valve

With open outflow of the dosing medium or a counter-pressure below 2 bar

- Install a pressure-loading valve (7i) immediately before the outlet or the injection unit.
- A positive pressure difference of at least 2 bar must be ensured between the counter-pressure at the injection point and the pressure of the dosing medium at the pump suction valve.
- If this cannot be ensured, install a pressure-loading valve (7i) in the discharge line.

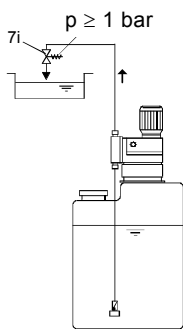

Fig. 17 Installation with pressure-loading valve

- To avoid the siphon effect, install a pressure-loading valve (7i) in the discharge line and, if necessary, a solenoid valve (14i) in the suction line.

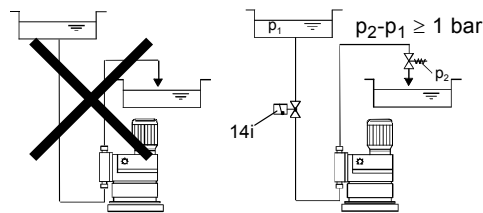

Fig. 18 Installation to avoid the siphon effect

9.7 Tube / pipe lines

9.7.1 General

Warning

To protect the dosing system against excessive pressure build-up, install a relief valve in the discharge line.

Only use the prescribed line types!

All lines must be free from strain!

Avoid loops and buckles in the tubes!

Keep the suction line as short as possible to avoid cavitation!

If necessary, use swept bends instead of elbows.

Observe the chemical manufacturer's safety instructions when handling chemicals!

Make sure that the pump is suitable for the actual dosing medium!

The flow must run in the opposite direction to gravity!

The resistance of the parts that come into contact with the media depends on the media, media temperature and operating pressure.

Ensure that parts in contact with the media are chemically resistant to the dosing medium under operating conditions!



Caution

9.8 Connecting the suction and discharge lines



Warning

All lines must be free from strain!

Only use the prescribed line types!

- Connect the suction line to the suction valve.
 - Install the suction line in the tank so that the foot valve remains 5 to 10 mm above the bottom of the tank or the possible level of sedimentation.
- Connect the discharge line to the discharge valve.

Connection of hose lines

- Push the hose firmly on the connection nipple and, depending on the connection, secure using a connection counterpart or hose clip.
- Fit the gasket.
- Screw the hose on the valve using the union nut.

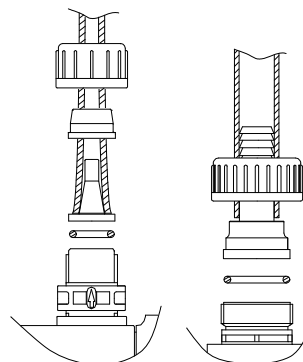

Fig. 19 Connection of hose lines

TM03 6301 4506

TM03 6302 4506

TM03 6303 4506

TM03 6304 4506

TM03 6456 4506

Connection of DN 20 pipe lines

- Depending on the pipe material and connection, glue the pipe (PVC), weld it (PP, PVDF or stainless steel) or press it in (stainless steel).
- Fit the gasket.
- Screw the pipe on the valve using the union nut.

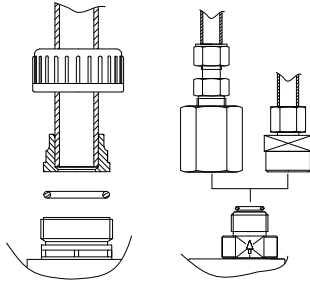

Fig. 20 Connection of DN 20 pipe lines

Connection of DN 32 pipe lines

- Depending on the pipe material, fit the pipe to the welding neck flange and weld it (stainless steel) or insert it into the headed bush and weld it (PP, PVDF).

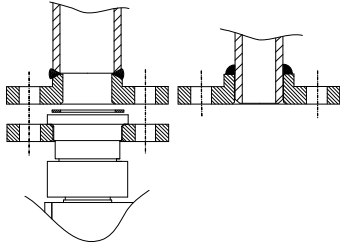

Fig. 21 Connection of DN 32 pipe lines

9.8.1 Connecting a liquid-heated dosing head (optional)

As an option, liquid-heated dosing heads are available in stainless steel.

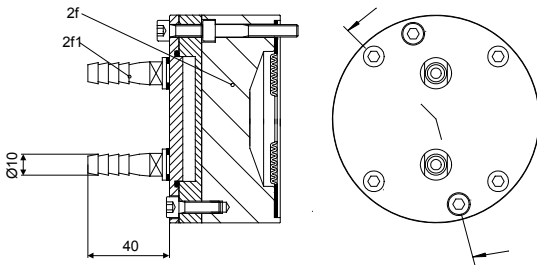

Fig. 22 Liquid-heated dosing head

Pos.	Components
2f	Dosing head, liquid-heated
2f1	Hose nipple, DN 10 connection

Required characteristics of heating liquid:

- The heating liquid must not chemically attack stainless steel.
- Maximum permissible pressure: $p_{max.} = 3 \text{ bar}$.
- Maximum permissible temperature: $t_{max.} = 100 \text{ }^\circ\text{C}$.

10. Electrical connections

Make sure that the pump is suitable for the electricity supply on which it will be used.

Warning



Electrical connections must only be carried out by qualified personnel!

Disconnect the power supply before connecting the power supply cable and the relay contacts!

Observe the local safety regulations!

The pump housing must only be opened by personnel authorised by Grundfos!

Protect the cable connections and plugs against corrosion and humidity.

Only remove the protective caps from the sockets that are being used.

10.1 Electric servomotor (optional)

To connect the servomotor to the power supply, see the installation and operating instructions for the servomotor.

10.2 Electronic preselection counter (optional)

To connect the preselection counter to the power supply, see the installation and operating instructions for the counter.

10.3 Electrically heated dosing head (optional)

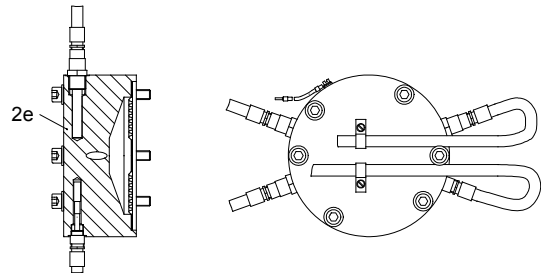

Fig. 23 Electrically heated dosing head

Pos.	Component
2e	Dosing head, electrically heated

- To connect the temperature controller to the power supply, see the installation and operating instructions for the electric temperature controller.

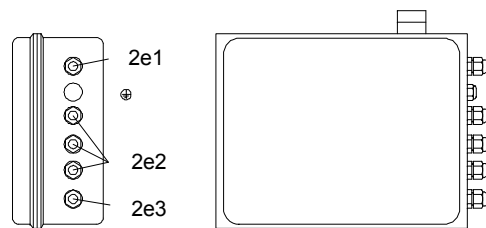

Fig. 24 Temperature controller

Pos.	Connections
2e1	Sensor
2e2	Heating
2e3	Power supply

10.4 Diaphragm controller (optional)



Warning

Explosion-proof pumps with diaphragm leakage detection are fitted with a contact pressure gauge in explosion-proof version.

The pressure gauge must be earthed.

Connecting the earth cable (4u), see fig. 25.

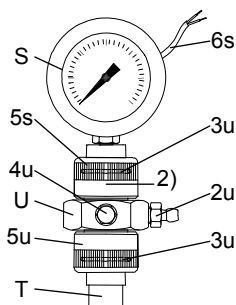

TM03 6453 4506

Fig. 25 Diaphragm controller

Pos.	Components
S	Contact pressure gauge
5s	Union nut
6s	Contact output
T	Ball non-return valve
U	Connection piece
2u	Deaeration screw
3u	O-rings
4u	Connection for earth cable
5u	Union nut
	* 2) or locking unit (instead of contact pressure gauge and its connection)

10.5 Connecting the power supply cable



Warning

Disconnect the power supply before connecting the power supply cable!

Before connecting the power supply cable, check that the rated voltage stated on the pump nameplate corresponds to the local conditions! Do not make any changes to the power supply cable or plug!

Caution

The assignment between the plug-and-socket connection and the pump must be labelled clearly (e.g. by labelling the socket outlet).

Caution

The pump can be automatically started by connecting the power supply!

- Do not switch on the power supply until you are ready to start the pump.

10.5.1 Versions with mains plug

- Insert the mains plug in the mains socket.

10.5.2 Versions without mains plug



Warning

The pump must be connected to an external clearly labelled mains switch with a minimum contact gap of 3 mm in all poles.

- Connect the motor to the power supply in accordance with local electrical installation regulations and the connection chart on the terminal box cover.



Warning

The specified enclosure class can only be ensured if the power supply cable is connected with the same degree of protection.

Observe the direction of rotation!

To protect the motor, install a motor protecting switch or motor contactor, and set the bimetal relay to the rated motor current for the available voltage and frequency.

Caution

11. Start-up/shutdown

11.1 Initial start-up/subsequent start-up

Warning

When dosing dangerous media, observe the corresponding safety precautions!

Wear protective clothing (gloves and goggles) when working on the dosing head, connections or lines!



Before removing the dosing head, valves and lines, empty any remaining medium in the dosing head into a drip tray by carefully unscrewing the suction valve.

The pump housing must only be opened by personnel authorised by Grundfos!

Repairs must only be carried out by authorised and qualified personnel!

Observe the flow direction of valves (indicated by an arrow on the valve)!

Caution

Only tighten plastic valves by hand.

11.1.1 Checks before start-up

- Check that the rated voltage stated on the pump nameplate corresponds to the local conditions!
- Check that all connections are secure and tighten, if necessary.
- Check that the dosing head screws are tightened with the specified torque and tighten, if necessary.
- Check that all electrical connections are correct.
- Cross-tighten the dosing head screws using a torque wrench.

Torques

Pump type	Torque [Nm]
DMH 251, 10 bar	8-10
DMH 251, 16 bar	10-12
DMH 251, 25 bar	13-15
DMH 252	8-10
DMH 253	10-12
DMH 254	50-54
DMH 255	50-54
DMH 257	50-54

11.1.2 Oil filling

The pump is factory-checked, and the oil is drained for shipping purposes. Before start-up, add the special oil supplied with the pump.

Note

The piston flange is filled with oil for easy start-up. The stroke-length adjustment knob must only be adjusted if the gear oil has been added, otherwise the oil will leak from the piston flange.

- Slacken and remove the oil-filling screw (F).
- Slowly add the hydraulic oil supplied with the pump through the oil-filling opening (F) until the oil reaches the mark on the oil dipstick.
- Set the stroke-length adjustment knob (L) to "0".

11.1.3 Filling the dosing head for the initial start-up for systems without flooded suction



Warning

When dosing dangerous media, observe the corresponding safety precautions!
Wear protective clothing (gloves and goggles) when working on the dosing head, connections or lines!

As assisting suction for systems without flooded suction, you can fill the dosing head with dosing medium before the initial start-up:

1. Unscrew the discharge valve (3b).
2. Add the dosing medium to the dosing head (2).
3. Screw the discharge valve (3b) back in.

Note Observe the flow direction of the discharge valve (indicated by an arrow on the valve)!

11.2 Start-up/subsequent start-up of DMH 251, 252 and 253

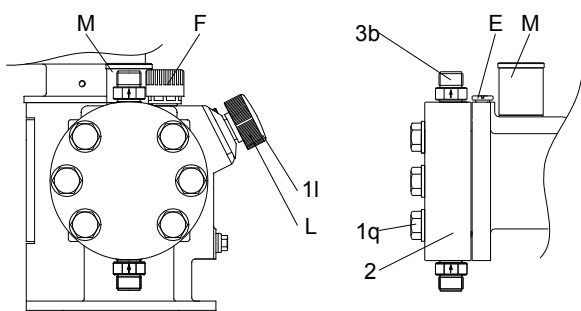

Fig. 26 Start-up of DMH 251, 252 and 253

Pos.	Components
1q	Dosing head screws
2	Dosing head
3b	Discharge valve
E	Degassing valve
F	Oil-filling screw with dipstick
L	Stroke-length adjustment knob
1l	Cover for stroke-length adjustment knob
M	Pressure relief valve

1. Connect the electrical power supply.
2. Depending on the installation, start the pump, where possible, without counter-pressure.

See installation example for easy deaeration of the dosing head in section 9. *Installation*.

3. Set the stroke-length adjustment knob (L) to 0 %.
4. Let the pump run for approx. 5 minutes.
5. Check the oil level.
 - Set the stroke-length adjustment knob (L) to 40 %.
 - Let the pump run for approx. 10 minutes with a stroke-length setting of 40 %.
 - Switch off the pump, check the oil level and add oil, if necessary.
 - Refit the oil-filling screw (F).
6. Deaerate the piston flange.
 - Set the stroke-length adjustment knob (L) to 15 %.
 - Loosen the degassing valve (E) by one turn to the left.
 - Let the pump run for approx. 5 minutes.
 - Re-tighten the degassing valve (E).

The pump is now ready for operation.

Warning

Risk of injury caused by squirting oil!
Oil may squirt from the oil deaeration when the pump is running. Do not completely unscrew the oil deaeration screw.
Wear protective clothing (gloves and goggles) when working on the dosing head, connections or lines!



Note Rod length of oil dipstick: 27 mm.
Immersion depth to marking: approx. 5 mm.

Check the oil level at least every two weeks and add oil, if necessary.
Note Only use original Grundfos gear oil!
For product number, see service instructions.

Pump type	Version	Description
DMH 251	Single/double	1.3 l white oil (Paraffin 55 DAB7)
DMH 252, 10 bar	Single/double	1.3 l white oil (Paraffin 55 DAB7)
DMH 252, 16 bar	Single/double	1.3 l DHG 68
DMH 253	Single/double	1.3 l DHG 68

After start-up

After initial start-up and after each time the diaphragm is changed, tighten the dosing head screws.
Caution After approximately 6-10 operating hours or two days, cross-tighten the dosing head screws using a torque wrench.

Torques

Pump type	Torque [Nm]
DMH 251, 10 bar	8-10
DMH 251, 16 bar	10-12
DMH 251, 25 bar	13-15
DMH 252	8-10
DMH 253	10-12

11.3 Start-up/subsequent start-up of DMH 254, 255 and 257

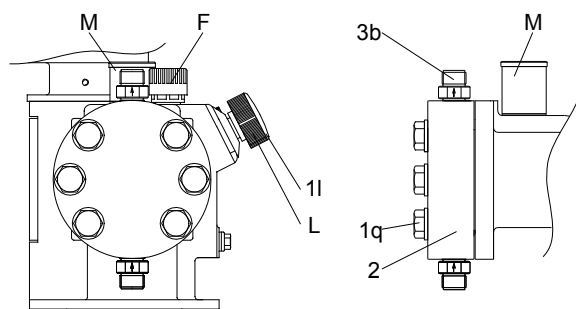

Fig. 27 Start-up of DMH 254, 255 and 257

Pos.	Components
1q	Dosing head screws
2	Dosing head
3b	Discharge valve
F	Oil-filling screw with dipstick
L	Stroke-length adjustment knob
1l	Cover for stroke-length adjustment knob
M	Pressure relief valve

1. Connect the electrical power supply.
 2. Depending on the installation, start the pump, where possible, without counter-pressure.
- See installation example for easy deaeration of the dosing head in section 9. *Installation*.
3. Set the stroke-length adjustment knob (L) to 0 %.
 4. Let the pump run for approx. 5 minutes.
 5. Check the oil level.
 - Set the stroke-length adjustment knob (L) to 40 %.
 - Let the pump run for approx. 10 minutes with a stroke-length setting of 40 %.
 - Switch off the pump, check the oil level and add oil, if necessary.
 - Refit the oil-filling screw (F).

The pump is now ready for operation.

Warning

Risk of injury caused by squirting oil!

Oil may squirt from the oil deaeration when the pump is running. Do not completely unscrew the oil deaeration screw.

Wear protective clothing (gloves and goggles) when working on the dosing head, connections or lines!



Rod length of oil dipstick: 35 mm.

Note

Immersion depth to marking: approx. 5 mm.

Check the oil level at least every two weeks and add oil, if necessary.

Note

Only use original Grundfos gear oil!

For product number, see service instructions.

Pump type	Version	Description
DMH 254	Single	3.5 l DHG 68
DMH 254	Double	4.5 l DHG 68
DMH 255	Single	3.5 l DHG 68
DMH 255	Double	4.5 l DHG 68
DMH 257	Single	5.5 l DHG 68
DMH 257	Double	7.5 l DHG 68

After start-up

After initial start-up and after each time the diaphragm is changed, tighten the dosing head screws.

Caution

After approximately 6-10 operating hours or two days, cross-tighten the dosing head screws using a torque wrench.

Torques

Pump type	Torque [Nm]
DMH 254	50-54
DMH 255	50-54
DMH 257	50-54

11.4 Setting the pressure relief valve

The pressure relief valve is set to the pressure given by the customer, or to the rated pressure (maximum counter-pressure). The opening pressure can be set to a lower value by the customer.

Opening pressure of the pressure relief valve

Rated pressure of the pump [bar]	Opening pressure of the pressure relief valve [bar]
4	5
10	13
16	18
25	28

Setting the opening pressure

- To set the operating pressure, a pressure gauge must be installed in the discharge line and an isolating valve must be installed after the pressure gauge.
- To set the pressure relief valve, use a screwdriver.

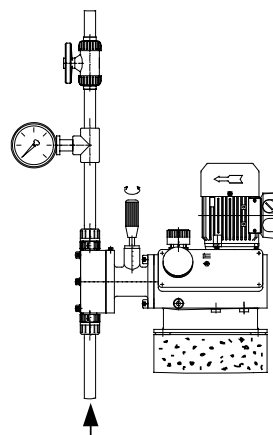

Fig. 28 Setting the opening pressure

Set the pressure relief valve as follows:

1. Close the isolating valve after the pressure gauge.
2. Remove the cover (1m) from the pressure relief valve.
3. Start the pump.
4. Using a screwdriver, slowly turn the adjusting screw (2m) of the pressure relief valve counter-clockwise until the desired opening pressure is obtained.

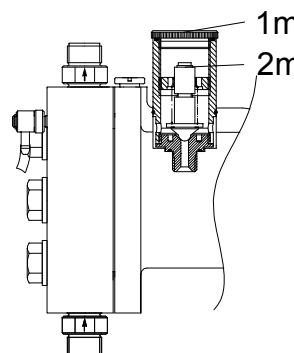

Fig. 29 Setting the pressure relief valve

Risk of damage to the pump or system!

When blocked, the pressure relief valve does not work properly and can produce pressures of several hundred bar in the pump or system. Do not block the pressure relief valve during adjustments!

Caution

5. Replace the cover of the pressure relief valve.
6. Open the isolating valve after the pressure gauge.

TM03 6464 1612

TM03 6465 4506

11.5 Zero point adjustments

11.5.1 Adjusting the zero point for system pressures up to 100 bar

The zero point of the dosing pump is factory-set to a slightly lower counter-pressure than the rated pressure of the pump. If the operating counter-pressure deviates considerably from this value, an adjustment of the zero point will ensure more precise values.

Counter-pressure at the factory-set zero point of the pump

Rated pressure of the pump [bar]	Counter-pressure at the factory-set zero point [bar]
10	3
16	3
25	10

11.5.2 Adjusting the zero point

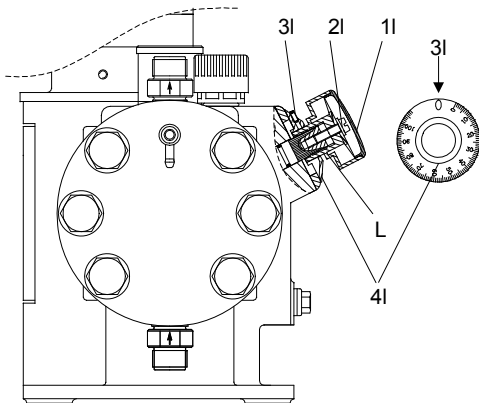

TM03 6466 4506

Fig. 30 Adjusting the zero point

Pos.	Components
L	Stroke-length adjustment knob
1l	Cover
2l	Locking screw
3l	Screw
4l	Scale ring

Warning

When dosing dangerous media, observe the corresponding safety precautions!

Wear protective clothing (gloves and goggles) when working on the dosing head, connections or lines!

Always adjust the value with the discharge line connected and with operating counter-pressure.

1. Fit a measuring device on the suction side, for instance place the suction line in a graduated measuring beaker.
2. Set the dosing flow to 15 %.
3. Remove the cover (1l) from the stroke-length adjustment knob (L).
4. Use a screwdriver to loosen the locking screw (2l) by approximately 2 turns.
5. Switch on the pump.
6. Slowly turn the stroke-length adjustment knob towards the zero point until the dosing (the liquid level falls) stops in the measuring device.
7. Switch off the pump.

8. Set the scale ring (4l) to zero.
 - Loosen the screw (3l) in the scale ring (4l) slightly using an hexagon key, M3.
 - Turn the scale ring (4l) until both "0" are the same on the scale and scale ring.
 - Tighten the screw (3l).
9. Depending on the application, tighten the locking screw (2l) so that the stroke-length adjustment knob can still be turned/cannot be turned any more.
10. Replace the cover (1l).

11.6 Operating the pump

Note

When operating the pump, see sections 12. Operation and 13. Maintenance and, if necessary, section 14. Fault finding chart.

11.7 Shutdown

Warning



Wear protective clothing (gloves and goggles) when working on the dosing head, connections or lines!
Do not allow any chemicals to leak from the pump. Collect and dispose of all chemicals correctly!

Note

If possible, rinse the dosing head before shutting down the pump, e.g. by supplying it with water.

11.7.1 Switching off / uninstalling

1. Switch off the pump and disconnect it from the power supply.
2. Depressurise the system.
3. Take suitable steps to ensure that the returning dosing medium is safely collected.
4. Carefully remove all lines.
5. Uninstall the pump.

11.7.2 Cleaning

1. Rinse all parts that have come into contact with the medium very carefully:
 - lines
 - valves
 - dosing head
 - diaphragm.
2. Remove any trace of chemicals from the pump housing.

11.7.3 Storage

Storage of the pump:

1. After cleaning (see section 11.7.2 *Cleaning*), carefully dry all parts and reinstall the dosing head and valves, or
2. change the valves and diaphragm.

See section 13. *Maintenance*.

11.7.4 Disposal

Disposal of the pump:

- After cleaning (see section 11.7.2 *Cleaning*), dispose of the pump in accordance with the relevant regulations.

12. Operation

12.1 Switching on/off

Caution

Before switching on the pump, check that it is installed correctly. See sections 9. Installation and 11. Start-up/shutdown.

- To start the pump, switch on the power supply.
- To stop the pump, switch off the power supply.

12.2 Setting the dosing capacity

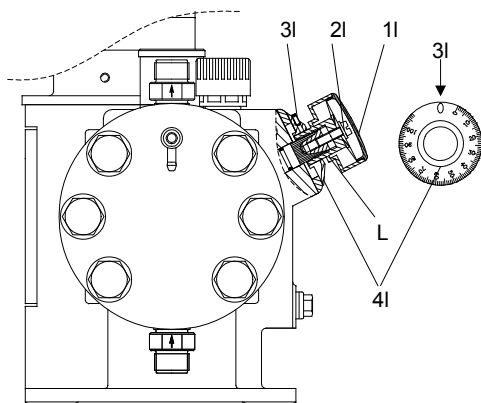

TM03 6466 4506

Fig. 31 Setting the dosing capacity

Pos.	Components
L	Stroke-length adjustment knob
1l	Cover
2l	Locking screw
3l	Screw
4l	Scale ring

12.2.1 Setting the dosing flow and locking the stroke-length adjustment knob

1. Remove the cover (1l) from the stroke-length adjustment knob (L).
2. Use a screwdriver to loosen the locking screw (2l) by approximately 2 turns.
3. Increase or *reduce* the dosing flow while the pump is running.
 - Slowly turn the stroke-length adjustment knob to the left or *right* to set the desired dosing volume.
4. Depending on the application, tighten the locking screw (2l) so that the stroke-length adjustment knob can still be turned/cannot be turned any more.
5. Replace the cover (1l).

The pump cannot be operated if the stroke-length adjustment knob is fully open! Depending on the pump adjustment, this value may already be lower than 100 % on the scale for system pressures higher than 100 bar.

Caution

Open the stroke-length adjustment knob completely and then close by approx. 10 % in order to set the dosing flow to 100 %.

12.3 Using the AR control unit (optional)

When using the AR control unit, observe the installation and operating instructions for the "AR control unit" in addition to the instructions in this manual.

12.4 Electric servomotor (optional)

To operate the servomotor, see the installation and operating instructions for the servomotor.

12.5 Electronic preselection counter (optional)

To operate the preselection counter, see the installation and operating instructions for the counter.

12.6 Electrically heated dosing head (optional)

To operate the temperature controller, see the installation and operating instructions for the temperature controller.

13. Maintenance

13.1 General notes

Warning

When dosing dangerous media, observe the corresponding safety precautions!

Wear protective clothing (gloves and goggles) when working on the dosing head, connections or lines!

The pump housing must only be opened by personnel authorised by Grundfos!

Repairs must only be carried out by authorised and qualified personnel!

Switch off the pump and disconnect it from the power supply before carrying out maintenance work and repairs!

Before removing the dosing head, valves and lines, empty any remaining medium in the dosing head into a drip tray by carefully unscrewing the suction valve.



Observe the flow direction of valves (indicated by an arrow on the valve)!

Only tighten plastic valves by hand.

Caution

13.2 Diaphragm leakage control for diaphragm leakage detection

If a diaphragm leakage (MLS) has been detected, first of all check whether an error has been displayed, as different external factors such as the heating of dosing or hydraulic medium can cause the cracked medium between the diaphragms to be displaced into the valve, thereby causing an error to occur.

Checks after a diaphragm leakage detection:

1. Briefly open the deaeration screw (2u) and then close it again.
2. Switch on the pump.
3. If, after a short period of time, a diaphragm leakage is detected again, a diaphragm has broken.

After a diaphragm breakage, replace the diaphragms and clean the non-return valve, see section 13.7 Replacing the diaphragm for dosing head with double diaphragm.

Caution

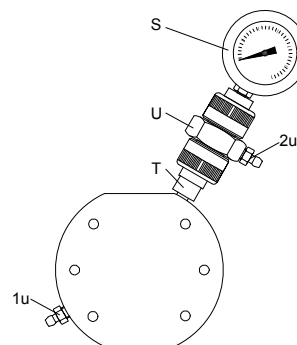

TM03 6467 4506

Fig. 32 Dosing head with double diaphragm

Pos.	Components
S	Contact pressure gauge
T	Ball non-return valve
U	Connection piece
1u	Filling screw
2u	Deaeration screw

13.3 Cleaning and maintenance intervals

Checking the oil level

- Check the oil level every two weeks and add oil, if necessary.

Cleaning the valves

- At least every 12 months or after 4,000 operating hours.
- If the pump does not perform.
- In the event of a fault.

Clean the valves and replace, if necessary (for stainless-steel valves: inner valve parts).

Changing diaphragms and gear oil

- At least every 12 months or after 8,000 operating hours, change the dosing medium and gear oil.
- In dusty installation sites, change the gear oil every 3,000 operating hours.

Cleaning the ball non-return valve of the double diaphragm

- After a diaphragm breakage, remove the ball non-return valve immediately and clean it.

Note

Only clean the ball non-return valve after a diaphragm breakage!

13.4 Checking the oil level

Caution

Check the oil level at least every two weeks and add oil, if necessary.

Rod length of oil dipstick:

DMH 251-253: 27 mm.

Note

DMH 254-257: 35 mm.

Immersion depth to marking: approx. 5 mm.

13.5 Cleaning the suction and discharge valves

Warning

Wear protective clothing (gloves and goggles) when working on the dosing head, connections or lines!

Before removing the dosing head, valves and lines, empty any remaining medium in the dosing head into a drip tray by carefully unscrewing the suction valve.



DN 8 valve

- Screwed connection 5/8"
- Stainless steel or plastic
- Spring-loaded (optional).

DN 20 valve (valve for suction side only), with adapter

- Screwed connection 1 1/4"
- Plastic.

DN 20 valve

- Screwed connection 1 1/4"
- Stainless steel or plastic
- Spring-loaded (optional).

DN 32 valve (for 60 Hz operation, suction side only), with adapter

- Flange connection
- Stainless steel or plastic.

Clean the suction and discharge valves as follows:

1. Unscrew the valves.
2. Unscrew the screw parts and valve set using round pliers.
3. Dismantle the inner part (seat, O-ring, balls, ball cages and, if present, spring).
4. Clean all parts. Replace faulty parts by new ones.
5. Re-assemble the valve.
6. Replace the O-rings by new ones. Refit the valve.

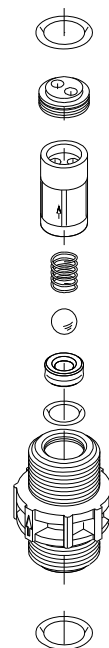

Fig. 33 Stainless-steel or plastic DN 8 valve, spring-loaded as an option

TM03 6468 4506

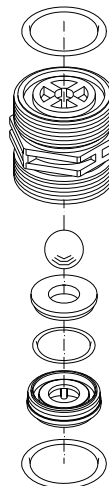

Fig. 34 Plastic DN 20 valve

TM03 6469 4506

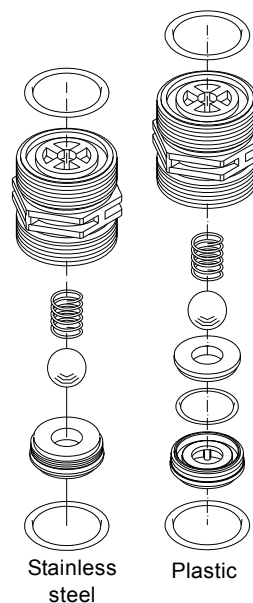

Fig. 35 Stainless-steel or plastic DN 20 valve, spring-loaded as an option

TM03 6470 4506

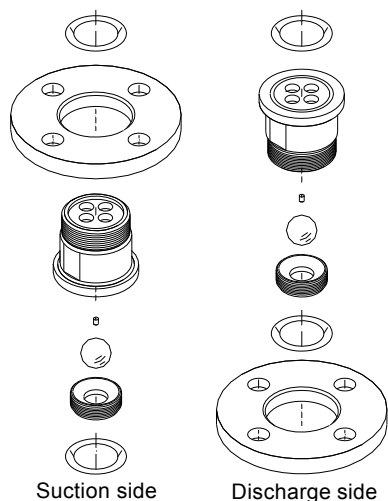

Fig. 36 DN 32 valve, suction side and discharge side

The O-rings must be correctly placed in the specified groove.

Caution Observe the flow direction (indicated by an arrow on the valve)!

Only tighten plastic valves by hand.

13.6 Replacing the diaphragm and gear oil for dosing head with single diaphragm (no diaphragm leakage detection)

Warning

Wear protective clothing (gloves and goggles) when working on the dosing head, connections or lines!



The dosing diaphragm should be replaced with each gear oil change.

Before removing the dosing head, valves and lines, empty any remaining medium in the dosing head into a drip tray by carefully unscrewing the suction valve.

Note Only use original Grundfos gear oil!
For product number, see service instructions.

Pump type	Version	Description
DMH 251	Single/double	1.3 l white oil (Paraffin 55 DAB7)
DMH 252, 10 bar	Single/double	1.3 l white oil (Paraffin 55 DAB7)
DMH 252, 16 bar	Single/double	1.3 l DHG 68
DMH 253	Single/double	1.3 l DHG 68
DMH 254	Single	3.5 l DHG 68
DMH 254	Double	4.5 l DHG 68
DMH 255	Single	3.5 l DHG 68
DMH 255	Double	4.5 l DHG 68
DMH 257	Single	5.5 l DHG 68
DMH 257	Double	7.5 l DHG 68

Note Collect the gear oil in a container and dispose of it correctly.

13.6.1 Drain gear oil

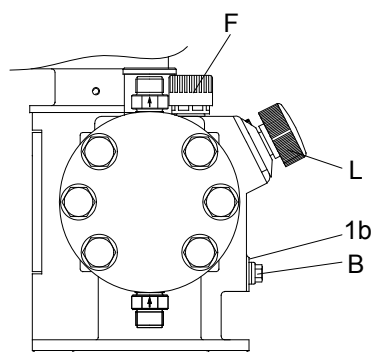

Fig. 37 Drain gear oil

Pos.	Components
B	Locking screw
1b	Gasket
F	Oil-filling screw with dipstick
L	Stroke-length adjustment knob

- Unscrew the locking screw (B) and collect the gear oil in a container.
- Screw the locking screw (B) and the new gasket (1b) back in and tighten securely.

Risk of leaking oil and damage caused by oil loss!

Caution For each oil change, a new flat gasket (1b) must be fitted!

13.6.2 Removing the dosing head

- Close the suction and discharge lines and loosen the suction and discharge valve connections.
- Loosen the six dosing head screws (1q with 2q).
- Remove the dosing head (2).

13.6.3 Replacing a single diaphragm (no diaphragm leakage detection)

- Remove the diaphragm and fit a new diaphragm (Q) on the suction side. See fig. 38.

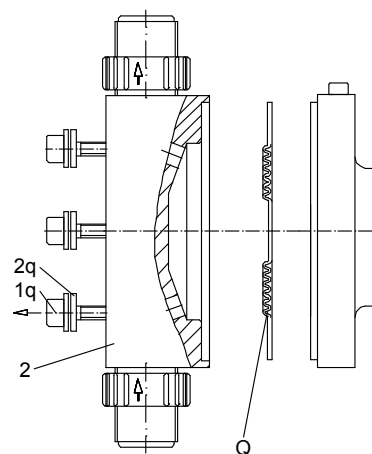

Fig. 38 Replacing a single diaphragm

Pos.	Components
1q	Dosing head screw
2q	Intermediate disk
2	Dosing head
Q	Diaphragm

TM03 6471 4506

TM03 6473 4506

13.6.4 Fitting the dosing head

- Fit the dosing head and cross-tighten the dosing head screws (1q with 2q) using a torque wrench.

Note See section 11. Start-up/shutdown for subsequent start-up!

13.6.5 Filling with gear oil

Risk of leaking oil and damage caused by oil loss!

Caution For each oil change, a new flat gasket (1b) must be fitted!

- Check that the locking screw (B) is tightened.
- Slacken and remove the oil-filling screw (F).
- Set the stroke-length adjustment knob (L) to "0".
- Slowly add the hydraulic oil through the oil-filling opening (F) until the oil reaches the mark on the oil dipstick.
- Wait 30 minutes.
- Let the pump run for approx. 5 minutes with a stroke-length setting of 0 %.
- Let the pump run for approx. 10 minutes with a stroke-length setting of 40 %.

13.6.6 Checking the oil level

- Switch off the pump, check the oil level and add oil, if necessary.
- Refit the oil-filling screw (F).

After initial start-up and after each time the diaphragm is changed, tighten the dosing head screws.

Caution After approximately 6-10 operating hours or two days, cross-tighten the dosing head screws using a torque wrench.

Torques

Pump type	Torque [Nm]
DMH 251, 10 bar	8-10
DMH 251, 16 bar	10-12
DMH 251, 25 bar	13-15
DMH 252	8-10
DMH 253	10-12
DMH 254	50-54
DMH 255	50-54
DMH 257	50-54

13.7 Replacing the diaphragm for dosing head with double diaphragm

Warning

Wear protective clothing (gloves and goggles) when working on the dosing head, connections or lines!



The dosing diaphragm should be replaced with each gear oil change.

Before removing the dosing head, valves and lines, empty any remaining medium in the dosing head into a drip tray by carefully unscrewing the suction valve.

Note Only use original Grundfos gear oil! For product number, see service instructions.

13.7.1 Removing the dosing head

- Close the suction and discharge lines and loosen the suction and discharge valve connections.
- Loosen the six dosing head screws (1q with 2q).
- Remove the dosing head (2).

13.7.2 Replacing a double diaphragm

- Clean the intermediate disk (3q), sealing rings (4q) and covering rings (5q). After a diaphragm breakage, replace the parts by new ones.
- Remove both clamping sleeves (6q) slightly using pliers. After a diaphragm breakage, replace the parts by new ones.
- Measure the outer wall thickness of both new diaphragms (Q1 and Q2): $s_{1(Q1)} < s_{2(Q2)}$.

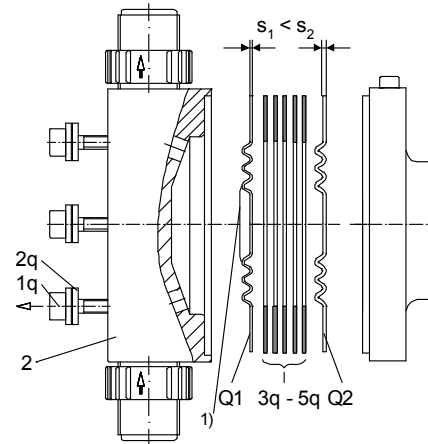

Fig. 39 Installation of diaphragm

- The shape of the diaphragm varies depending on pump type.

Pos.	Components
1q	Dosing head screw
2q	Intermediate disk
2	Dosing head
Q1/Q2	See fig. 40
3q - 5q	

Observe correct installation of diaphragms (Q1 and Q2)! See fig. 40.

Caution Fit the thinner diaphragm (Q1) on the dosing side and the thicker diaphragm (Q2) on the oil side/pump side!

- Fit both new diaphragms (Q1 and Q2) and the parts (3q - 5q) in the correct order, as is shown in the diagrams (the clamping sleeves (6q) are used for centring purposes).

TMO3 6474 4506

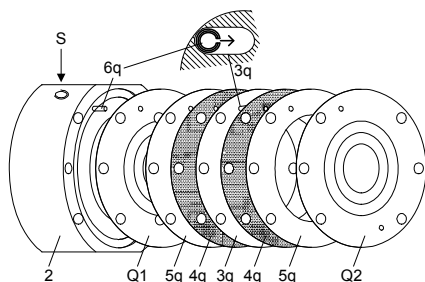

Fig. 40 Diaphragm on dosing-head side

TN03 6475 4506

Pos.	Components
S	Contact pressure gauge (installation position)
Q1	Diaphragm on dosing-head side
Q2	Diaphragm on oil side/pump side
3q	Intermediate disk
4q	Sealing rings
5q	Covering rings
6q	Clamping sleeves

The paraffin oil between the diaphragms (Q) is connected via the clamping sleeves (6q) to the contact pressure gauge (S) in order to fill and activate the diaphragm leakage detection. The oil is able to pass between the diaphragms through the slits in the clamping sleeves and the slits in the intermediate disk.

Caution

The clamping sleeves (6q) must therefore be installed in such a way that the slits in the clamping sleeve face the slits in the intermediate disk (3q). See fig. 40.

13.7.3 Fitting the dosing head

- Fit the dosing head and cross-tighten the dosing head screws using a torque wrench.

Note

See section 11. Start-up/shutdown for subsequent start-up!

13.7.4 Filling the double diaphragm with separating agent

After a diaphragm has broken, the ball non-return valve must be cleaned before the diaphragm is filled with separating agent. Only clean the ball non-return valve after a diaphragm breakage!

Caution

Pump with double diaphragm: After the diaphragm has been replaced, refill the separating agent between the diaphragms.

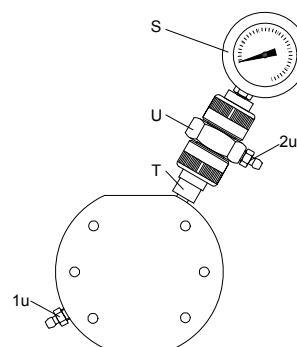

Fig. 41 Dosing head with double diaphragm

TN03 6467 4506

Pos.	Components
S	Contact pressure gauge
T	Ball non-return valve
U	Connection piece
1u	Filling screw
2u	Deaeration screw

- Set the stroke-length adjustment knob of the pump to 0 %.
- Open the filling screw (1u) and deaeration screw (2u) by one turn.
- Connect the filling hose to the nipple of the filling screw (1u) and, using the dosing syringe, inject the correct amount of paraffin oil that is specified in the table below.
- Close the filling screw (1u), but leave the deaeration screw (2u) open.
- Start the pump with a system counter-pressure and stroke-length setting of 40 %.
- Only close the deaeration screw (2u) when the separating agent stops flowing (after 5 to 10 minutes).

Note

After a few operating hours, especially if the pressure of the pressure gauge is increasing, deaerate the double diaphragm again.

Quantity of paraffin oil required for dosing pumps with a double diaphragm (per dosing head)

Pump type	Filling quantity [ml]
DMH 251-253	4
DMH 254	6
DMH 255	8
DMH 257	10

For ordering data for double-diaphragm filling components, see service instructions.

13.7.5 Filling with gear oil

Risk of leaking oil and damage caused by oil loss!

Caution

For each oil change, a new flat gasket (1b) must be fitted!

1. Check that the locking screw (B) is tightened.
2. Slacken and remove the oil-filling screw (F).
3. Set the stroke-length adjustment knob (L) to "0".
4. Slowly add the hydraulic oil through the oil-filling opening (F) until the oil reaches the mark on the oil dipstick.
5. Wait 30 minutes.
6. Let the pump run for approx. 5 minutes with a stroke-length setting of 0 %.
7. Let the pump run for approx. 10 minutes with a stroke-length setting of 40 %.

13.7.6 Checking the oil level

1. Switch off the pump, check the oil level and add oil, if necessary.
2. Refit the oil-filling screw (F).

After initial start-up and after each time the diaphragm is changed, tighten the dosing head screws.

Caution

After approximately 6-10 operating hours or two days, cross-tighten the dosing head screws using a torque wrench.

Torques

Pump type	Torque [Nm]
DMH 251, 10 bar	8-10
DMH 251, 16 bar	10-12
DMH 251, 25 bar	13-15
DMH 252	8-10
DMH 253	10-12
DMH 254	50-54
DMH 255	50-54
DMH 257	50-54

13.7.7 Cleaning the ball non-return valve

Note

Only clean the ball non-return valve after a diaphragm breakage!

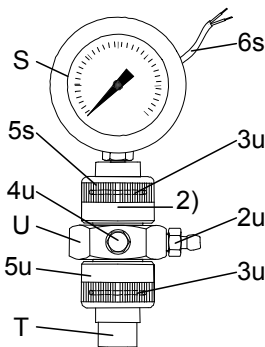

Fig. 42 Contact pressure gauge

TM03 6453 4506

Pos.	Components
S	Contact pressure gauge
5s	Union nut
6s	Contact output
T	Ball non-return valve
U	Connection piece
2u	Deaeration screw
3u	O-rings
4u	Connection for earth cable
5u	Union nut
* 2) or locking unit (instead of contact pressure gauge and its connection)	

Removing the ball non-return valve and contact pressure gauge

1. For pumps and pressure gauges in explosion-proof version, unscrew the earth cable (4u).
2. Hold the connection piece (U) with a screwdriver and unscrew the union nut (5u).
3. Unscrew the ball non-return valve (T) from the dosing head.

Cleaning the ball non-return valve

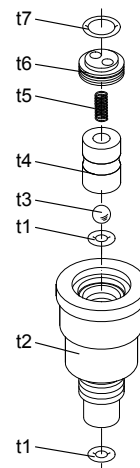

Fig. 43 Ball non-return valve

TM03 6476 4506

Pos.	Components
t1	O-ring
t2	Ball non-return valve body
t3	Ball
t4	Spring sheath
t5	Pressure spring
t6	Screw part
t7	O-ring

1. Unscrew the screw part (t6) using round pliers.
2. Clean all parts. Replace faulty parts by new ones.
3. Re-assemble the ball non-return valve.
4. Refit the ball non-return valve (T).
5. Screw the contact pressure gauge (S) and connection piece (U) back on.
6. For pumps and pressure gauges in explosion-proof version, screw the earth cable (4u) back on.

Caution **Tighten the ball non-return valve and connection piece by hand only.**

14. Fault finding chart



Warning

Actions that are taken to correct faults on the pump and that are not described in this manual, must only be carried out by personnel authorised by Grundfos!

Fault	Diagnosis	Cause	Remedy
No dosing flow even at a low counter-pressure. (Pump is running without any noise).	No motor sound or vibrations. Fan is not rotating.	Motor is not running.	Connect the power supply or replace the motor, if blown.
	When the oil-filling screw (F) is removed, use the dipstick to observe a calm oil surface. There is no "sloshing".	Motor runs, but the eccentric shaft is not rotating. No piston movement. Spiral pin or motor shaft broken.	Remove the motor and eccentric shaft. Replace damaged parts.
	Oil level too low. See oil dipstick (F). No reaction of the overpressure valve if the suction line is closed.	Not enough oil in the pump. Air is penetrating the piston flange through the control holes.	Fill in oil. Deaerate the pump, see section 11. Start-up/shutdown.
	No dosing flow on the discharge side.	Dosing head is not filled. Suction line empty. Tank empty.	Deaerate the dosing head. Fill/exchange the tank on the suction side.
No dosing flow even at a low counter-pressure. (Pump is running noisily although the overpressure valve reacted).	The overpressure valve reacts independently of the dosing flow adjustment (10 % to 100 %).	Valve on discharge side closed.	Open the valve.
		Counter-pressure is higher than the adjusted pressure at the overpressure valve.	Adjust the overpressure valve higher, but only if the pump is designed for this. Never block the overpressure valve.
		Discharge valve is installed in the opposite direction of the flow. Observe the arrow on the valve.	Install the discharge valve correctly.
	The diaphragm protection system (AMS) responds. The overpressure valve reacts independently of the dosing flow adjustment (10 % to 100 %).	Valve on suction side closed.	Open the valve.
		Suction filter obstructed.	Clean the suction filter. Replace, if necessary.
		Suction valve jammed (does not open).	Dismantle and check the suction valve.
		Suction valve has a too strong spring.	Use the fitting spring, or use double ball valve for checking.
		Suction valve is installed in the opposite direction of the flow. Observe the arrow on the valve.	Install the suction valve correctly.
The diaphragm protection system (AMS) responds. The overpressure valve reacts at 100 % dosing flow. When reducing the flow ~10 % to 20 %, the overpressure valve does not react any more.	Dosing head is not completely deaerated.	Fill the dosing head completely.	
	Pump is cavitating (dosing liquid with too high viscosity; dosing liquid with too high steam pressure at operating temperature = degassing of the liquid; suction lift too high; wrong design of the system on suction side).	Use a gear with a low stroke number; use valves with bigger nominal width; realise positive inlet pressure.	
Pump does not dose or pressure relief valve opens.	Diaphragm broken (not enough oil in the enclosure of the pump; piston flange).	Clean and grease well all parts using oil according to regulations. Then install a new diaphragm.	
		Discharge valve of pump is clogged or ball guide in the valve is worn due to corrosive or abrasive media.	Uninstall the discharge valve. Dismantle and clean, or if the bars of the ball guide are worn, replace the valve.

Fault	Diagnosis	Cause	Remedy
	Suction valve: During the discharge stroke, the dosing liquid flows back into the suction line. Discharge valve: During the suction stroke, the dosing liquid flows back into the dosing head. The pump takes in less.	Suction/discharge valves dirty or leaky.	Clean or replace valves.
Dosing flow too small.	Dosing flow depends very much on the pressure. If the counter-pressure is low, the dosing flow increases considerably. If the stroke frequency rises, the dosing flow increases excessively.	Too much clearance between piston and slide valve, or the stroke frequency of the pump is too low (too much slip).	Replace the piston and piston slide valves. Use other hydraulic oil with a higher viscosity (mainly for frequency converter operation and higher counter-pressures).
	Pressure gauge in discharge line.	Counter-pressure has seriously increased. Overpressure valve is adjusted too low.	Readjust the zero point. Correct the setting of the pressure relief valve.
	Especially at stroke frequencies below 15 strokes/min., e.g. frequency converter operation.	Degassing valve (M) is not working properly.	Replace the degassing valve (M) or, if necessary, replace with Ø8 ball.
Pump doses too much.	Pressure gauge in discharge line.	Counter-pressure has seriously dropped.	Readjust the zero point.
	Heavy overdose.	Inlet pressure of suction line higher than counter-pressure of discharge line.	Install a pressure-loading valve.
	Overdosing at high dosing flow settings and flows.	Too big dynamic in the suction line.	Install a pulsation damper on the suction side.

15. Dosing curves

The dosing curves on the following pages are trend curves.

They apply to:

- performance of single pump (the flow rate is doubled for the double pump)
- water as dosing medium
- zero point of pump Q_0 for specified pressure, see table below
- standard pump version.

Abbreviation	Description
Q	Dosing flow
Q_0	Zero point of the pump
h	Stroke length

DMH 251

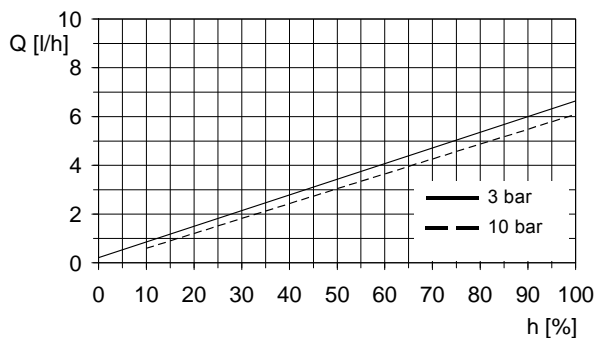

TM03 6477 4506

Fig. 44 DMH 5-10 (50 Hz), $Q_0 = 3$ bar

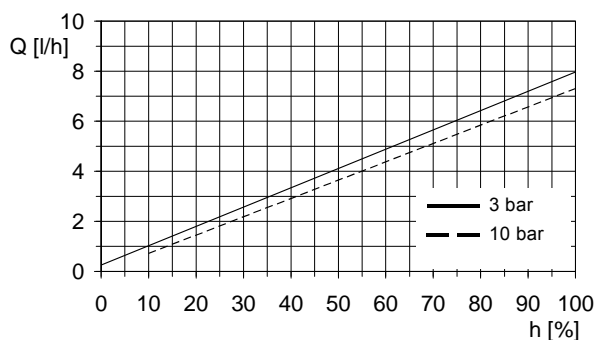

TM03 6478 4506

Fig. 45 DMH 5-10 (60 Hz), $Q_0 = 3$ bar

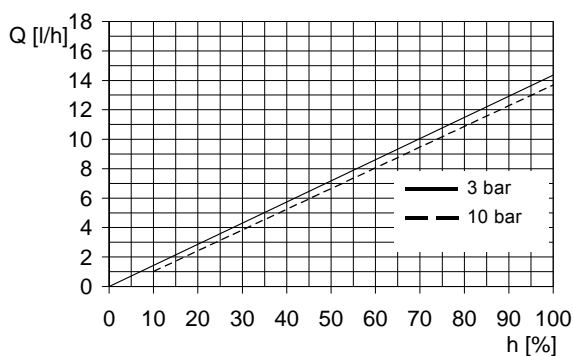

TM03 6479 4506

Fig. 46 DMH 13-10 (50 Hz), $Q_0 = 3$ bar

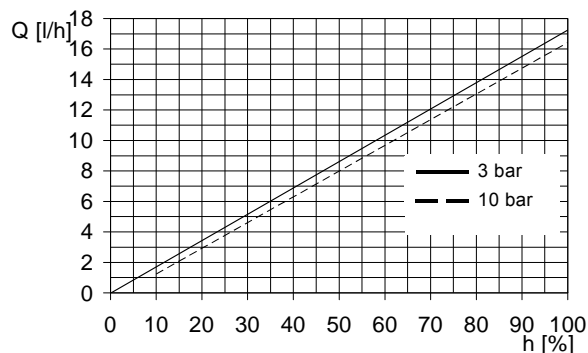

TM03 6480 4506

Fig. 47 DMH 13-10 (60 Hz), $Q_0 = 3$ bar

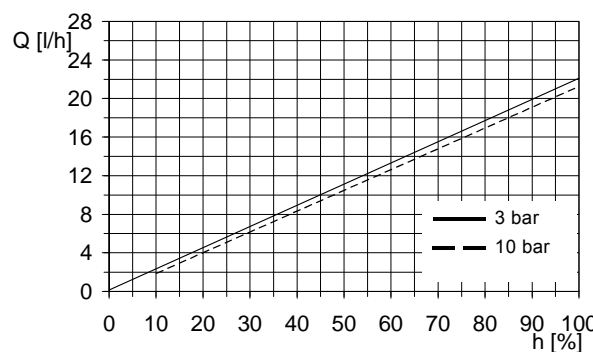

TM03 6481 4506

Fig. 48 DMH 19-10 (50 Hz), $Q_0 = 3$ bar

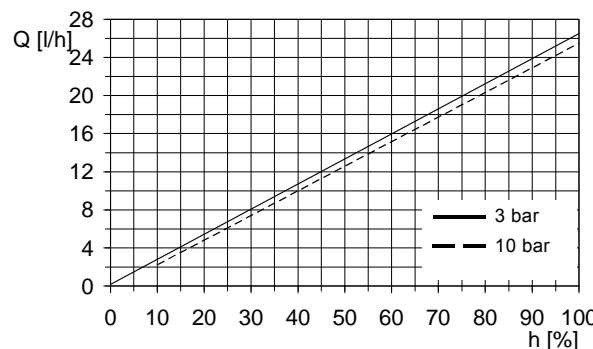

TM03 6482 4506

Fig. 49 DMH 19-10 (60 Hz), $Q_0 = 3$ bar

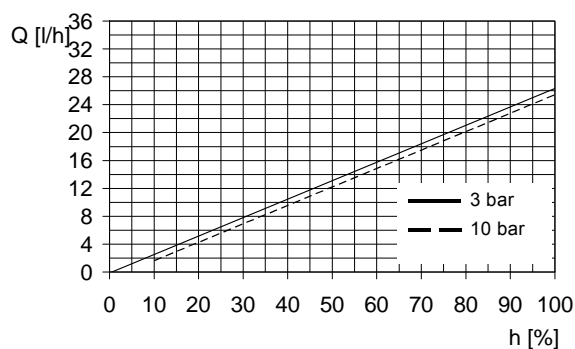

TM03 6483 4506

Fig. 50 DMH 24-10 (50 Hz), $Q_0 = 3$ bar

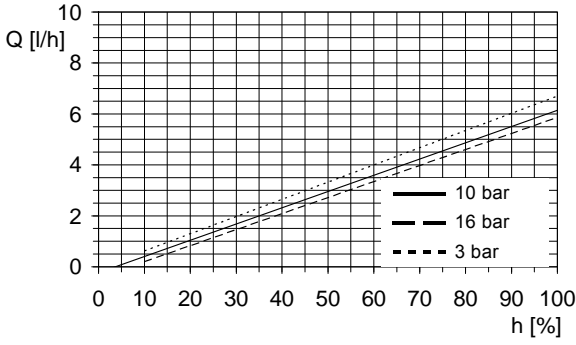

Fig. 51 DMH 4.9-16 (50 Hz), $Q_0 = 10$ bar

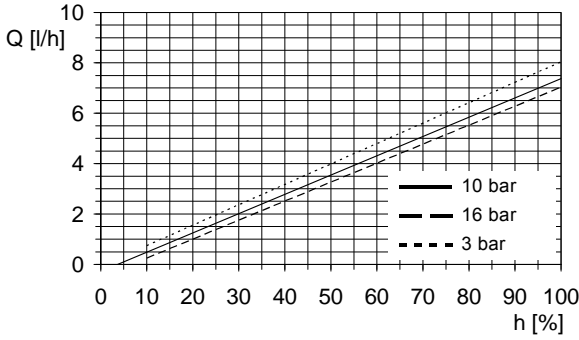

Fig. 52 DMH 4.9-16 (60 Hz), $Q_0 = 10$ bar

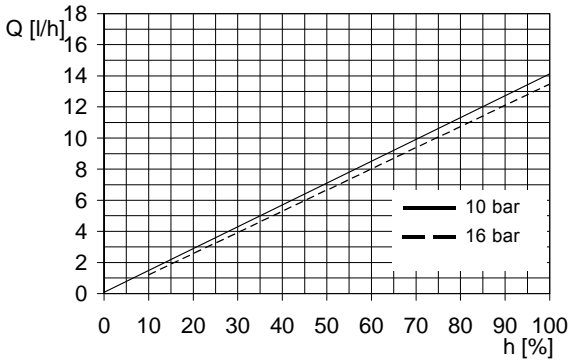

Fig. 53 DMH 12-16 (50 Hz), $Q_0 = 10$ bar

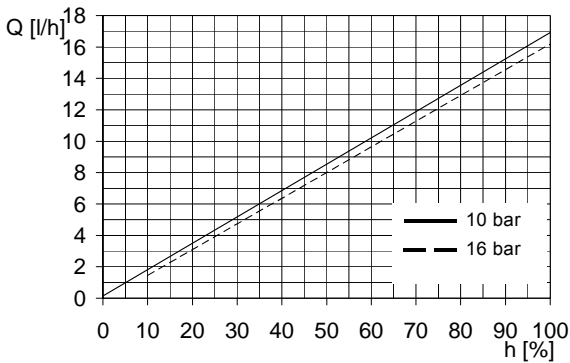

Fig. 54 DMH 12-16 (60 Hz), $Q_0 = 10$ bar

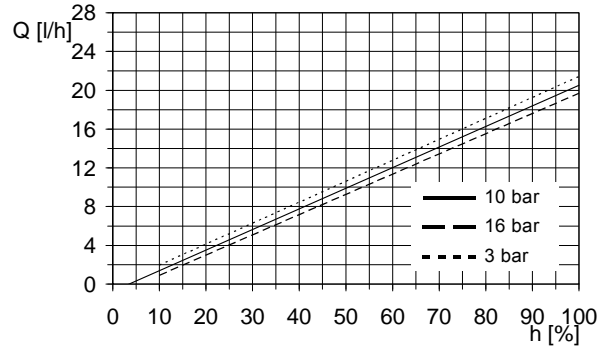

Fig. 55 DMH 18-16 (50 Hz), $Q_0 = 10$ bar

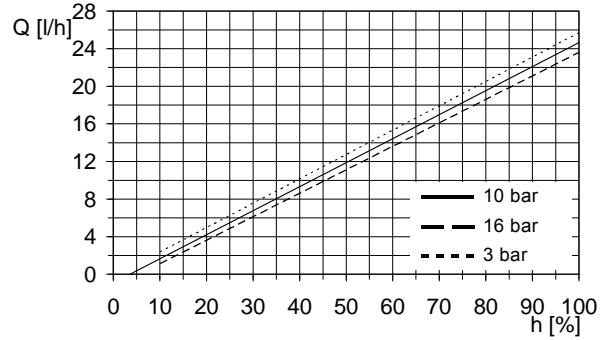

Fig. 56 DMH 18-16 (60 Hz), $Q_0 = 10$ bar

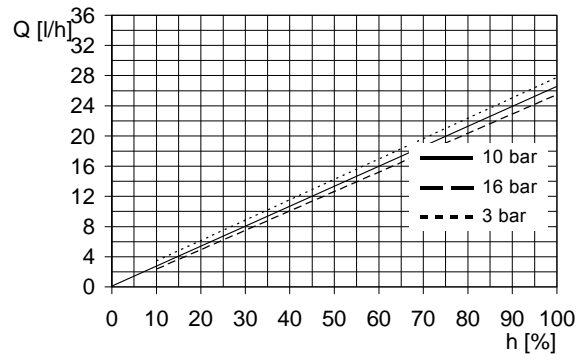

Fig. 57 DMH 23-16 (50 Hz), $Q_0 = 10$ bar

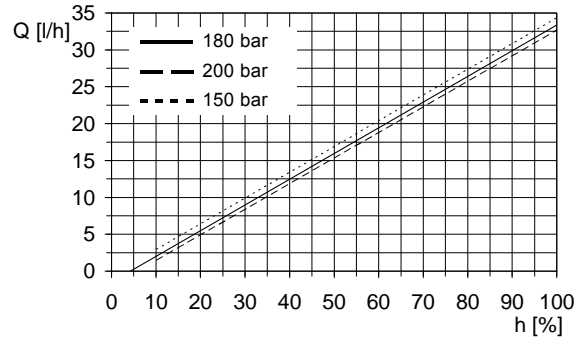

Fig. 58 DMH 23-16 (60 Hz), $Q_0 = 10$ bar

TM03 6484 4506

TM03 6485 4506

TM03 6486 4506

TM03 6487 4506

TM03 6488 4506

TM03 6489 4506

TM03 6490 4506

TM03 6491 4506

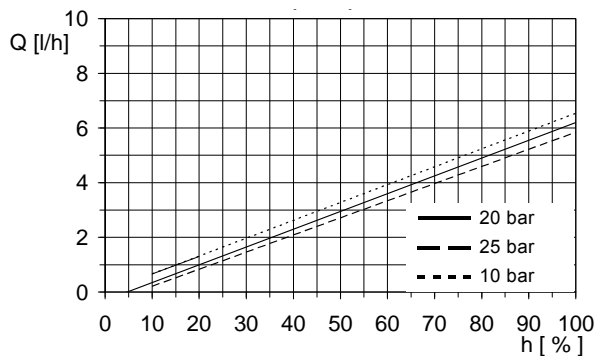

Fig. 59 DMH 4.5-25 (50 Hz), $Q_0 = 20$ bar

TM03 6492 4506

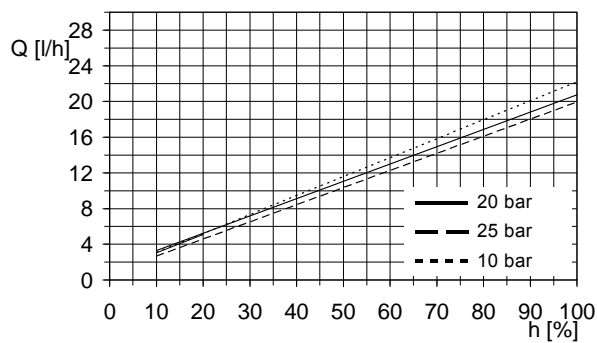

Fig. 63 DMH 17-25 (50 Hz), $Q_0 = 20$ bar

TM03 6496 4506

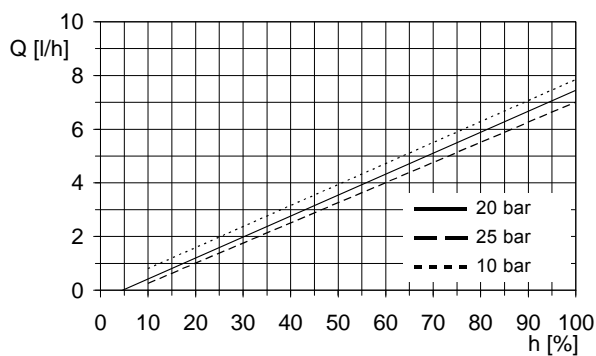

Fig. 60 DMH 4.5-25 (60 Hz), $Q_0 = 20$ bar

TM03 6493 4506

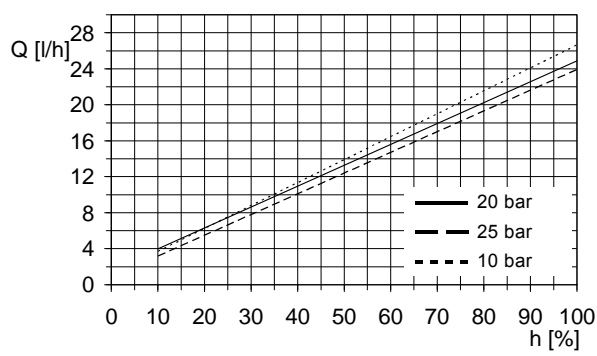

Fig. 64 DMH 17-25 (60 Hz), $Q_0 = 20$ bar

TM03 6497 4506

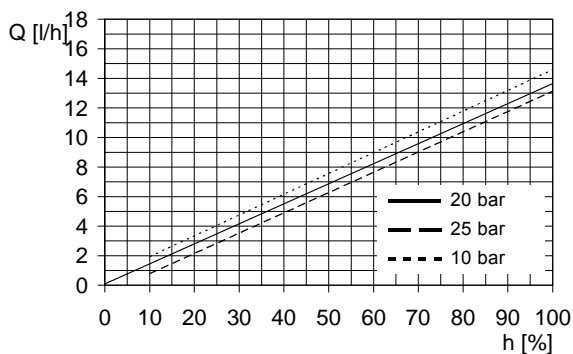

Fig. 61 DMH 11-25 (50 Hz), $Q_0 = 20$ bar

TM03 6494 4506

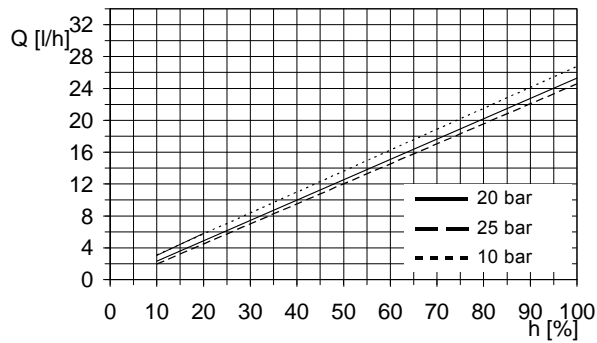

Fig. 65 DMH 21-25 (50 Hz), $Q_0 = 20$ bar

TM03 6498 4506

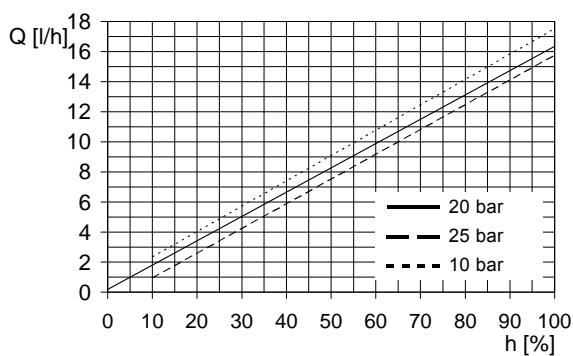

Fig. 62 DMH 11-25 (60 Hz), $Q_0 = 20$ bar

TM03 6495 4506

DMH 252

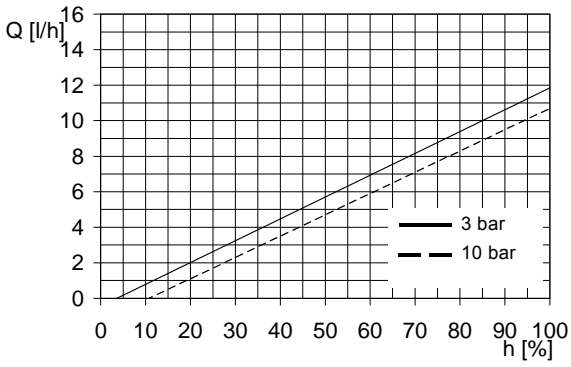

Fig. 66 DMH 11-10 (50 Hz), $Q_0 = 3$ bar

TM03 6499 4506

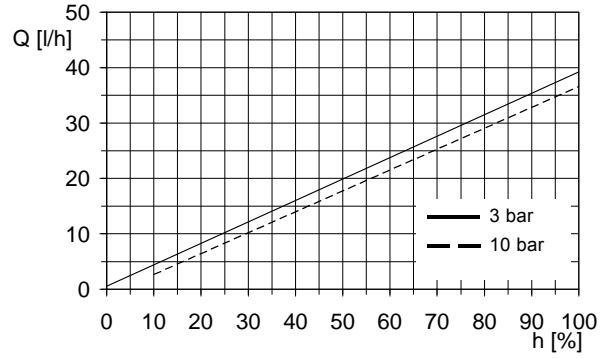

Fig. 70 DMH 37-10 (50 Hz), $Q_0 = 3$ bar

TM03 6503 4506

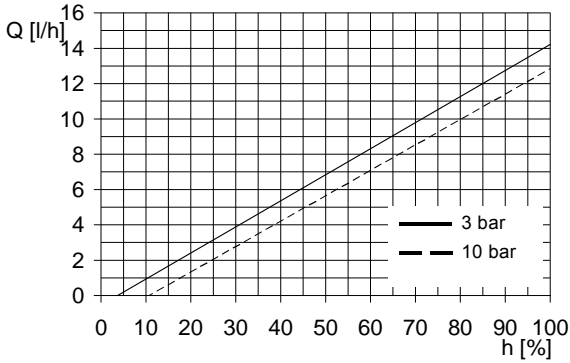

Fig. 67 DMH 11-10 (60 Hz), $Q_0 = 3$ bar

TM03 6500 4506

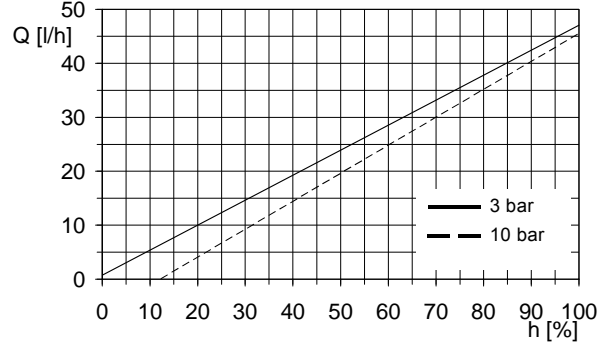

Fig. 71 DMH 37-10 (60 Hz), $Q_0 = 3$ bar

TM03 6504 4506

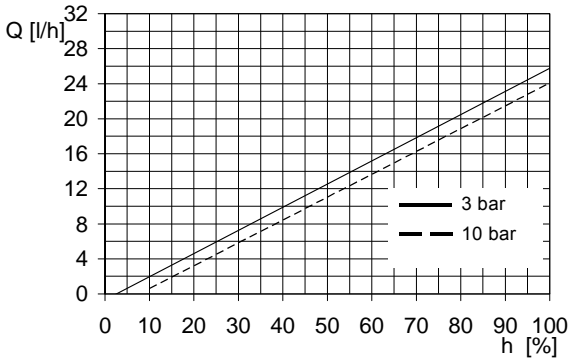

Fig. 68 DMH 24-10 (50 Hz), $Q_0 = 3$ bar

TM03 6501 4506

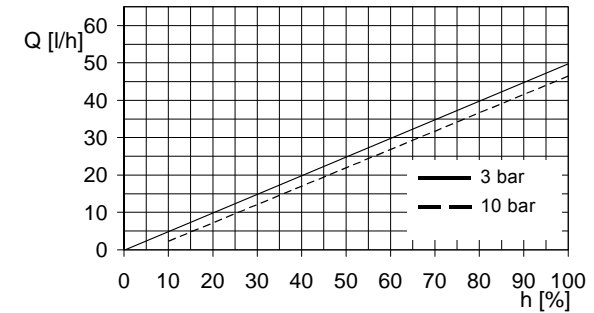

Fig. 72 DMH 46-10 (50 Hz), $Q_0 = 3$ bar

TM03 6505 4506

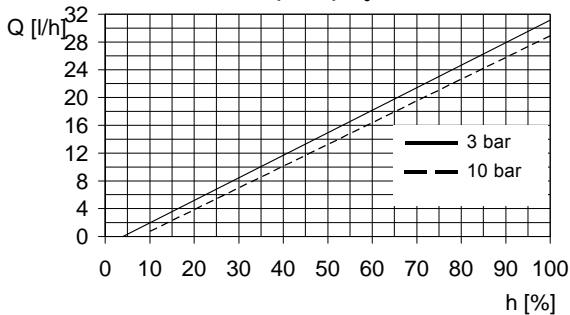

Fig. 69 DMH 24-10 (60 Hz), $Q_0 = 3$ bar

TM03 6502 4506

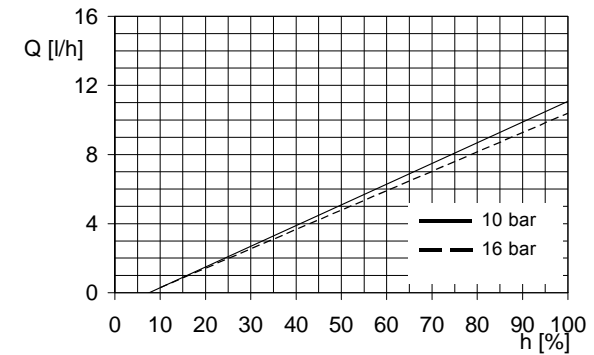
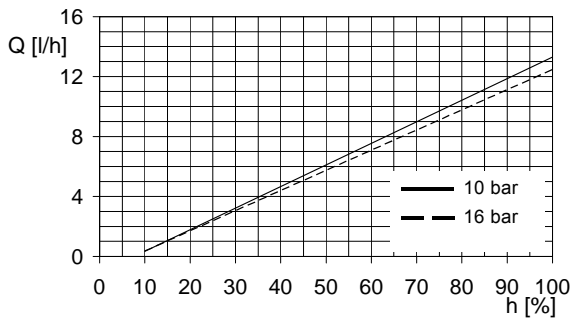

Fig. 73 DMH 10-16 (50 Hz), $Q_0 = 10$ bar

TM03 6506 4506



TM03 6507 4506

Fig. 74 DMH 10-16 (60 Hz), $Q_0 = 10$ bar

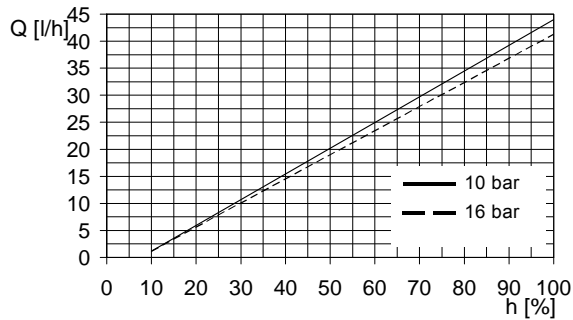

TM03 6511 4506

Fig. 78 DMH 36-16 (60 Hz), $Q_0 = 10$ bar

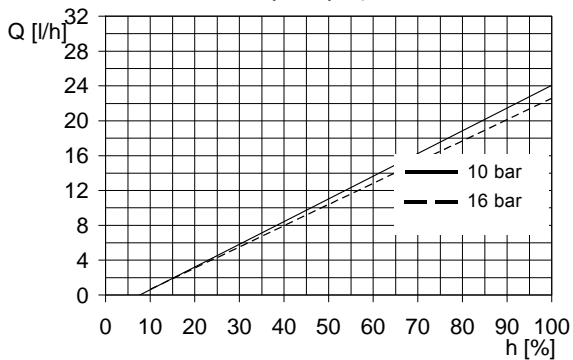

TM03 6508 4506

Fig. 75 DMH 23-16 (50 Hz), $Q_0 = 10$ bar

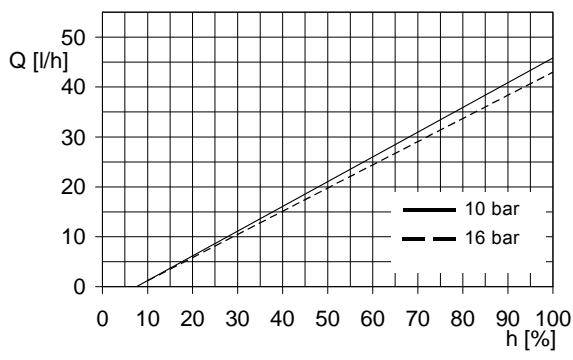

TM03 6512 4506

Fig. 79 DMH 45-16 (50 Hz), $Q_0 = 10$ bar

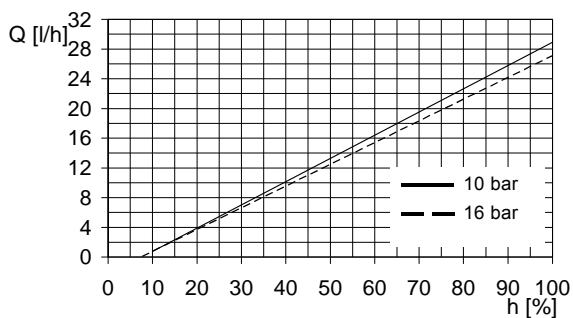

TM03 6509 4506

Fig. 76 DMH 23-16 (60 Hz), $Q_0 = 10$ bar

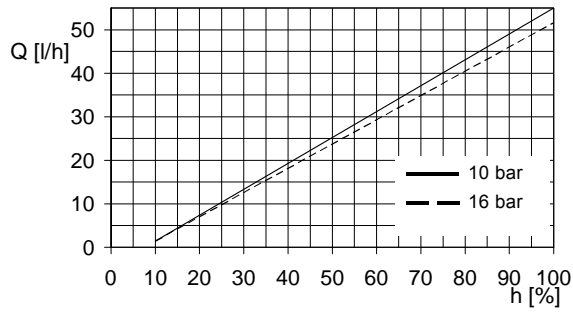

TM03 6513 4506

Fig. 80 DMH 45-16 (60 Hz), $Q_0 = 10$ bar

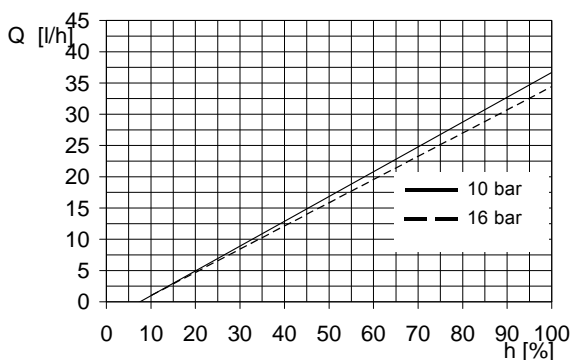

TM03 6510 4506

Fig. 77 DMH 36-16 (50 Hz), $Q_0 = 10$ bar

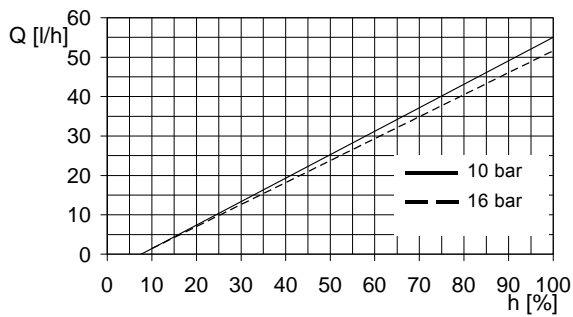

TM03 6514 4506

Fig. 81 DMH 54-16 (50 Hz), $Q_0 = 10$ bar

DMH 253

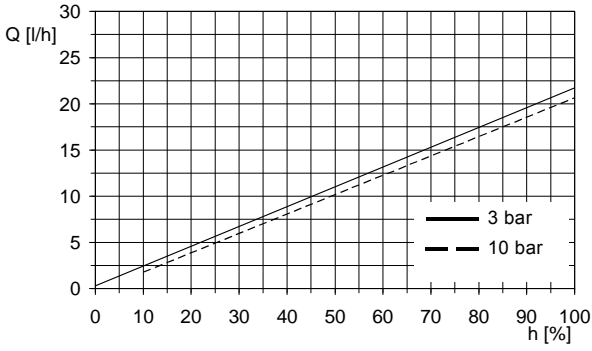

TM03 6515 4506

Fig. 82 DMH 21-10 (50 Hz), $Q_0 = 3$ bar

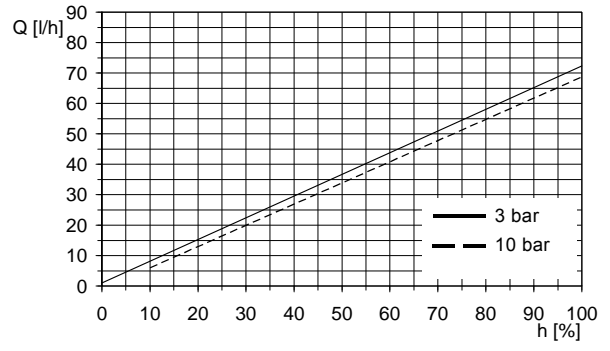

TM03 6519 4506

Fig. 86 DMH 67-10 (50 Hz), $Q_0 = 3$ bar

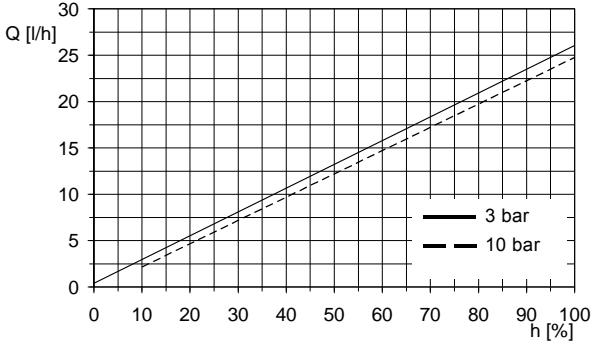

TM03 6516 4506

Fig. 83 DMH 21-10 (60 Hz), $Q_0 = 3$ bar

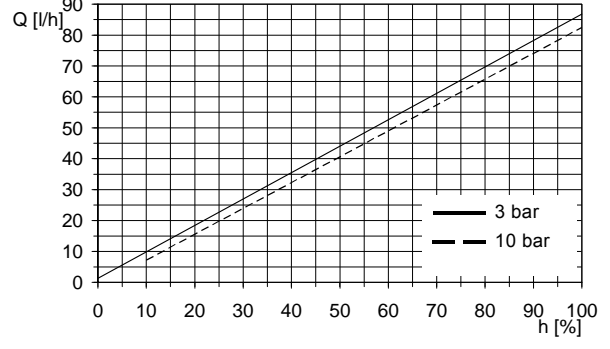

TM03 6520 4506

Fig. 87 DMH 67-10 (60 Hz), $Q_0 = 3$ bar

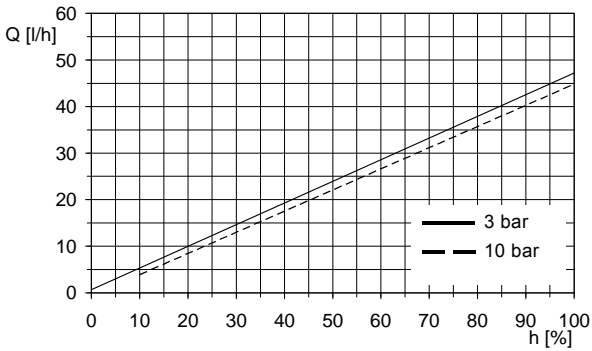

TM03 6517 4506

Fig. 84 DMH 43-10 (50 Hz), $Q_0 = 3$ bar

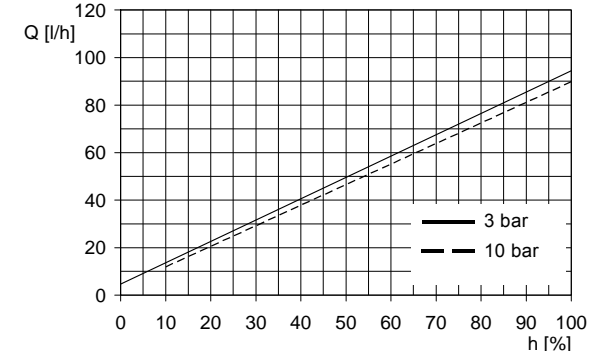

TM03 6521 4506

Fig. 88 DMH 83-10 (50 Hz), $Q_0 = 3$ bar

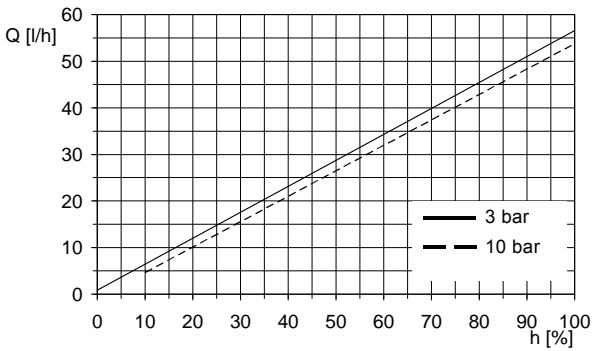

TM03 6518 4506

Fig. 85 DMH 43-10 (60 Hz), $Q_0 = 3$ bar

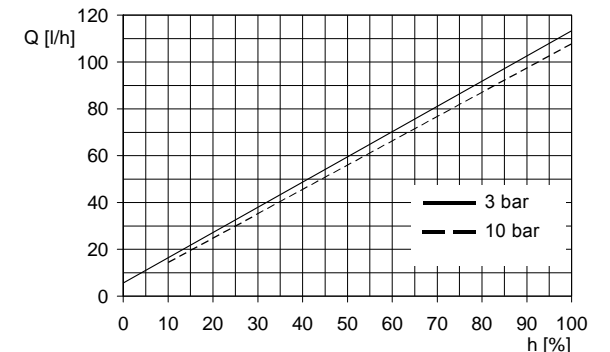

TM03 6522 4506

Fig. 89 DMH 83-10 (60 Hz), $Q_0 = 3$ bar

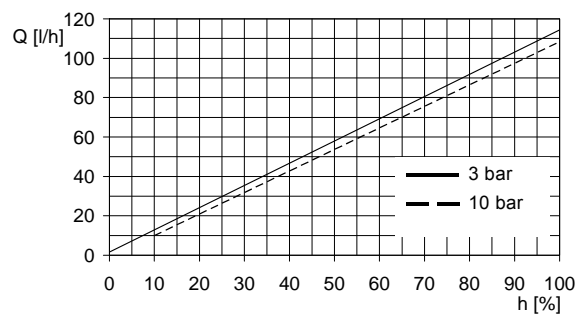

TM03 6523 4506

Fig. 90 DMH 100-10 (50 Hz), $Q_0 = 3$ bar

DMH 254

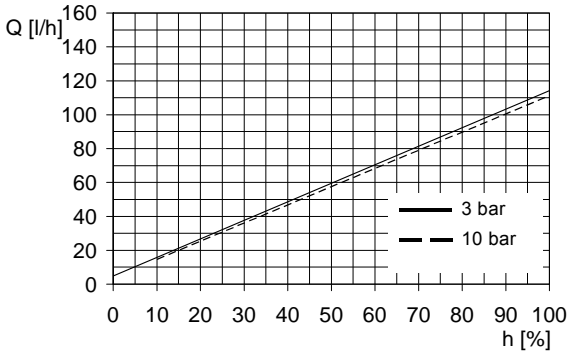

Fig. 91 DMH 102-10 (50 Hz), $Q_0 = 3$ bar

TM03 6524 4506

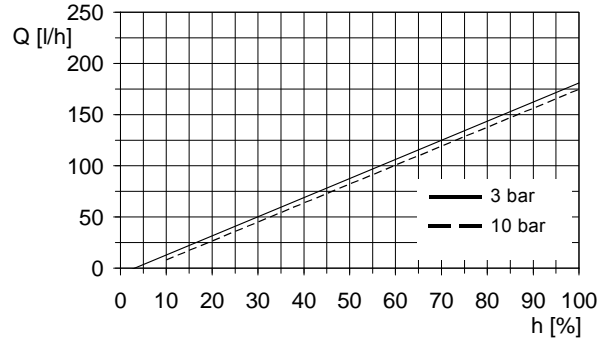

Fig. 95 DMH 175-10 (50 Hz), $Q_0 = 3$ bar

TM03 6528 4506

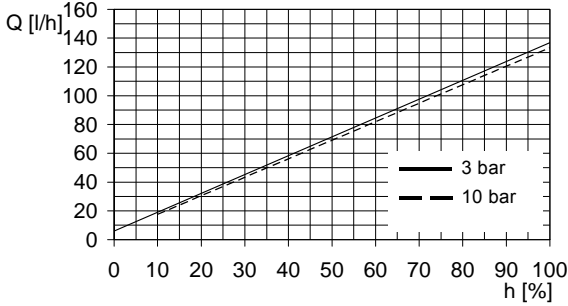

Fig. 92 DMH 102-10 (60 Hz), $Q_0 = 3$ bar

TM03 6525 4506

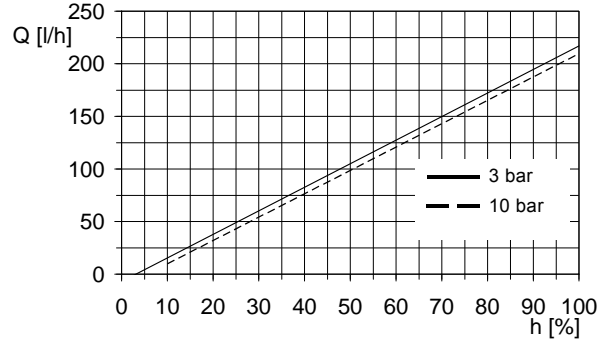

Fig. 96 DMH 175-10 (60 Hz), $Q_0 = 3$ bar

TM03 6529 4506

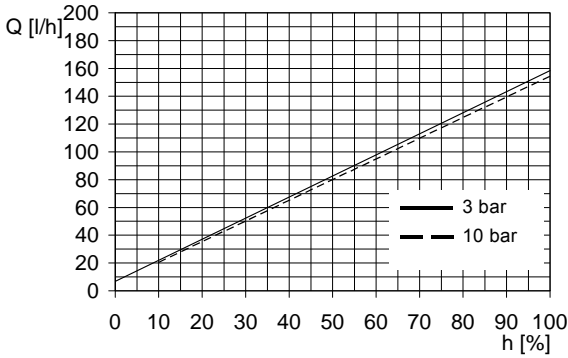

Fig. 93 DMH 143-10 (50 Hz), $Q_0 = 3$ bar

TM03 6526 4506

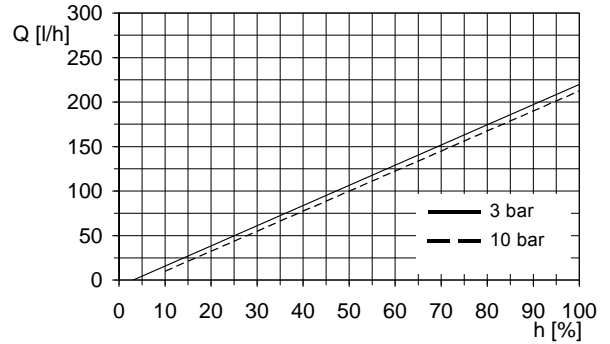

Fig. 97 DMH 213-10 (50 Hz), $Q_0 = 3$ bar

TM03 6530 4506

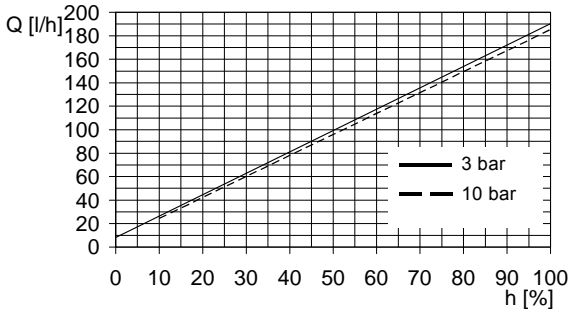

Fig. 94 DMH 143-10 (60 Hz), $Q_0 = 3$ bar

TM03 6527 4506

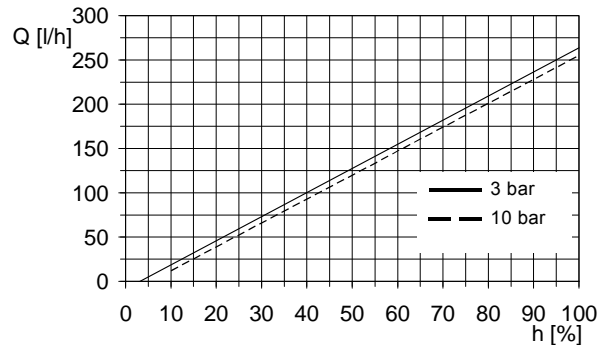

Fig. 98 DMH 213-10 (60 Hz), $Q_0 = 3$ bar

TM03 6531 4506

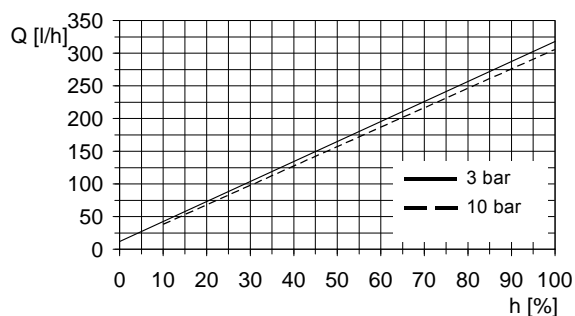

Fig. 99 DMH 291-10 (50 Hz), $Q_0 = 3$ bar

TM03 6532 4506

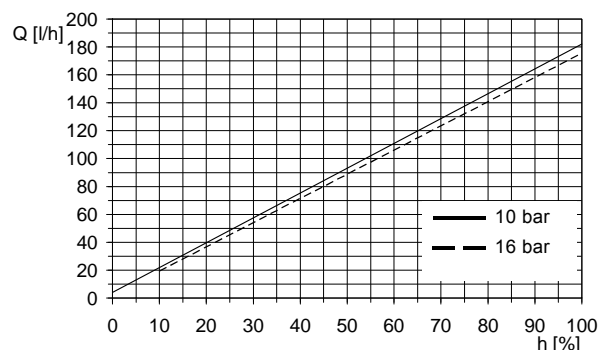

Fig. 103 DMH 136-16 (60 Hz), $Q_0 = 10$ bar

TM03 6536 4506

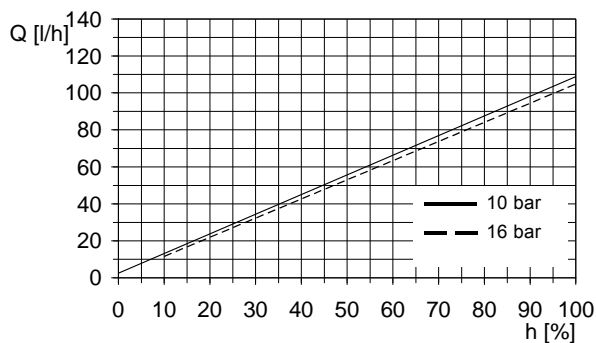

Fig. 100 DMH 97-16 (50 Hz), $Q_0 = 10$ bar

TM03 6533 4506

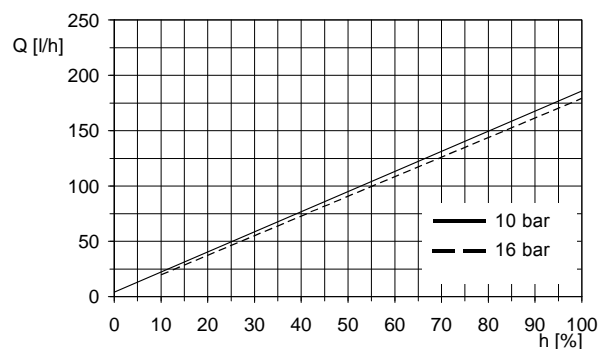

Fig. 104 DMH 166-16 (50 Hz), $Q_0 = 10$ bar

TM03 6537 4506

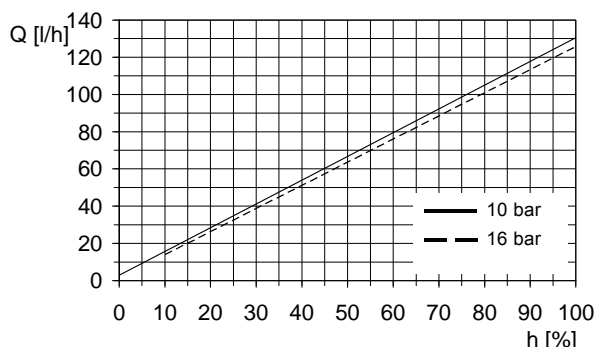

Fig. 101 DMH 97-16 (60 Hz), $Q_0 = 10$ bar

TM03 6534 4506

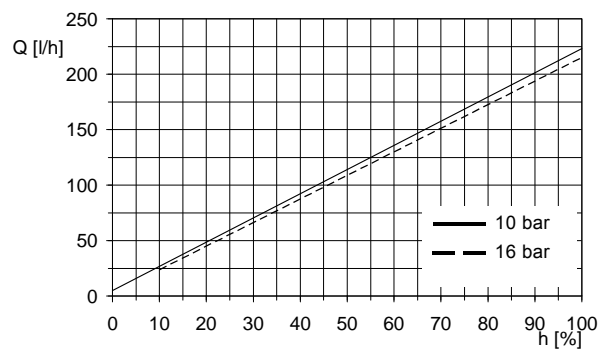

Fig. 105 DMH 166-16 (60 Hz), $Q_0 = 10$ bar

TM03 6538 4506

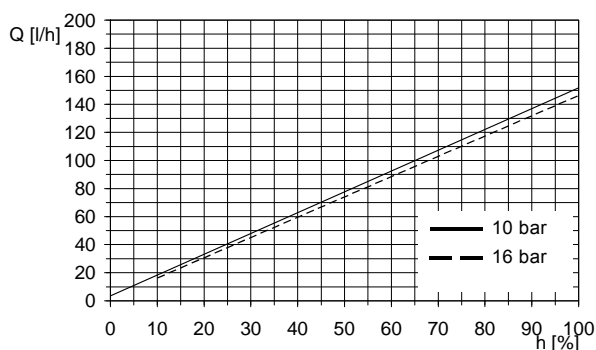

Fig. 102 DMH 136-16 (50 Hz), $Q_0 = 10$ bar

TM03 6535 4506

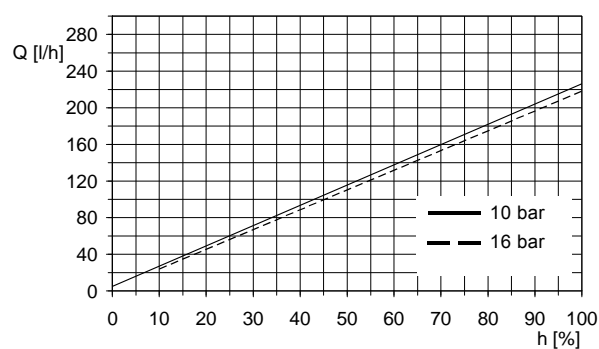

Fig. 106 DMH 202-16 (50 Hz), $Q_0 = 10$ bar

TM03 6539 4506

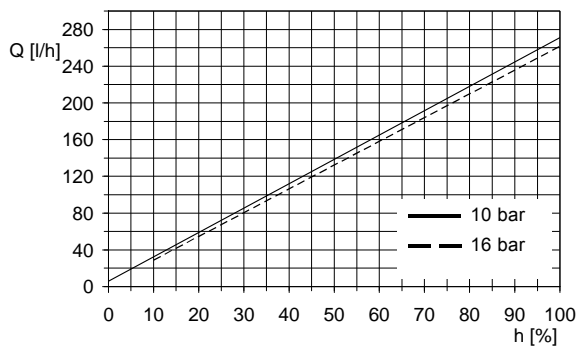

Fig. 107 DMH 202-16 (60 Hz), $Q_0 = 10$ bar

TM03 6540 4506

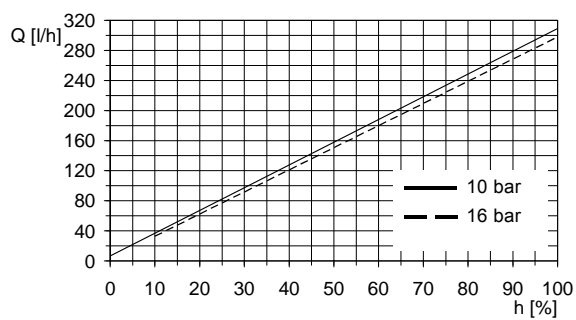
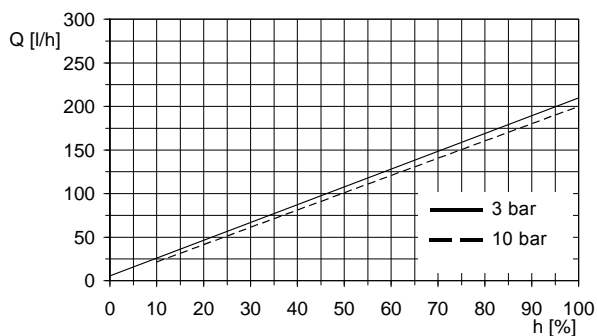

Fig. 108 DMH 276-16 (50 Hz), $Q_0 = 10$ bar

TM03 6541 4506

DMH 255



TM03 6542 4506

Fig. 109 DMH 194-10 (50 Hz), $Q_0 = 3$ bar

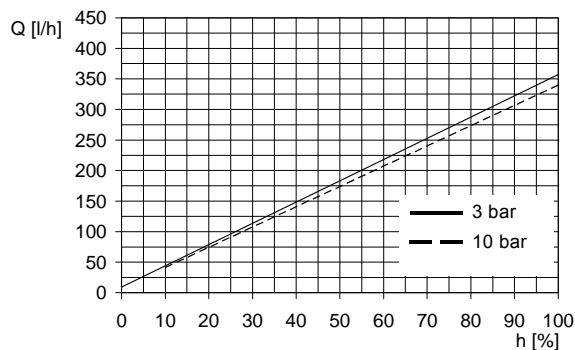

TM03 6546 4506

Fig. 113 DMH 332-10 (50 Hz), $Q_0 = 3$ bar

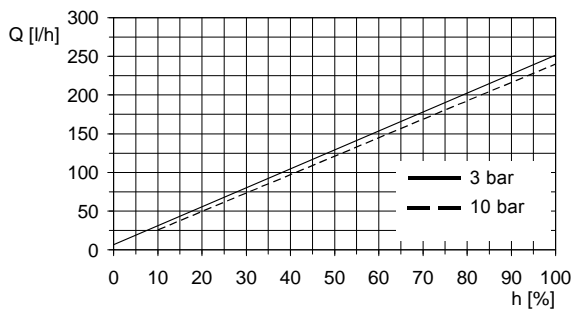

TM03 6543 4506

Fig. 110 DMH 194-10 (60 Hz), $Q_0 = 3$ bar

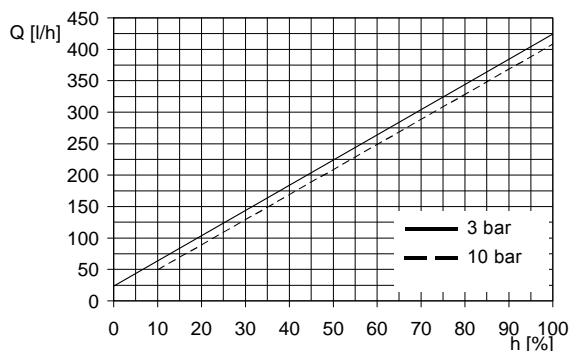

TM03 6547 4506

Fig. 114 DMH 332-10 (60 Hz), $Q_0 = 3$ bar

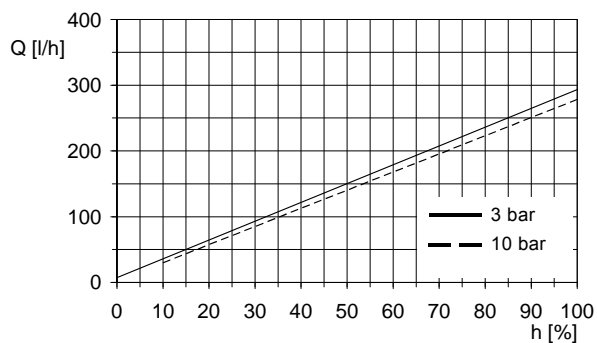

TM03 6544 4506

Fig. 111 DMH 270-10 (50 Hz), $Q_0 = 3$ bar

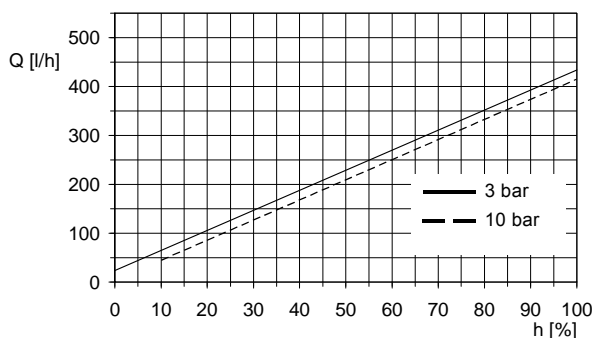

TM03 6548 4506

Fig. 115 DMH 403-10 (50 Hz), $Q_0 = 3$ bar

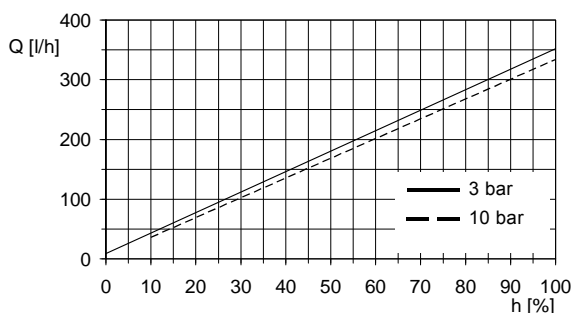

TM03 6545 4506

Fig. 112 DMH 270-10 (60 Hz), $Q_0 = 3$ bar

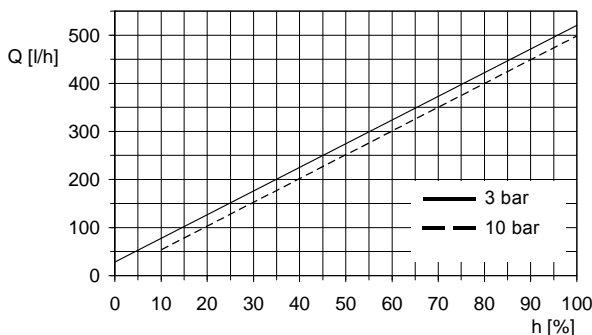

TM03 6549 4506

Fig. 116 DMH 403-10 (60 Hz), $Q_0 = 3$ bar

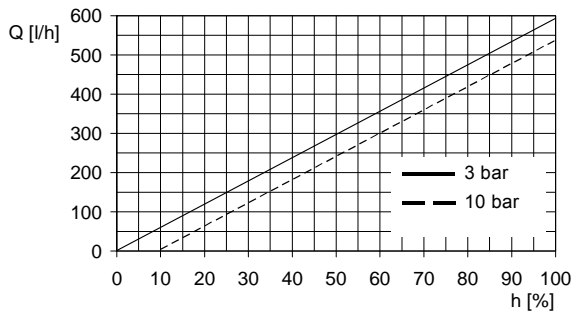

Fig. 117 DMH 550-10 (50 Hz), $Q_0 = 3$ bar

TM03 6550 4506

DMH 257

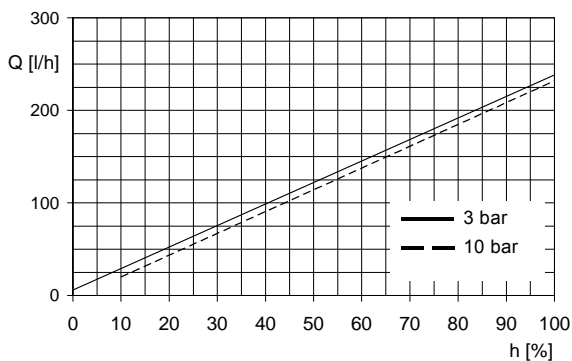

Fig. 118 DMH 220-10 (50 Hz), $Q_0 = 3$ bar

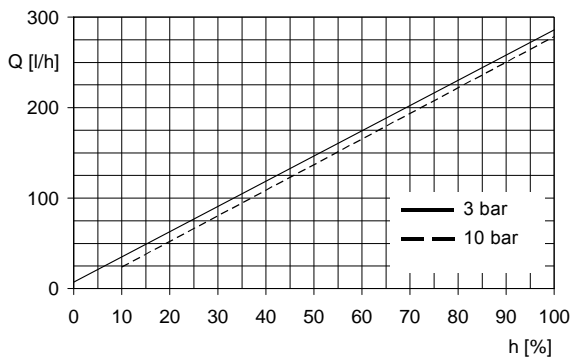

Fig. 119 DMH 220-10 (60 Hz), $Q_0 = 3$ bar

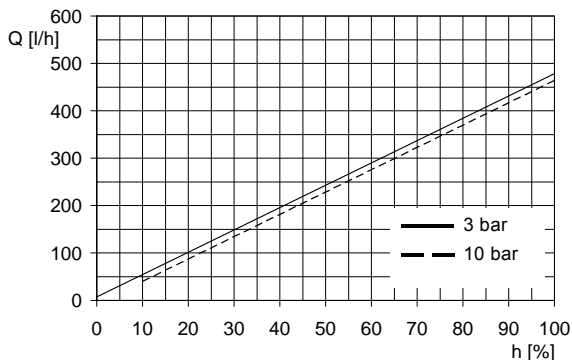

Fig. 120 DMH 440-10 (50 Hz), $Q_0 = 3$ bar

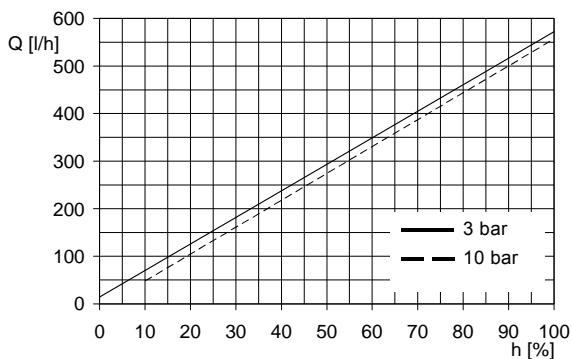

Fig. 121 DMH 440-10 (60 Hz), $Q_0 = 3$ bar

TM03 6551 4506

TM03 6552 4506

TM03 6553 4506

TM03 6554 4506

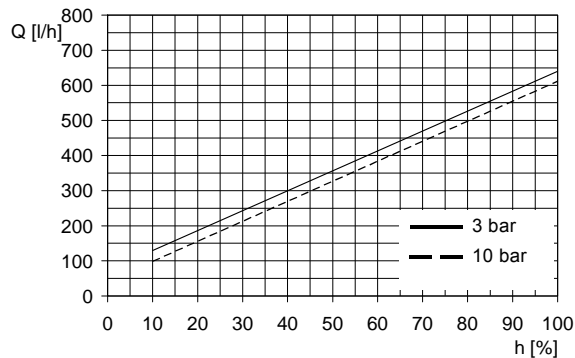

Fig. 122 DMH 575-10 (50 Hz), $Q_0 = 3$ bar

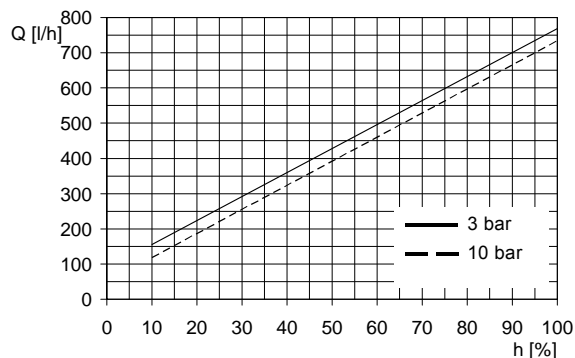

Fig. 123 DMH 575-10 (60 Hz), $Q_0 = 3$ bar

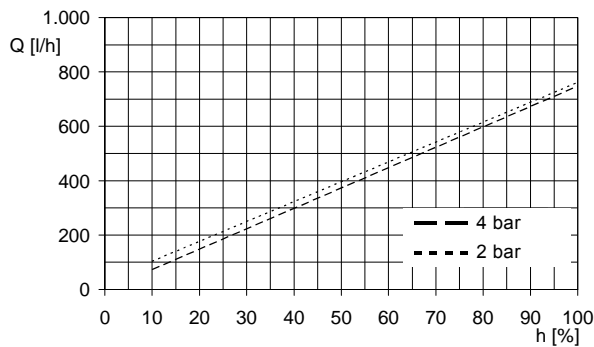

Fig. 124 DMH 750-4 (50 Hz), $Q_0 = 3$ bar

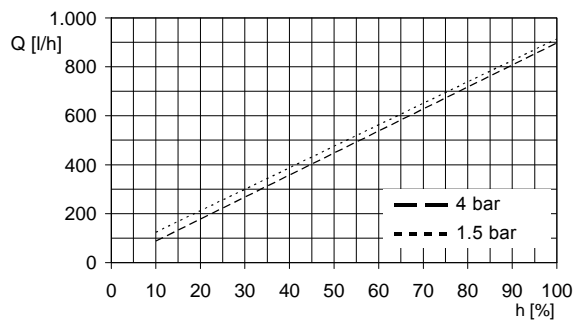

Fig. 125 DMH 750-4 (60 Hz), $Q_0 = 3$ bar

TM03 6555 4506

TM03 6556 4506

TM03 6557 4506

TM03 6558 4506

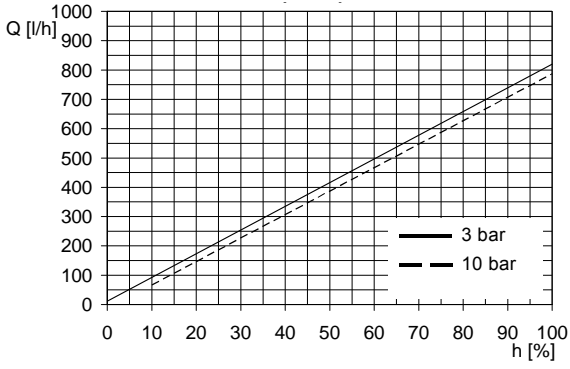

Fig. 126 DMH 770-10 (50 Hz), $Q_0 = 3$ bar

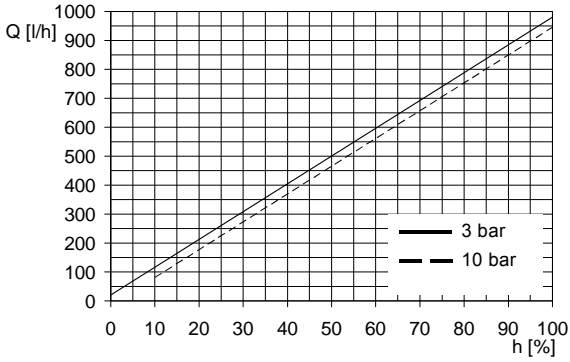

Fig. 127 DMH 770-10 (60 Hz), $Q_0 = 3$ bar

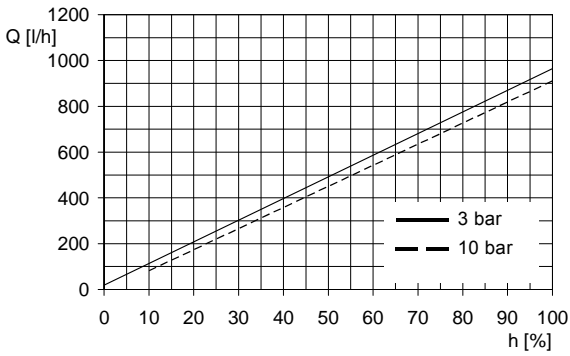

Fig. 128 DMH 880-10 (50 Hz), $Q_0 = 3$ bar

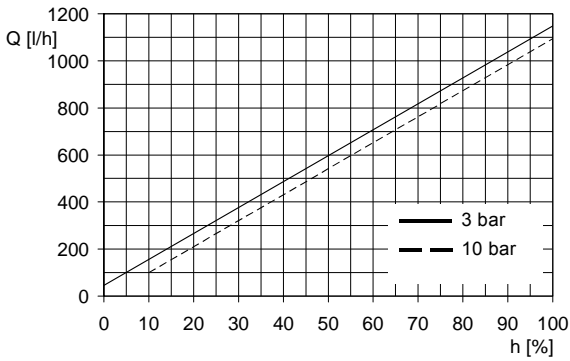

Fig. 129 DMH 880-10 (60 Hz), $Q_0 = 3$ bar

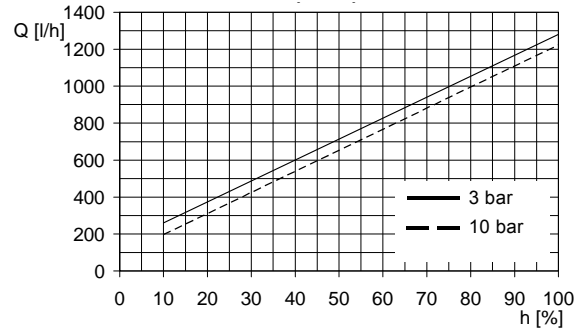

Fig. 130 DMH 1150-10 (50 Hz), $Q_0 = 3$ bar

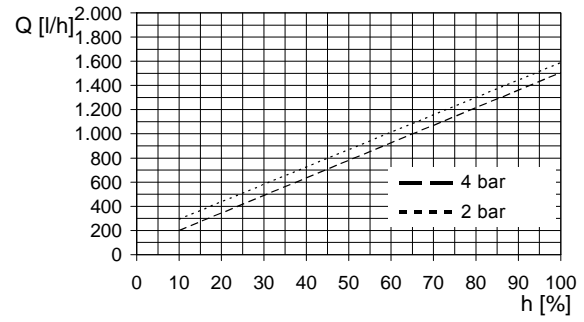

Fig. 131 DMH 1500-4 (50 Hz), $Q_0 = 3$ bar

TM03 6559 4506

TM03 6560 4506

TM03 6561 4506

TM03 6562 4506

TM03 6563 4506

TM03 6564 4506

16. Disposal

This product or parts of it must be disposed of in an environmentally sound way. Use appropriate waste collection services. If this is not possible, contact the nearest Grundfos company or service workshop.

Subject to alterations.

Safety declaration

Please copy, fill in and sign this sheet and attach it to the pump returned for service.

We hereby declare that this product is free from hazardous chemicals, biological and radioactive substances:

Product type: _____

Model number: _____

No media or water: _____

A chemical solution, name: _____

(see pump nameplate)

Fault description

Please make a circle around the damaged part.
In the case of an electrical or functional fault, please mark the cabinet.



GrA3467

Please give a short description of the fault:

Date and signature

Company stamp

96771725 0712

ECM: 1096869

The name Grundfos, the Grundfos logo, and the payoff Be-Think-Innovate are registered trademarks owned by Grundfos Management A/S or Grundfos A/S, Denmark. All rights reserved worldwide.