

50Hz

ARGAL

CHEMICAL PUMPS

Route range

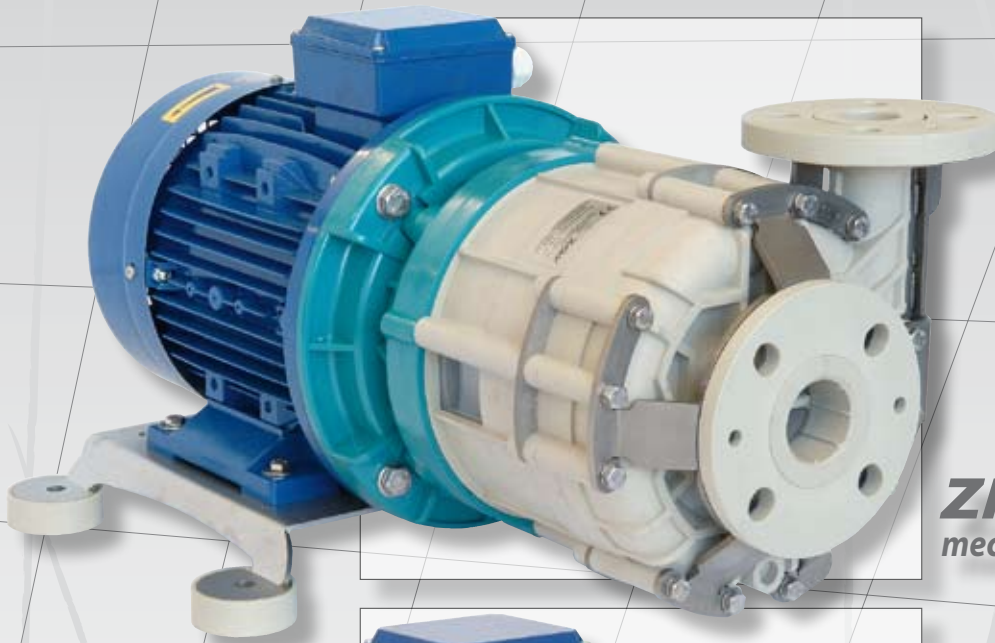

ZMR
mechanical sealed



TMR
magetical driven

**centrifugal pumps
in thermoplastic materials**

In this catalog Argal proposes the range of ROUTE pumps, inclusive of magnetical driven serie named **TMR** embedding innovative patented technology, and traditional mechanical sealed serie named **ZMR**.

ARGAL with these series, offers more than competitors a complete solutions to pump almost all the chemical liquids: aggressive, clean or with solid in suspension included lightly abrasives.

The advantages of these series are

- simple and innovative constructions
- suitability to transfer chemicals in industrial applications
- minimised maintenance
- no need of specialized after sales service centers
- affordable purchase price and low operative cost.

To improve existing technology our R&D department developed and patented a solution called "two axial directions self alignment system" that controls the movement of the impeller through additional magnetic field.

ARGAL exploited this innovative idea to its best eliminating almost all frictions (both front and rear) except the attrition of rotation; In absence of hydraulic flow the magnetic field of this new system pulls the impeller in a central neutral position: the tolerance to dry running of the pump with the "R" self lubricating guide system is therefore guaranteed.



Argal operates with ISO 9001:2000 Quality System certified by SQS-Iqnet.



Magnetic driven pump G3 size in reinforced polypropylene (WR).



PATENTED SYSTEM: THE PRINCIPLE OF TWO AXIAL DIRECTIONS SELF-ALIGNMENT SYSTEM

The impeller subjected to different hydraulic load is free to move axially.

Two rings which are limit devices of its excursion fix the work-space it engages during the standard operation. In case of anomalies due to pressure loss as dry running, the extra magnetic field (always active) contrasting the axial pushes, calls back the impeller in the neutral position.

This distinctive automatism precisely prevents the contact with the rings (limiting devices) and consequently avoids frictions and heat increase. The shape of the magnets and the orientation of the fields are the key that shows the desired action.

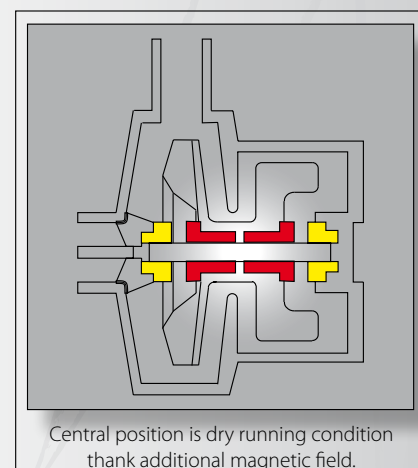
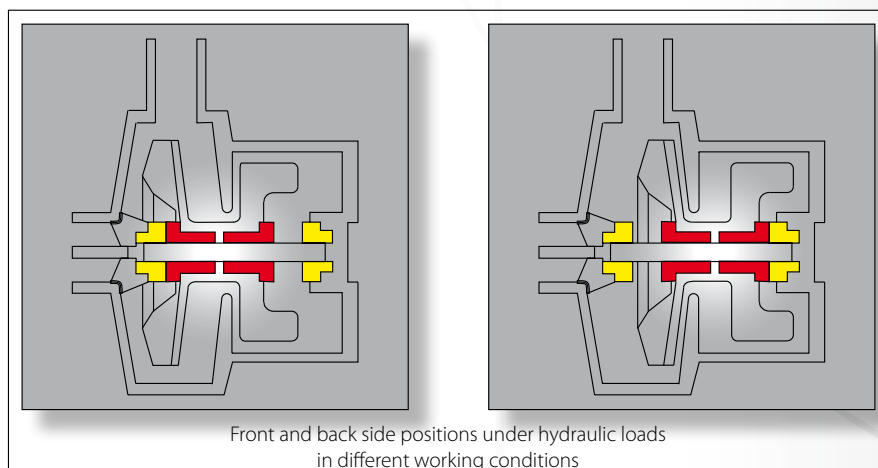

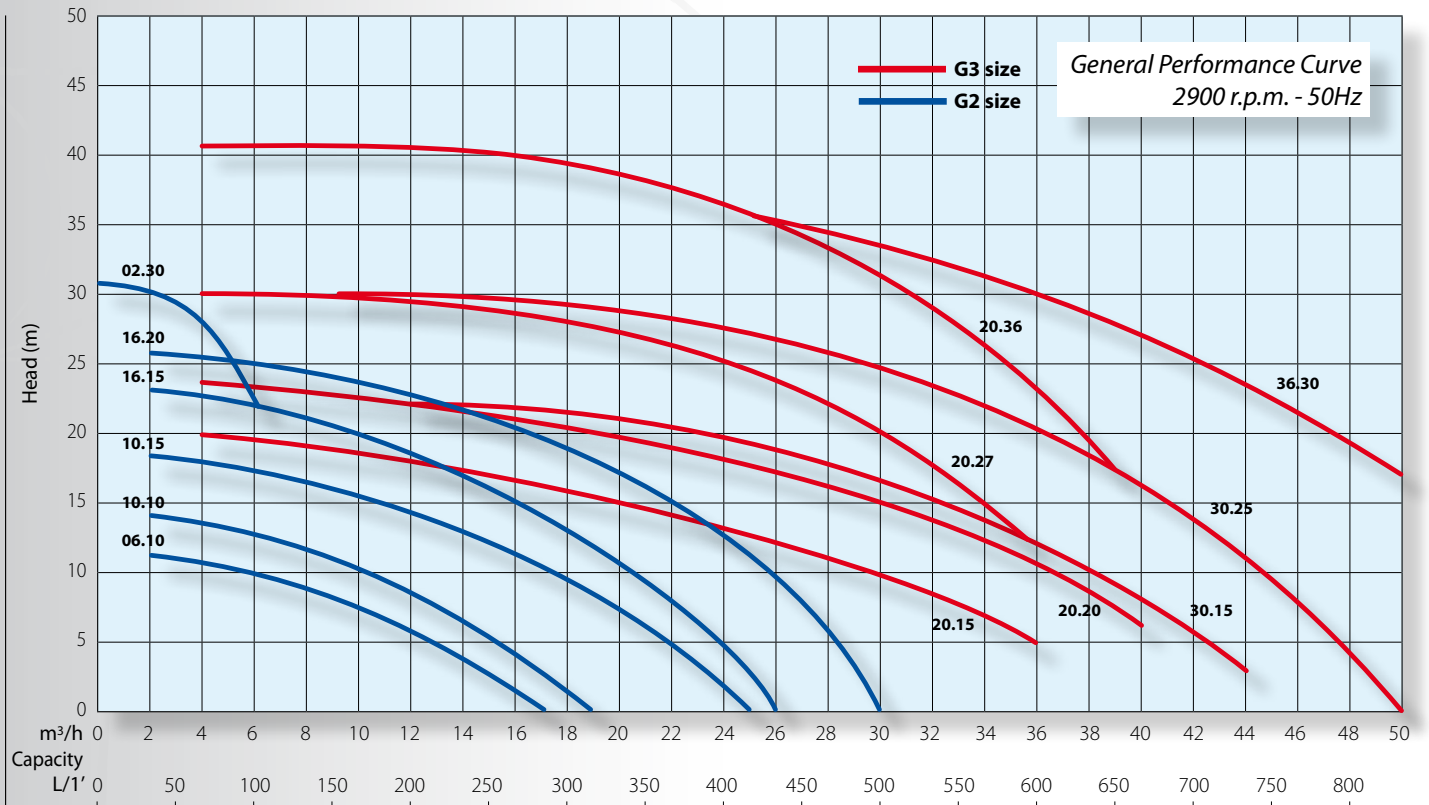

NOTES: All curves are referred to: water at 20°C - viscosity 1 °E - specific gravity 1 kg/dm² pt



View of Route range pumps in different materials and constructions.

Labels in this catalog

GFR/PP	Glass fibre reinforced Polypropylene (30%)	EPDM	Etylene-Propylene rubber
CFF/E-CTFE	Etylene-Chloro Trifluoro Etylene carbon fibre filled (20%)	BSP - m	BSP parallel threaded male connect. (according to ISO 7/1)
CARB. H.D.	Carbon high density	NPT - m	Threaded male NPT connections
SiC	Silicon Carbide	ND	Nominal diameter
CER	Alumina ceramic at 99,7%	ISO	Ref. Flange ISO 2084 - NP10
GFR/PTFE	Glass fibre reinforced PTFE	ANSI	Ref. Flange ANSI B 16.5 - Flat Face
FKM	Fluorine elastomer	IEC	According to E.C. motors
FFKM	Perfluorelastomer	NEMA	Accordind to U.S. motors

MAIN FEATURES OF SEAL-LESS MAGNETICAL DRIVEN “TMR”

HERMETIC PUMPS

The magnetical driven pumps are defined “hermetic” because of the exclusion of any rotating component of seal. The only necessity of seal between the volute casing and the back casing is guaranteed from a static gasket: O-ring type.

FOR ALL CHEMICALS

You can practically pump all the chemicals at low and medium temperatures with all the bodies in GFR-PP (glass fibre reinforced polypropylene) or CFF-E-CTFE (Etylene- Chloro TrifluoroEtylene carbon fibre filled).

• LOADED FLUIDS, LIGHTLY ABRASIVE

The different internal configurations of the materials allow to pump both clean fluids and mediums with solids in suspensions or moderately abrasive

• HEAVY FLUIDS

Strong magnetic coupling made up of rare-earth materials (Neodimium Iron Boron) and “N” (standard), “P” (powered) or “S” (strong-powered) versions allow to pump, also at maximum flow, liquids with 1.05 –1.35 – 1.8 specific gravity respectively.

DRY RUNNING OPERATION

Dry running conditions with guide bushings in Carbon HD is guaranteed without damages thanks to the “two axial directions self-alignment” system (models 20.36 - 36.30 excluded). The conformation of the industrial plant, the fluid presence or absence in the pump body and its nature, affect the lenght of the dry running phase without damages or anomalous wear. All these details are listed in special time tables in the pumps manual.

POSSIBLE ROTATION OF VOLUTE CASING

Various shifts of the volute casing can be obtained thanks to rotation. The joint of the outlet connection of the pump with the tube of the plant is made easier.

CENTRIFUGAL IMPELLER PROPERLY BALANCED

Thanks to particular hydraulic and structural changes, the impeller is effectively balanced in order to reduce the assistance for maintenance. The separability of the bladed part from the one containing all magnets with driving and axial control, a significant amount of money is saved in case of impeller substitution (only G3 size).

VARIOUS TYPOLOGIES OF CONNECTIONS

Connections with BSP cylindrical thread or NPT; flanges ISO, ANSI, JIS.

INDEPENDENT MOTOR APPLICATION

The motor can be installed and removed easily without dismantling or opening the volute casing. Standard motors are IEC or NEMA.

VOLUTE CASING DRAINING

Draining connection is arranged and it is available upon request.

GUARD PLATE

A stainless steel guard plate is designed and fitted onto all models in order to protect the front casing from accidental mechanical shocks of various nature (e.g.: starts up with vacuum in inlet piping with possible piping excursions due to elastic brackets or thermal elongation). The guard plate is optional for G2 size of pumps.

BASE AVAILABILITY

The base for anchorage of the pump is in stainless steel with ground terminals in chemical-resistant thermoplastic materials. It is supplied upon request.

PREPARATIONS OF G2 SIZE

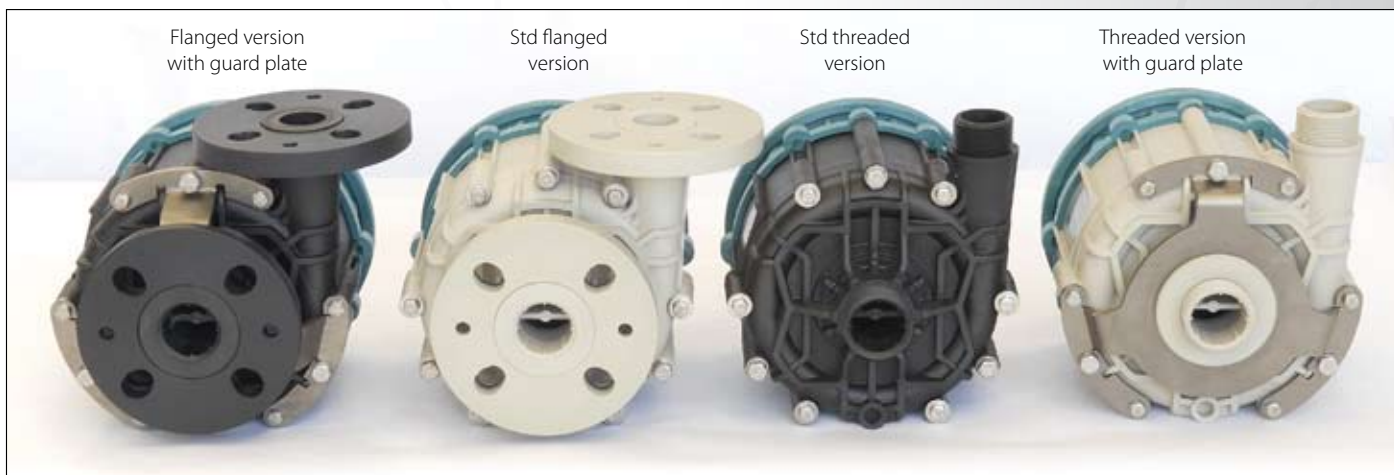

THE MATERIALS

table 1

VERSION	REINFORCED POLYMERS	MIN. TEMP.	MAX TEMP.	ENVIRONMENT TEMP.
WR	GFR/PP	-5°C (23°F)	80°C (176°F)	0÷40°C (14÷104°F)
GF	CFF/E-CTFE	-20°C (-4°F)	100°C (212°F)	-20÷40°C (-4÷104°F)
GX*	CFF/E-CTFE	-20°C (-4°F)	100°C (212°F)	-20÷40°C (-4÷104°F)

Note: Maximum inlet pressure: 1,5 bar - (*) Compliant to ATEX 94/9/EC regulations

THE CONSTRUCTIONS

table 2

TMR (G2 - G3 sizes)	WR	GF	GX*
Volute casing	GFR/PP	CFF/E-CTFE	CFF/E-CTFE
Rear casing			
Centrifugal impeller			
OR gasket	FKM (1)	FKM (1); (2)	FKM (1); (2)

Upon request: (1) EPDM - (2) FFKM - (*) Compliant to ATEX 94/9/EC regulations

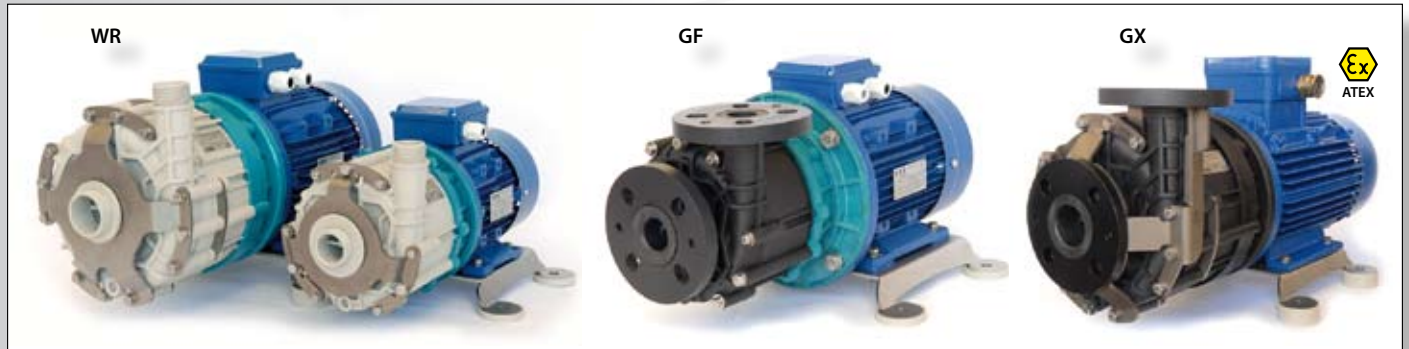

GUIDE SYSTEMS

table 3

TMR (G2 - G3 sizes)	R1	X1	N1	R2	X2	N2	R2	N2
Guide bushing	Carbon HD	SiC	GFR/PTFE	Carbon HD	SiC	GFR/PTFE	Carbon HD	GFR/PTFE
Thrust bush		CER			SiC			SiC
Shaft		CER			SiC			SiC



11 - R2 guide system (G2 size)

12 - X1 guide system (G3 size)

TMR - SECTION VIEW (G3 size)

- 1 - Volute casing
- 2 - Centrifugal impeller (covered type)
- 3 - Centrifugal impeller (magnetic part)
- 4 - Central disk
- 5 - Rear casing
- 6 - OR gasket
- 7 - Drive magnet assembly
- 8 - Bracket
- 9 - Motor adapter
- 10 - Guard plate

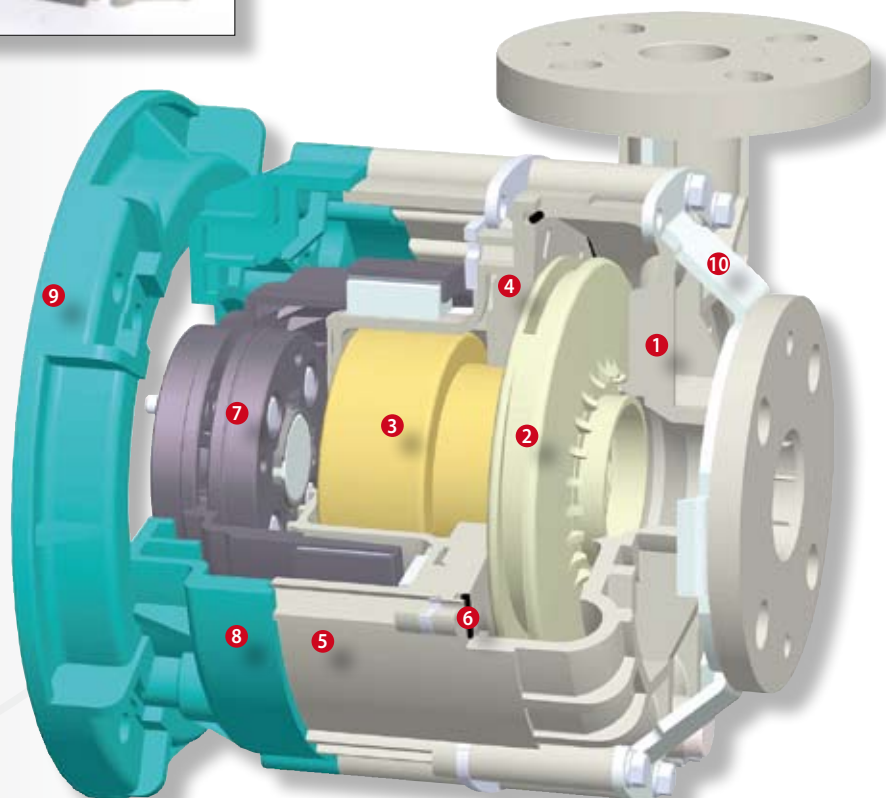

MAIN FEATURES OF MECHANICAL SEALED "ZMR"

VARIOUS TYPES OF MECHANICAL SEALS FOR ALL CHEMICALS

Different types of mechanical seals are available, single lubricated by pumped liquid or with flushing systems with liquid from the outside. Thanks to bodies in GFR-PP (glass fibre-reinforced polypropylene) or in CFF-E-CTFE (Etylene-ChloroTrifluoroEtylene carbon fibre filled) all chemicals at low and medium temperatures can be pumped.

The different combinations of materials of the sliding counter-face of the mechanical seal allow to pump liquids with solids in suspensions or abrasive. Various electrical powers are available in the "N" (standard) "P" (powered) or "S" (strong-powered) versions. They allow to pump, also at maximum flow, liquids with 1,05 – 1,35 – 1,8 specific gravity respectively.

POSSIBLE ROTATION OF VOLUTE CASING

Various shifts of the volute casing can be obtained thanks to rotation. The joint of the outlet connection of the pump with the tube of the plant is made easier.

VARIOUS TYPOLOGIES OF CONNECTIONS

Connections with BSP cylindrical thread or NPT; flanges ISO, ANSI, JIS.

ELECTRICAL MOTORS

IEC or NEMA standard motors can be installed.

GUARD PLATE

A stainless steel guard plate is designed and fitted onto all models in order to protect the front casing from accidental mechanical shocks of various nature (e.g.: starts up with vacuum in inlet piping with possible piping excursions due to elastic brackets or thermal elongation). The guard plate is optional for G2 size of pumps.

BASE AND VOLUTE CASING DRAINING are available upon request.

ZMR CONSTRUCTIONS (G2 - G3 sizes)

table 4

VERSION	WR	GF	GX*
Volute casing	GFR/PP		CFF/E-CTFE
Rear casing			
Centrifugal impeller			
OR gasket	FKM (1)		FKM (1); (2)

Note: Maximum inlet pressure: 1,5 bar - Upon request: (1) EPDM or (2) FFKM - (*) Compliant to ATEX 94/9/EC regulations

Mechanical sealed
Route ZMR G3 size pump
in PP reinforced material (WR)



Mechanical sealed
Route ZMR G2 size pump
in E-CTFE reinforced material (GF)

THE CONSTRUCTIONS OF MECHANICAL SEALS

table 5

construction	model	rotating part	fixed ring	bellow	2nd rotating part	2nd fixed part	WORKING CONDITIONS
INTERNAL SINGLE	BS5*	CARBON	CER	FKM			LOW COST (easy maintenance)
	BS7*		SiC				
	BS6*	SiC	CER				HARD PARTICLES
	BF3**		SiC				
EXTERNAL SINGLE	SF1	GFR/PTFE	CER	PTFE	CARBON	CER	NORMAL USE
	SF2		SiC				
	TS5	CARBON	CER	FKM			
	TS7		SiC				
	TS6	SiC	CER				
	TS8		SiC				
	DOUBLE	MSF1	GFR/PTFE	CER			PTFE
MSF2		SiC		HARD PARTICLES			
MTS5		CARBON	CER		FKM		
MTS7			SiC				
MTS6		SiC	CER				
MTS8			SiC				

(*) To use up to 50 °C liquid temp. - (**) Only for ZMR G3 size

SECTIONS OF VARIOUS KIND OF MECHANICAL SEALS

BS5 - BS6 - BS7

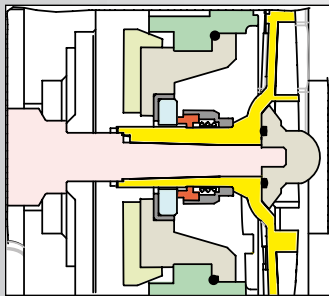

SF1 - SF2

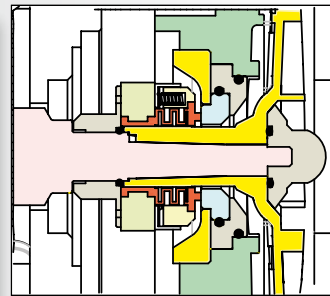

TS5 - TS6 - TS7 - TS8



MSF_ - MTS_

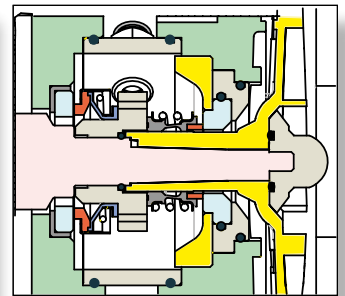

ZMR - SECTION VIEW (G3 size)

- 1 - Volute casing
- 2 - Centrifugal impeller (open type)
- 3 - Ogive
- 4 - Rear casing
- 5 - Diaphragm
- 6 - Internal mechanical seal
- 7 - Sleeve shaft
- 8 - Counter plate
- 9 - Shaft
- 10 - Dividing plate
- 11 - Bracket
- 12 - Motor adapter
- 13 - Guard plate

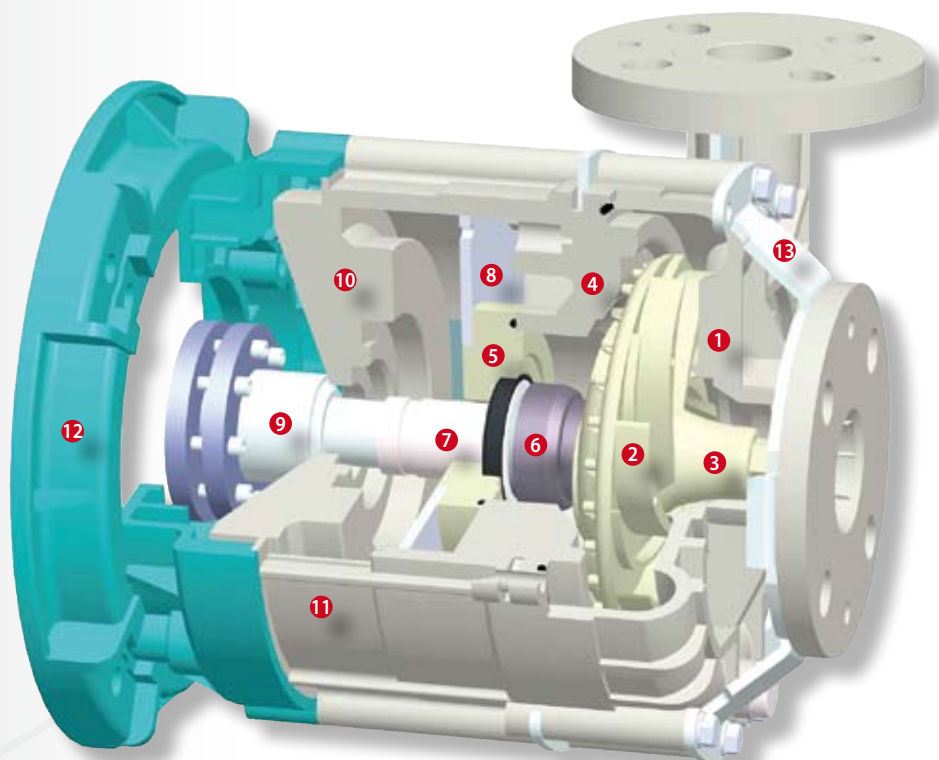

PUMP SPECIFICATIONS (G2 - G3 sizes)

table 6

TMR - ZMR	50Hz	All models (G2 size)	All models (G3 size)
∅ Inlet	BSP	1 1/2"	2"
∅ Outlet	BSP	1 1/4"	1 1/2"
∅ Inlet	NPT	1 1/2"	2"
∅ Outlet	NPT	1 1/4"	1 1/2"
ISO flange	DNA (mm)	40	50
	DNM (mm)	32 (40*)	40
ANSI flange	DNA (Inch)	1 1/2"	2"
	DNM (Inch)	1 1/4" (1 1/2"*)	1 1/2"
JIS flange	DNA (Inch)	1 1/2"	2"
	DNM (Inch)	1 1/4" (1 1/2"*)	1 1/2"

(*) Available on request

MOTOR SPECIFICATIONS (G2 size)

table 7

		06.10			10.10			10.15			16.15			16.20			02.30		
		N	P	S	N	P	S	N	P	S	N	P	S	N	P	S	N	P	S
Power (IEC) 50 Hz	kW	0,55	0,75	1,1	0,75	1,1	1,5	1,1	1,5	2,2	1,5	2,2	3	2,2	3	4*	2,2	3	4*
Motor size	IEC	71	80A	80B	80A	80B	90S	80B	90S	90L	90S	90L	100	90L	100	112	90L	100	112
Phases	N.	3phase (all models) - 1phase (< 3 kW)																	
Std. voltage (IEC)	V	400 ± 5% 50Hz - 220 ± 5% 50Hz																	
Motor protection	IP	55																	

(*) ZMR only

WEIGHT (G2 size)

table 8

Pump weight (without motor)			Motor weight															
WR	GF	GX	Version	IEC 3phase						IEC 3phase E-exd								
4	5		Frame	71	80A	80B	90S	90L	100	112*	71	80A	80B	90S	90L	100	112*	
			Kg	7	8	10	13	17	22	31	15	20	20	30	31	41	65	

(*) ZMR only

MOTOR SPECIFICATIONS (G3 size)

table 9

		20.15			20.20			20.27			20.36			30.15			30.25			36.30		
		N	P	S	N	P	S	N	P	S	N	P	S	N	P	S	N	P	S	N	P	S
Power (IEC) 50 Hz	kW	2,2	3	4	3	4	5,5	4	5,5	7,5	5,5	7,5	11	4	5,5	7,5	5,5	7,5	11	7,5	11	15*
Motor size	IEC	90L	100L	112M	100L	112M	132SA	112M	132SA	132SB	132SA	132SB	160MA	112M	132SA	132SB	132SA	132SB	160MA	132SB	160MA	160MB
Phases	N.	3phase																				
Std. voltage (IEC)	V	400 ± 5% 50Hz																				
Motor protection	IP	55																				

(*) ZMR only

WEIGHT (G3 size)

table 10

Pump weight (without motor)			Motor weight															
WR	GF	GX	Version	IEC 3phase						IEC 3phase E-exd								
12 (TMR) 8 (ZMR)	13 (TMR) 9 (ZMR)		Frame	90L	100L	112M	132SA	132SB	160MA	160MB	90L	100L	112M	132SA	132SB	160MA	160MB	
			Kg	17	22	31	53	61	75	85	31	41	65	80	80	155	155	

"BSP" outlet cylindrical threaded connection

Detail of outlet flanged connection directly to the plant flange

View of stainless steel reinforced flat-face flange connections



2900 r.p.m. 50Hz



In the magnetical execution the motor is easily installed without disassembling the wet-end.

06.10

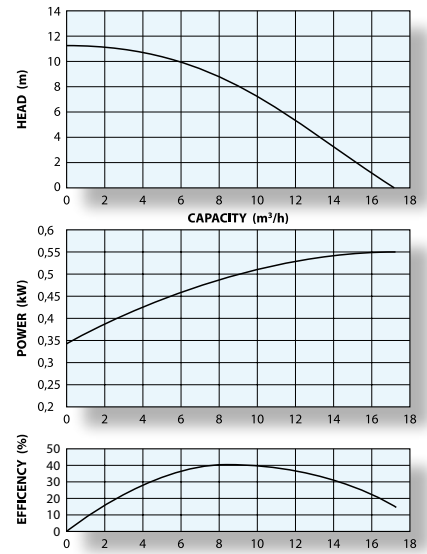

10.10

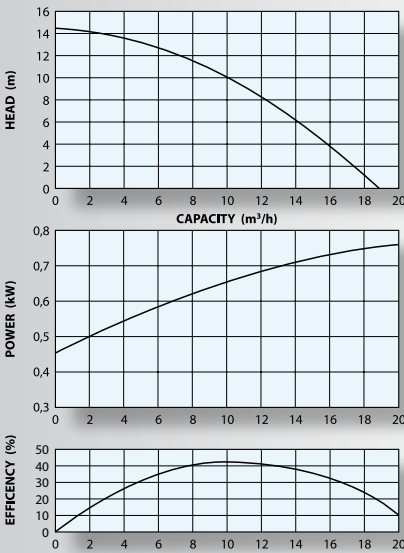

10.15

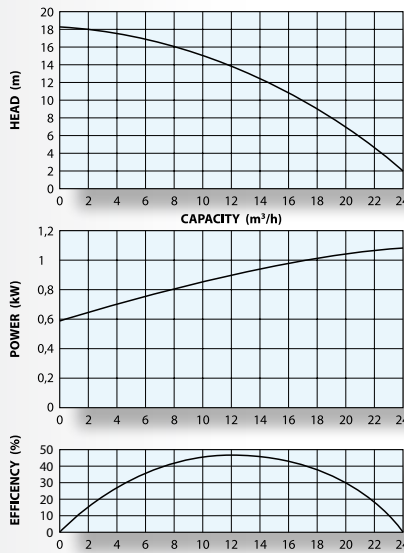

16.15

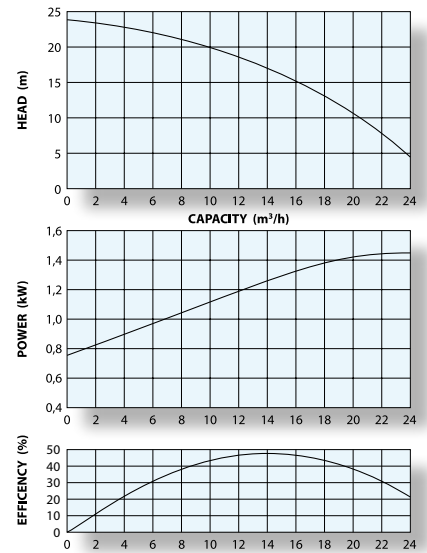

16.20

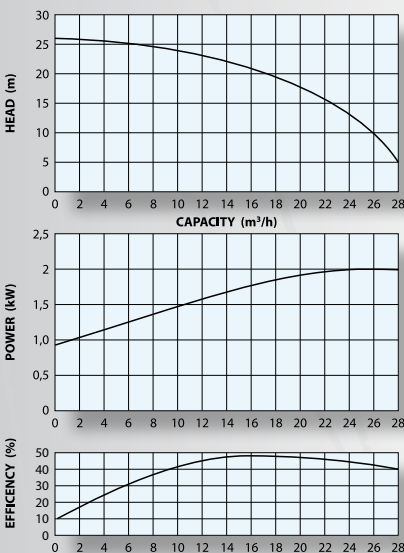

02.30

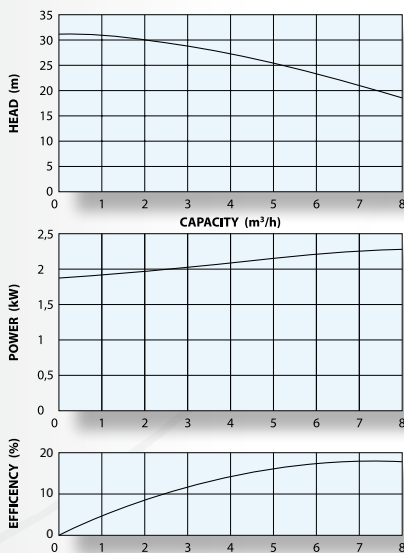

20.15

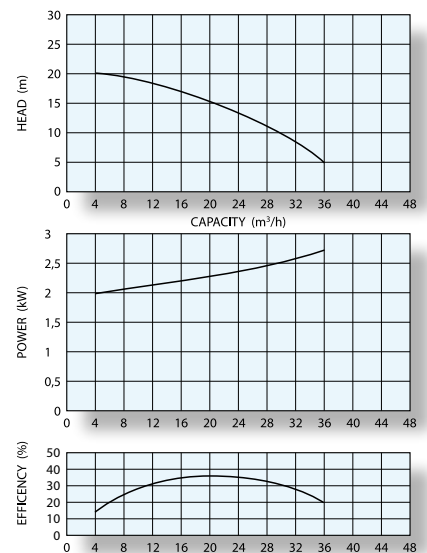

2900 r.p.m. 50Hz

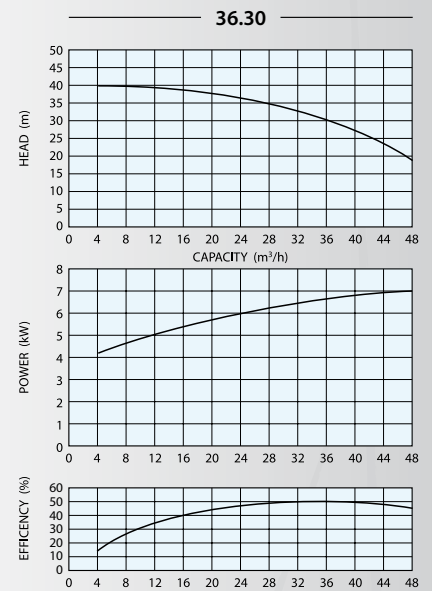
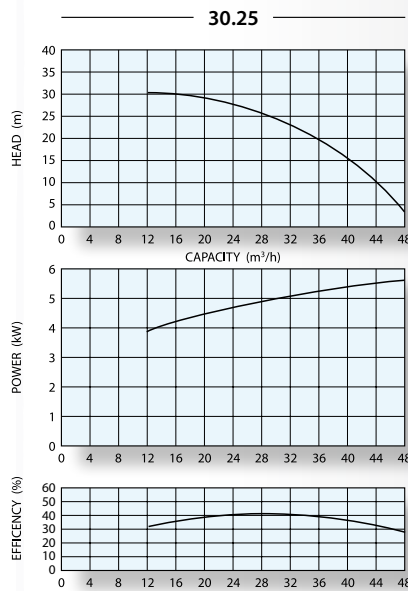
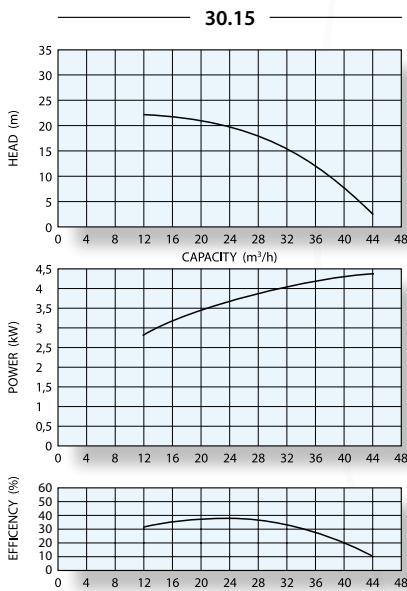
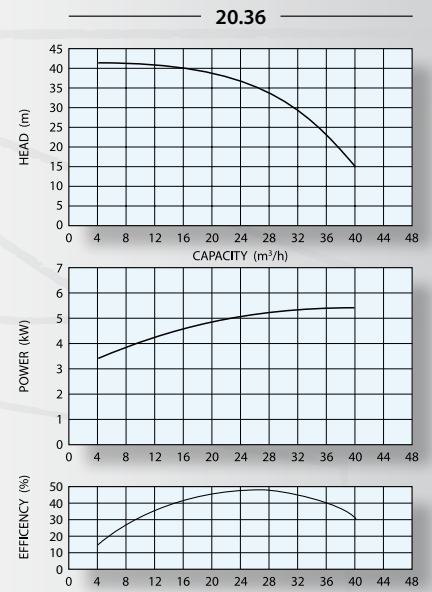
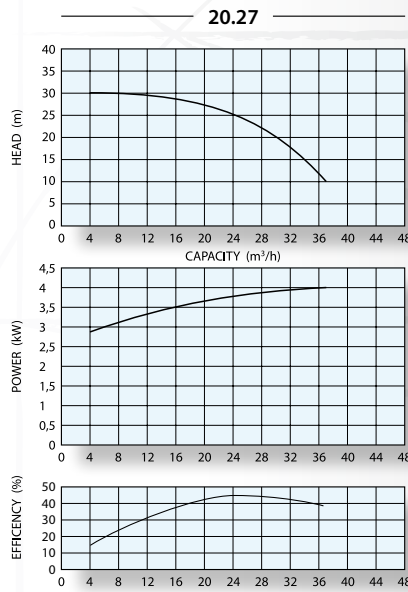
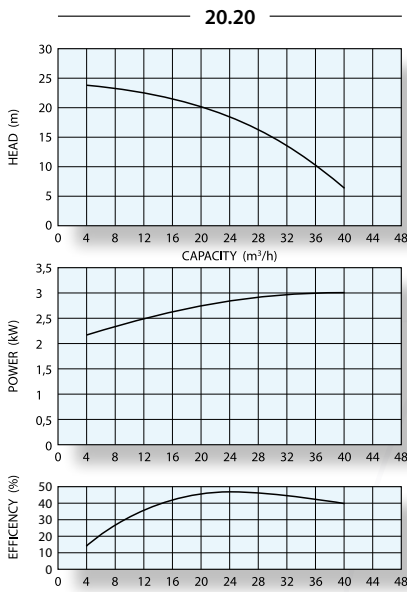

PUMP IDENTIFICATION LABEL

table 11

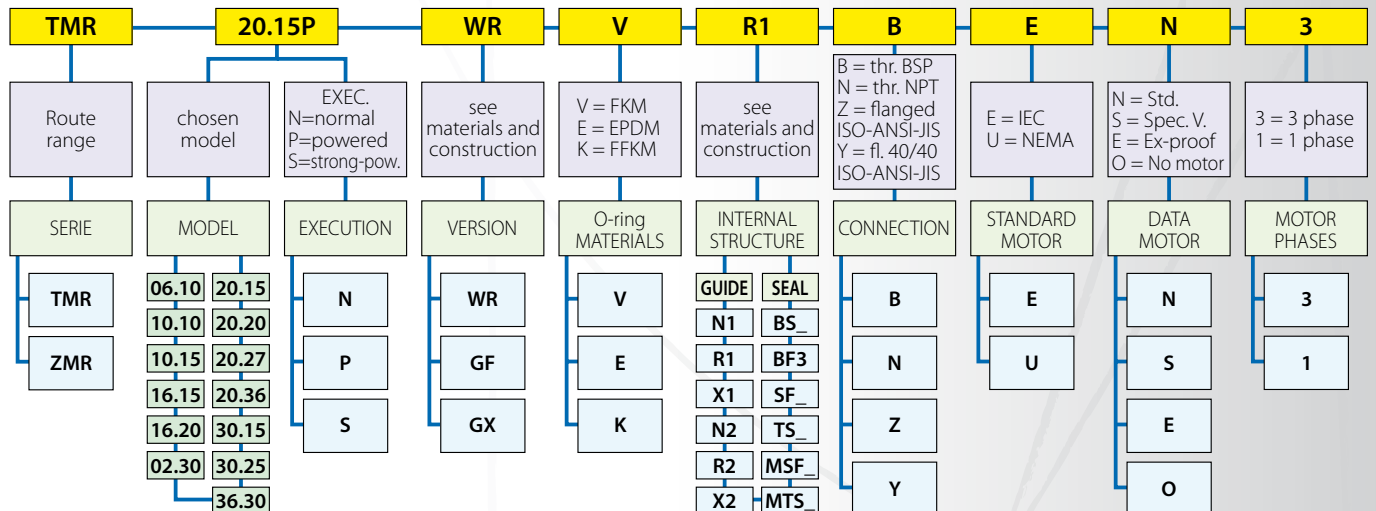

DIMENSIONS WITH IEC MOTORS - 50 Hz

table 12

size	model	IEC frame	DnA	DnM	DeA	DeM	KA iso./ansi./jis	KM iso./ansi./jis	d x z iso./ansi./jis	a1	L(°)		Q	h1	h2	r		r1		rb		m1	n1	s1	g(°)	L3	B2	S2	L1	B3	h3										
											TMR	ZMR				TMR	ZMR	TMR	ZMR																						
G2	06.10	N	71	40 - 1 1/2"	32 - 1 1/4"	1 1/2"	1 1/4"	110 / 98 / 105	100 / 89 / 100	18 x 4 / 16 x 4 / 19 x 4	67	356	364	71	80	194	202	149	157	161	169	90	112	7	106	185	248	14	245	308	40										
		P	80A																													385	393	199	207	100	125	110			
		S	80B																																						
	10.10	N	80A									405	413			90	205					213	149	157	161							169	140	140	8	142	185	248	14	245	308
		P	80B																																						
		S	90S																																						
	10.15	N	80B									405	413			80	199					207	149	157	161							169	125	140	142	185	248	14	245	308	
		P	90S																																						
		S	90L																																						
	16.15	N	90S									405	413			90	205					213	149	157	161							169	100	140	142	205	305	14	245	308	
		P	90L																																						
		S	100																																						
	16.20	N	90L									478	486			100	227					235	164	172	176							184	140	160	10	155	205	305	14	259	359
		P	90L																																						
		S	100																																						
	02.30*	N	90L									430	438			90	205					213	149	157	161							169	125	140	8	142	185	248	14	245	308
		P	100																																						
		S	112(°)																																						

(*) 02.30 close impeller in all ranges

DIMENSIONS WITH IEC MOTORS - 50 Hz

table 13

size	model	IEC frame	DnA	DnM	DeA	DeM	KA iso./ansi./jis	KM iso./ansi./jis	d x z iso./ansi./jis	a1	L(°)		Q	h1	h2	r		r1		rb		m1	n1	s1	g(°)	L3	B2	S2	L1	B3	h3		
											TMR	ZMR				TMR	ZMR	TMR	ZMR														
G3	20.15	N	90L	50 - 2"	40 - 1 1/2"	2"	1 1/2"	125 / 121 / 120	110 / 98 / 105	18 x 4 / 16 - 19 x 4 / 19 x 4	70	469	515	90	100	244	290	188	234	200	246	125	140	8	142	185	248	14	245	308			
		P	100L																												512	558	261
		S	112M																														
	20.20	N	100L									512	558			100	261	307	198	244	217	256	140	160	155	205	305	14	265	365			
		P	112M																														
		S	132SA																														
	20.27	N	112M									521	567			112	268	314	198	244	217	256	216	190	168	205	305	14	265	365			
		P	132SA																														
		S	132SB																														
	20.36	N	132SA									578	624			132	307	353	218	264	235	282	210	254	14	215	335	405	14	333	429		
		P	132SB																														
		S	160MA																														
	30.15	N	112M									743	864			160	356	402	248	294	265	312	210	254	14	215	335	405	14	405	475		
		P	132SA																														
		S	132SB																														
	30.25	N	132SA									578	624			132	307	343	218	264	235	282	140	216	10	181	263	359	14	333	429		
		P	132SB																														
		S	160MA																														
36.30	N	132SB	743	864	160	356	402	248	294	265	312	210	254	14	215	335	405	14	405	475													
	P	160MA																															
	S	160MB(°)																															

(°) can change for motors of different brands - (°) only ZMR

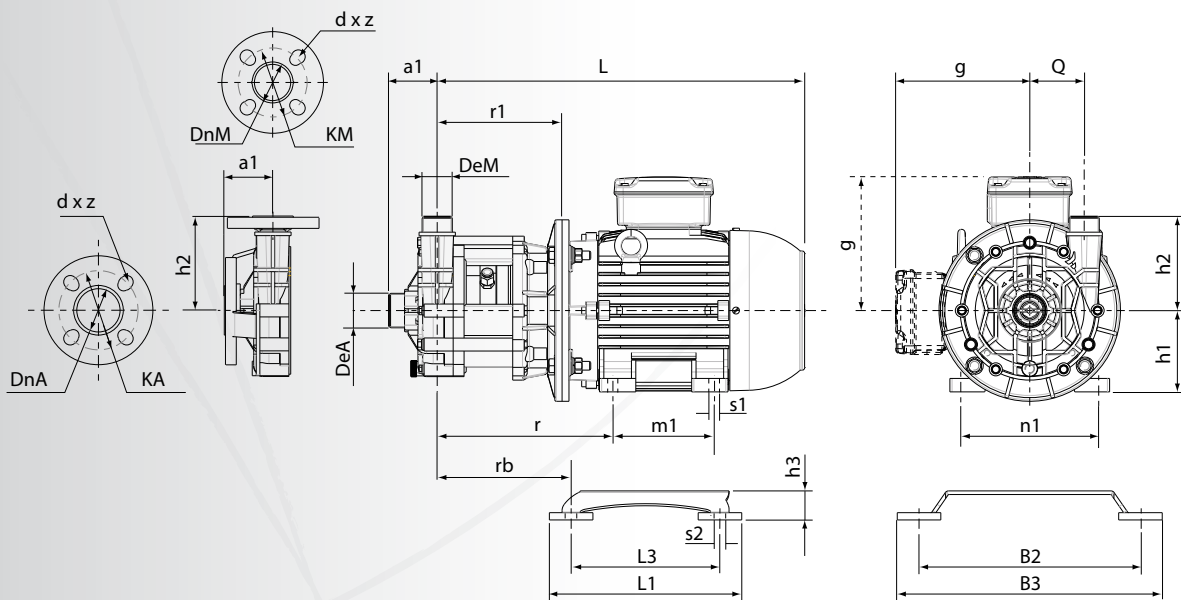

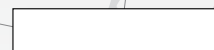

Member of AIB
associazione
industriale
Bresciana

Via Labirinto, 159 - 25125 BRESCIA - ITALY
Tel. +39.030.3507011 - Fax +39.030.3507077 - Export dpt. Tel. +39.030.3507033
Web: www.argal.it - E-mail: export@argal.it

*It is the policy of ARGAL to always improve its products and the right is reserved to alter specifications at any time without prior notice.
No part of this publication may be reproduced in any form or any means.*