

MP 1

Installation and operating instructions

GB D F I DK RU



GB Declaration of Conformity

We **Grundfos** declare under our sole responsibility that the product **MP 1**, to which this declaration relates, is in conformity with these Council Directives on the approximation of the laws of the EC Member States:

- Machinery Directive (98/37/EC).
- Low Voltage Directive (2006/95/EC).
Standards used: EN 61800-5-1: 2003, EN 61800-2: 1998 and EN 50529: 1992.
- EMC Directive (2004/108/EC).
Standards used: EN 61800-3: 2004, EN 55011: 1998, EN 55011-A1: 1999 and EN 55011-A2: 2002.

D Konformitätserklärung

Wir, **Grundfos**, erklären in alleiniger Verantwortung, dass das Produkt **MP 1**, auf das sich diese Erklärung bezieht, mit den folgenden Richtlinien des Rates zur Angleichung der Rechtsvorschriften der EU-Mitgliedsstaaten übereinstimmt:

- Maschinenrichtlinie (98/37/EG).
- Niederspannungsrichtlinie (2006/95/EG).
Normen, die verwendet wurden: EN 61800-5-1: 2003, EN 61800-2: 1998 und EN 50529: 1992.
- EMV-Richtlinie (2004/108/EG).
Normen, die verwendet wurden: EN 61800-3: 2004, EN 55011: 1998, EN 55011-A1: 1999 und EN 55011-A2: 2002.

F Déclaration de Conformité

Nous, **Grundfos**, déclarons sous notre seule responsabilité, que le produit **MP 1**, auquel se réfère cette déclaration, est conforme aux Directives du Conseil concernant le rapprochement des législations des Etats membres CE relatives aux normes énoncées ci-dessous :

- Directive Machines (98/37/CE).
- Directive Basse Tension (2006/95/CE).
Normes utilisées : EN 61800-5-1: 2003, EN 61800-2: 1998 et EN 50529: 1992.
- Directive Compatibilité Electromagnétique CEM (2004/108/CE).
Normes utilisées : EN 61800-3: 2004, EN 55011: 1998, EN 55011-A1: 1999 et EN 55011-A2: 2002.

I Dichiarazione di Conformità

Grundfos dichiara sotto la sua esclusiva responsabilità che il prodotto **MP 1**, al quale si riferisce questa dichiarazione, è conforme alle seguenti direttive del Consiglio riguardanti il riavvicinamento delle legislazioni degli Stati membri CE:

- Direttiva Macchine (98/37/CE).
- Direttiva Bassa Tensione (2006/95/CE).
Norme applicate: EN 61800-5-1: 2003, EN 61800-2: 1998 e EN 50529: 1992.
- Direttiva EMC (2004/108/CE).
Norme applicate: EN 61800-3: 2004, EN 55011: 1998, EN 55011-A1: 1999 e EN 55011-A2: 2002.

DK Overensstemmelseserklæring

Vi, **Grundfos**, erklærer under ansvar at produktet **MP 1** som denne erklæring omhandler, er i overensstemmelse med disse af Rådets direktiver om indbyrdes tilnærmelse til EF-medlemsstaternes lovgivning:

- Maskindirektivet (98/37/EF).
- Lavspændingsdirektivet (2006/95/EF).
Anvendte standarder: EN 61800-5-1: 2003, EN 61800-2: 1998 og EN 50529: 1992.
- EMC-direktivet (2004/108/EF).
Anvendte standarder: EN 61800-3: 2004, EN 55011: 1998, EN 55011-A1: 1999 og EN 55011-A2: 2002.

RU Декларация о соответствии

Мы, компания **Grundfos**, со всей ответственностью заявляем, что изделия **MP 1**, к которым относится настоящая декларация, соответствуют следующим Директивам Совета Евросоюза об унификации законодательных предписаний стран-членов ЕС:

- Механические устройства (98/37/EC).
- Низковольтное оборудование Directive (2006/95/EC).
Применявшиеся стандарты: EN 61800-5-1: 2003, EN 61800-2: 1998 и EN 50529: 1992.
- Электромагнитная совместимость (2004/108/EC).
Применявшиеся стандарты: EN 61800-3: 2004, EN 55011: 1998, EN 55011-A1: 1999 и EN 55011-A2: 2002.

Bjerringbro, 1st April 2008

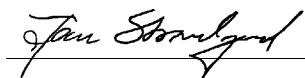

Jan Strandgaard
Technical Director

MP 1

Installation and operating instructions	4	GB
Montage- und Betriebsanleitung	15	D
Notice d'installation et d'entretien	27	F
Istruzioni di installazione e funzionamento	38	I
Monterings- og driftsinstruktion	49	DK
Руководство по монтажу и эксплуатации	60	RU

CONTENTS

	Page
1. Symbols used in this document	4
2. General description	4
2.1 Applications	4
2.2 Technical data	5
3. Safety	5
3.1 Safety precautions	5
4. Transportation and storage	5
4.1 Delivery	5
4.2 Storage	6
5. Installation	6
5.1 Assembly	6
5.2 Borehole diameter	6
5.3 Water level	6
5.4 Checking of liquid in motor	6
5.5 Pipe connection	6
5.6 Lowering the pump	7
5.7 Installation depth	7
6. Converter	7
6.1 Position of converter	7
6.2 Converter buttons	8
7. Electrical connection	9
7.1 Connection of converter	9
7.2 Generator operation	9
7.3 Procedure for starting generator operation	9
7.4 Procedure for stopping generator operation	9
7.5 Connection of pump	9
8. Start-up and operation	10
8.1 Start-up	10
8.2 Operation	10
9. Maintenance and service	10
9.1 Maintenance	10
9.2 Service	11
10. Dismantling and assembly	11
10.1 Description and overview of the MP 1 sampling pump system	11
10.2 Dismantling the pump	12
10.3 Checking of components	12
10.4 Assembling the pump	13
11. Faults, causes and remedy	14
11.1 Restarting after fault	14
11.2 Converter fault indications	14
12. Disposal	14



Warning

Prior to installation, read these installation and operating instructions. Installation and operation must comply with local regulations and accepted codes of good practice.

1. Symbols used in this document



Warning

If these safety instructions are not observed, it may result in personal injury!

Caution

If these safety instructions are not observed, it may result in malfunction or damage to the equipment!

Note

Notes or instructions that make the job easier and ensure safe operation.

2. General description

The MP 1 submersible pump is specially designed for the purging and sampling of contaminated groundwater in boreholes with an internal diameter of at least 50 mm.

The pump is powered via an adjustable converter in the 25 to 400 Hz frequency range. At 400 Hz, the pump provides a flow rate of 1 m³/h at 74 metres head.

Caution

The pump must always be powered via the converter. See fig. 1.



Gr3101 - GRA6096

Fig. 1 MP 1 pump and converter

Pump and motor form a complete unit that can easily be dismantled for cleaning and servicing.

The PTFE motor cable is available in different lengths.

2.1 Applications

The MP 1 pump is designed for the purging and sampling of contaminated water.

The maximum sand content of the water must not exceed 50 g/m³. A larger sand content will reduce the life of the service parts and increase the risk of blocking of the pump.

Water temperature: +1 °C to +30 °C.

All pump components are made from materials not giving off foreign matter to the pumped liquid. This ensures that the sample taken is neither influenced nor altered by the pump.

To avoid cleaning the pump and to eliminate the risk of cross-contamination, permanent installation of the pump is recommended.

It is possible to use the same pump for sampling in several boreholes if the risk of cross-contamination can be eliminated.

Caution

The MP 1 pump is not designed for the pumping of concentrated oils, chemicals or explosive liquids.

When pumping liquids with a density or kinematic viscosity higher than that of water, a motor input power higher than the rated power is required. The maximum performance must therefore be reduced by changing the frequency.

Note

When the MP 1 pump is used, the regulations covering the handling of hazardous material and possible local regulations must be observed.

Caution

The MP 1 pump is not designed for continuous operation like for instance remedial pumping. Continuous operation may reduce the life of the pump.

2.2 Technical data

Marking: The MP 1 sampling pump system is CE-marked.

2.2.1 MP 1 pump

Power input: 1.3 kW.
Voltage: 3 x 220 V, 400 Hz.
Maximum current: 5.5 A.
Motor protection: Built-in thermal switch.
Water temperature: 0 °C to +35 °C.
Discharge port: Rp 3/4.
Continuous operation: Maximum 500 hours.
Net weight: 2.5 kg.

2.2.2 Converter

Supply voltage: 1 x 220-240 V – 15 %/+ 10 %, 50/60 Hz, PE.
Minimum generator size: With voltage control:

- 2.5 kVA.
- 4.0 kVA (recommended size).

Without voltage control:
5.0 kVA.
Rated current: 10 A (at output current).
Output current: 9.6 A (output max., see motor protection below).
Fuse: 10 A.
Power factor: 0.65.
Connecting cable: 3 x 1.5 mm², 3 m with plug.
Output voltage: 3 x 15.4 V, 25 Hz, to 3 x 235 V, 400 Hz.
Motor protection: Built-in overcurrent protection, set to 6.1 A.
Acceleration time: 0 to 400 Hz: Maximum 6 sec.
Deceleration time: 400 to 0 Hz: Maximum 6 sec.
Enclosure class: IP65.
Ambient temperature: –10 °C to +45 °C.
Relative air humidity: Maximum 95 %.
Net weight: 7.7 kg.

2.2.3 Pump performance

For performance curves for the MP 1, see fig. A on page 14.

2.2.4 Dimensions

For dimensional sketches, see figs B, C and D on page 15.

3. Safety

3.1 Safety precautions

Warning

During handling, operation, storage and transportation, the environmental regulations covering the handling of hazardous material must be observed.

When the pump is taken out of operation, care must be taken to ensure that the pump contains no hazardous material that might be injurious to human health or to the environment.

The motor is factory-filled with liquid (approx. 25 ml demineralised water). During operation, this liquid is wholly or partly replaced by the contaminated water. Therefore, there is a potential risk of contamination and poisoning.

The water delivered by the pump may be contaminated and/or toxic. The regulations covering the handling of hazardous material must therefore be observed.



3.1.1 Explosion hazard

The pumping system is **not** approved as explosion-proof. Local authorities and regulations should be consulted if there is any doubt about its suitability for a certain application.

3.1.2 Personal safety equipment

When pumping water containing hazardous material, personal safety equipment must be used.

3.1.3 Warranty

Pumps installed in accordance with these instructions and accepted codes of good practice are covered by the Grundfos warranty.

Any constructional change of the pumping system will invalidate the warranty. Grundfos cannot be held responsible for possible consequential damage.

3.1.4 Electrical connection

When lowering/pulling out the pump, take care not to damage the motor cable. The electrical connections should be carried out in accordance with local regulations.

Caution

Never fit or remove the motor cable plug from the converter unless the electricity supply to the converter has been switched off.

3.1.5 Service

Warning

Only pumps that can be certified as uncontaminated, i.e. pumps containing no hazardous and/or toxic material, may be returned to Grundfos for servicing.



See section 9.2 Service.

4. Transportation and storage

4.1 Delivery

4.1.1 MP 1 pump

After production, the pump has been ultrasonically cleaned and packed into a polyethylene bag. This means that the pump has not been in contact with dirt or detergents after cleaning and it is untouched by persons.

4.1.2 Converter

Caution

The converter should not be exposed to unnecessary shocks and should be handled like sensitive electronic equipment.

4.2 Storage

The pumping system should be stored in a clean and dry area.

4.2.1 MP 1 pump

Storage temperature: $-20\text{ }^{\circ}\text{C}$ to $+50\text{ }^{\circ}\text{C}$.

If the pump has to be stored after use, it must be cleaned thoroughly before storing. See section 9. *Maintenance and service*.

4.2.2 Converter

The converter should be stored in a clean and dry area.

Storage temperature: $-10\text{ }^{\circ}\text{C}$ to $+45\text{ }^{\circ}\text{C}$.

5. Installation

5.1 Assembly

The pump can be installed either horizontally or vertically. The pump discharge port should **never** fall below the horizontal plane. See fig. 2.

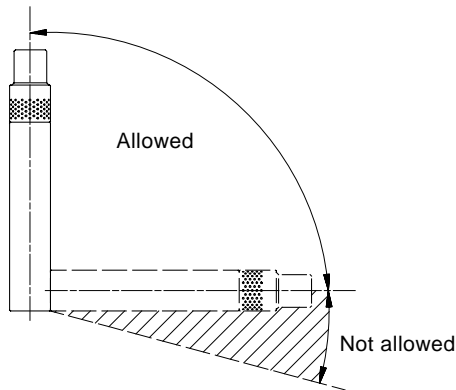

Fig. 2 Positional requirements

During operation, the pump must always be completely submerged in the liquid.

The pump performance is controlled by changing the frequency.

The installation of a valve in the discharge pipe is unnecessary and with regard to the water sample directly inappropriate.

If a valve has been installed anyway, make sure that the pump is only operated against a closed valve for a very short period.

Otherwise the heat generated will cause the pump to stop.

If a non-return valve is installed in the discharge pipe, it must be installed **at least 0.5 metres** above the pump. This is necessary to ensure that the air in the pump is compressed so much that the pump contains water when it is being submerged.

5.2 Borehole diameter

The inside diameter of the sampling borehole must be at least 50 mm. At the first sampling, it is recommended to check the borehole for clearance by means of a calibration punch. If the borehole diameter is larger than 80 mm, the pump can be fitted in a flow sleeve to prevent unintended pump cut-outs. See fig. 3.

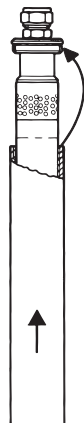

Fig. 3 MP 1 in flow sleeve

5.3 Water level

The dynamic water level (depth to the water level in the borehole during operation) must not exceed 80 metres.

5.4 Checking of liquid in motor

The level of the liquid in the motor should be checked before the pump is installed.

1. Place the pump and motor in a vertical position with the discharge port pointing downwards (i.e. the bottom of the motor is uppermost), and remove the filling screw. See fig. 4.



Fig. 4 Removal of filling screw

2. If the water stands up to the edge of the threaded hole, no filling is required. If not, fill demineralised water into the motor. To enable all air to escape, insert your finger in the pump discharge port and lift the shaft a few times. Recheck the liquid level.

3. Replace and tighten the filling screw.

The pump is now ready for installation.

5.5 Pipe connection

Pump discharge port: Rp 3/4.

A pipe or a hose can be connected to the pump.

Whenever a hose is fitted, a compression coupling must be used. See fig. 5.

Tighten the union nut using fingers only and then give it 1 1/4 turns with a tool.

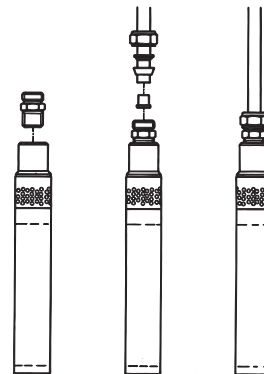

Fig. 5 Use of compression coupling

If PTFE pipes or hoses or unarmoured hoses are used, a stainless-steel straining wire is required for lowering and lifting the pump.
Secure the straining wire to the pump with a wire holder.
See fig. 6.

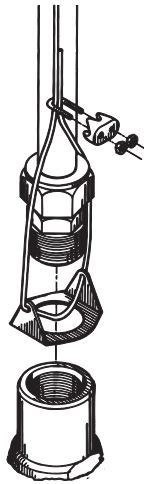

Fig. 6 Fitting the straining wire

TM00 0875 4092

Spiral flex or cable clips are used for fitting the cable and the straining wire (if fitted) to the riser pipe/hose. The spiral flex or cable clips should be fitted every 1 to 3 metres. See fig. 7.



Fig. 7 Spiral flex

TM00 1147 4092

5.6 Lowering the pump

Lower the pump into the borehole, taking care not to damage the motor cable.

Caution *Do not lower or lift the pump by the motor cable.*

5.7 Installation depth

During operation, the pump and motor must be completely submerged to ensure the necessary lubrication of the shaft seal and cooling of the motor.

If the pump pumps more water than the borehole can yield, there is a risk that the water level falls below the level of the pump inlet and that air is therefore sucked into the pump.

Caution *Long time of operation with water containing air may damage the pump and cause insufficient cooling of the motor.*

If a non-return valve is installed in the discharge pipe, it must be installed **at least 0.5 metres** above the pump. This is necessary to ensure that the air in the pump is compressed so much that the pump contains water when it is being submerged.

6. Converter

6.1 Position of converter

Caution *Place the converter with cabinet in such a way that water cannot enter into the cabinet.
Do not close the cabinet during operation.*

The converter must be installed vertically to ensure free air circulation around the unit. See fig. 8.

Make sure that the cabinet/converter cannot tip during operation.



Fig. 8 Vertical installation of the converter

GrA6096

6.2 Converter buttons

The converter buttons are used to change control parameters, to operate the MP 1 pump and to change over between the displays in order to monitor the status of the pump.

Some of the buttons incorporate indicator lights.

Indicator light	Description
[FWD] button (green)	The indicator light is on when the motor rotates in the forward direction.
[REV] button (green)	The indicator light is on when the motor rotates in the reverse direction.
[STOP] button (red)	The indicator light is on when [STOP] has been pressed.

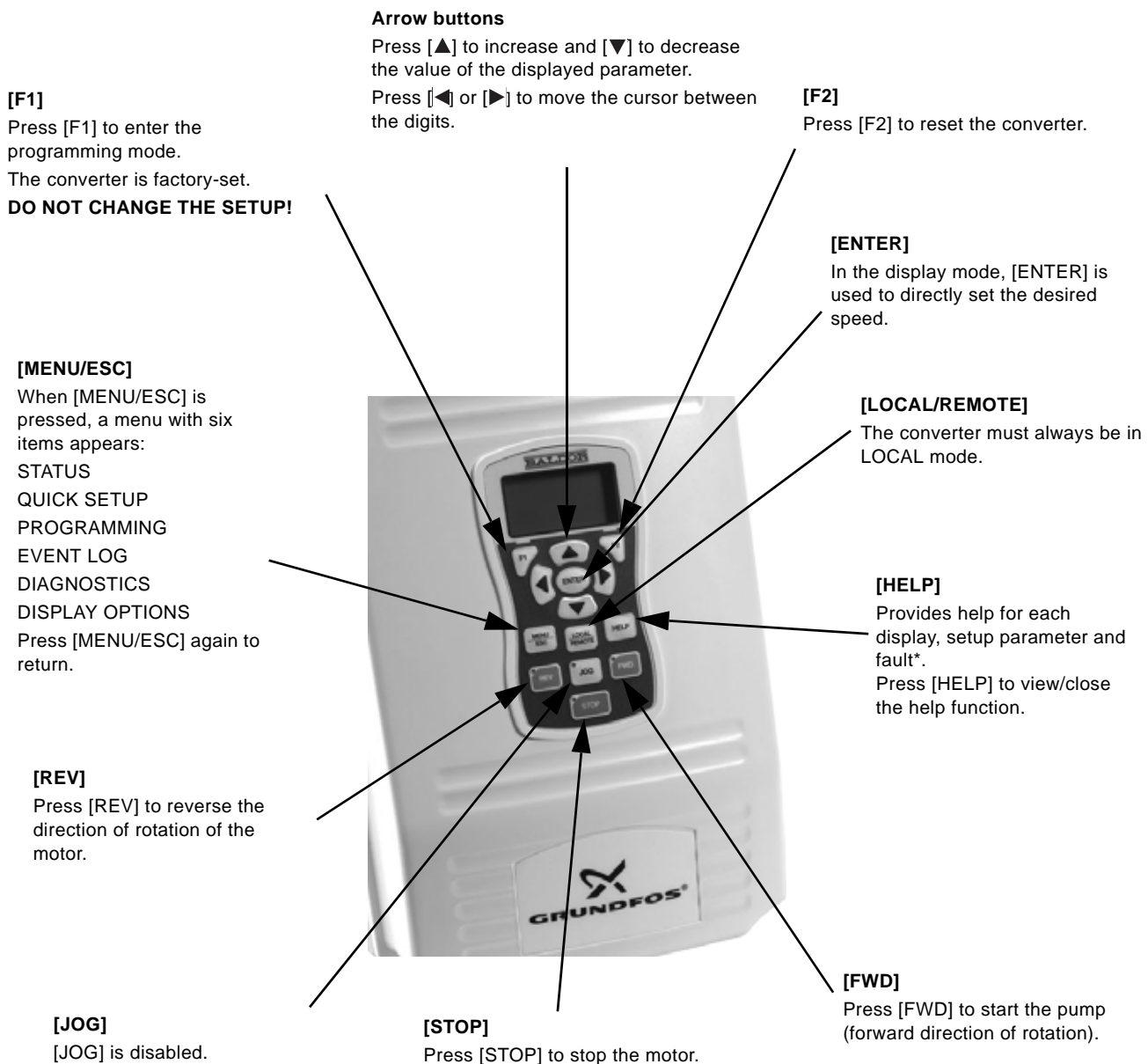

Fig. 9 Converter buttons

* For possible display texts, see page 16.

7. Electrical connection



Warning

Before starting work on the pump, make sure that the electricity supply has been switched off and that it cannot be accidentally switched on.

7.1 Connection of converter

The electrical connection of the converter should be carried out in accordance with local regulations and standards.

Connect the converter to the mains supply (1 x 220-240 V – 15 %/+ 10 %, 50/60 Hz, PE) as follows:

1. Loosen the front cover by removing the four screws in the corners.
2. Lift up the cover.
3. Remove the cap from one of the cable entries, and fit a gland for the mains cable.
4. Connect the mains cable (min. 3 x 1.5 mm²) according to the table below.

Connector inside the converter									
L1	L2	N	GND	R1/B+	R2	B-	T1	T2	T3
Phase	Neutral	Not used	PE						



Warning

The pump must be earthed.

If the pump is connected to an electric installation where an earth leakage circuit breaker (ELCB) is used as additional protection, this circuit breaker **must** trip out when earth fault currents with DC content (pulsating DC) occur.

The earth leakage circuit breaker **must** be marked with the symbol shown:

By means of the converter, the frequency can be continuously adjusted from approx. 25 to approx. 400 Hz.

The portable MP 1 sampling unit is primarily designed for generator operation. If the unit is connected to the mains supply, local regulations dealing with radio interference suppression must be observed. It is recommended to install a radio noise filter between the MP 1 converter and the supply mains.

Note

Before the MP 1 converter is connected, it **must** be checked that the supply voltage lies within the following range:
1 x 220-240 V – 15 %/+ 10 %, 50/60 Hz, PE.

7.2 Generator operation

When a generator is used, it is particularly important to check that the voltage lies within the specified range.

7.3 Procedure for starting generator operation

1. Lower the MP 1 pump into the borehole. Connect the motor leads to the MP 1 converter. See section 7.5 *Connection of pump*.
2. Start the generator. Connect the MP 1 converter to the generator when the generator is operating steadily. The generator output voltage must lie within the specified range, i.e. 1 x 220-240 V – 15 %/+ 10 %, 50/60 Hz, PE, to ensure proper operation and prevent damage to the system. If the voltage is too high or too low, adjustments to the generator must be made to allow the system to run.

3. The frequency converter will initialise and is ready to drive the motor. After the initialisation, the following will be displayed:

DIAG.	STOP ¹	LOCAL
	MP 1 ²	
MOTOR VOLTS		0.0 V ³
MOTOR CURR		0.0 A ⁴
MOTOR FREQ		0.00 Hz ⁵
PROG	0.00r	MAIN

Fig. 10 Display text

Explanation to the display

Pos.	Display	Description
1	STOP or FWD	Status
2	MP 1 or SPE	Pump type
3	Output voltage	Motor voltage
4	X.X A	Motor current (output current)
5	X.XX Hz	Motor frequency (output frequency in Hz)

4. Press [FWD] to start the pump.
5. Press [▲] to increase the speed, or press [▼] to decrease the speed. To increase or decrease the speed in larger increments, keep the button pressed.
6. Press [STOP] to stop the pump.
See section 7.4 *Procedure for stopping generator operation*.
7. Press [ENTER] to allow the user to quickly set the speed to any given value. Press [▲] or [▼] to change the speed and [◀] or [▶] to move the cursor between digits. The default speed setting is 25 Hz. Press [FWD] once to run the motor at the set speed.

7.4 Procedure for stopping generator operation

1. Press [STOP] on the MP 1 converter.
2. Wait until MOTOR FREQ shows 0.00 Hz in the display.
3. Disconnect the MP 1 converter.
4. Stop the generator.
5. Disconnect the MP 1 pump from the MP 1 converter.



Fig. 11 [STOP] button

7.5 Connection of pump

Connect the motor cable from the pump at the bottom of the converter.



Warning

Never fit or remove the motor cable plug from the converter unless the electricity supply to the converter has been switched off.

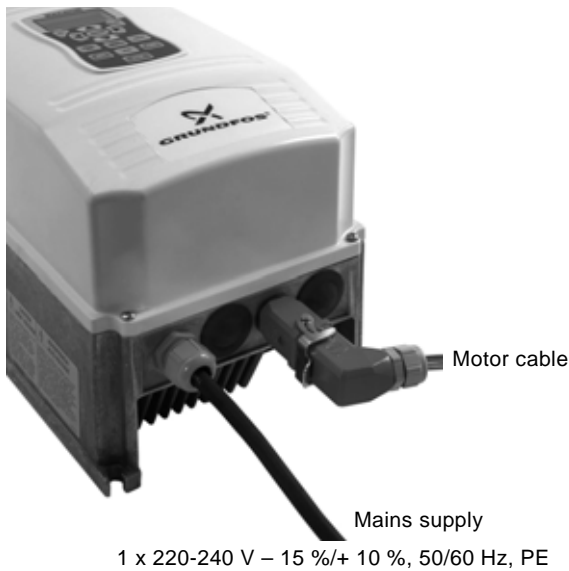

1 x 220-240 V – 15 %/+ 10 %, 50/60 Hz, PE

GrA6101

Fig. 12 Converter connections

8. Start-up and operation

8.1 Start-up

Switch on the electricity supply when the pump has been installed and connected to the converter.

The display shows:

DIAG.	STOP	LOCAL
	MP 1	
MOTOR VOLTS		0.0 V
MOTOR CURR		0.0 A
MOTOR FREQ		0.00 Hz
PROG	0.00r	MAIN

- Press [FWD] to start the pump. See fig. 13, pos. A.

The actual motor speed [Hz] appears in the display: Parameter MOTOR FREQ.



GrA6103

Fig. 13 [FWD] button

8.1.1 Speed control

The actual speed can be set in two ways.

1. Press [FWD] to start the pump.

Method 1:

2. Press [▲] to increase the speed, or press [▼] to decrease the speed. To increase or decrease the speed in larger increments, keep the button pressed.

Method 2:

3. Press [ENTER] to allow the user to quickly set the speed to any given value. Press [▲] or [▼] to change the speed and [◀] or [▶] to move the cursor between digits. The default speed setting is 25 Hz. Press [FWD] once to run the motor at the set speed.
4. Press [STOP] to stop the pump.

Caution The MP 1 pump is not designed for continuous operation like for instance remedial pumping. Continuous operation may reduce the life of the pump.

8.2 Operation

8.2.1 Setting of pump performance

When the pump speed has been changed, wait a while to let the speed settle at the set level. Then new adjustments can be made.

8.2.2 Minimum flow

To ensure the necessary cooling of the motor, the pump should never be set so low that it gives no water.

If the flow rate suddenly falls, the reason might be that the pump is pumping more water than the borehole can yield. The pump performance must immediately be reduced or the pump must be stopped to avoid damage to the pump.

8.2.3 After use

After use, switch off the electricity supply to the converter **before** the motor cable is disconnected from the converter.

9. Maintenance and service

9.1 Maintenance

If the pump is used alternately in several boreholes, it must be decontaminated before every sampling event or before possible storing.

Clean the pump, cable, straining wire, etc. on the outside. Then dismantle the pump. Thoroughly clean the pump components before reassembling the pump. See section 10. *Dismantling and assembly.*

As the demineralised water (approx. 25 ml) in the motor may have been wholly or partly replaced by the contaminated water, it is necessary to refill the motor with demineralised water. See section 5.4 *Checking of liquid in motor.*

For the replacement of wear parts including impellers, see fig. 14, a service kit (product number 125061) is available. The kit includes two complete pump stages. Replace the wear parts including impellers as shown in section 10. *Dismantling and assembly.*

In addition, a service kit (product number 1A5050) is available. This kit includes wear parts for two pumps, i.e. 4 washers, pos. 285, and 4 seals, pos. 207. See fig. 14.

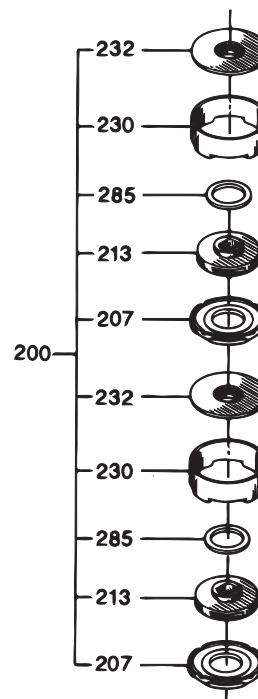

Fig. 14 Wear parts

TM00 0888 4092



Warning

The rinsing water from the decontamination and the motor liquid must be collected and disposed of in accordance with local regulations.

9.2 Service

The MP 1 pump is specially designed for the purging and sampling of contaminated and/or toxic groundwater. As a precaution, Grundfos cannot undertake to service the MP 1 pump.

Only pumps that can be certified as uncontaminated, i.e. pumps containing no hazardous and/or toxic material, may be returned to Grundfos for servicing.

To prevent injury to the health of persons involved and to the environment, a document certifying that the pump is clean is required.

Grundfos must receive this certificate before the product. Otherwise Grundfos will refuse to accept the product for servicing. Possible costs of returning the product are paid by the customer.

If the converter is defective, please contact your nearest Grundfos distributor.

10. Dismantling and assembly

10.1 Description and overview of the MP 1 sampling pump system

Components

Pos.	Designation
1	Motor with suction interconnector
74	Filling screw
74a	O-ring for filling screw
200	Service kit: wear parts including impellers
201a	Chamber/pump housing
207	Seal
213	Impeller
215	Strainer
215a	Screw
230	Intermediate ring
232	Guide vanes
285	Washer
A	Pump with motor
B	Converter

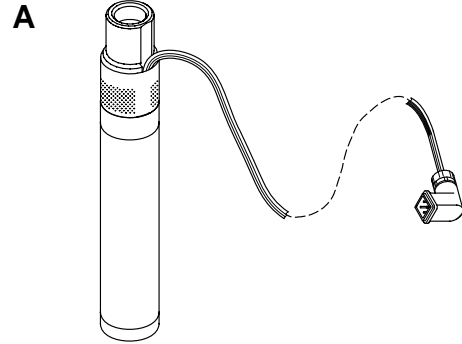

Fig. 15 MP 1 pump and converter

TM00 0895 4402 - GRA6096

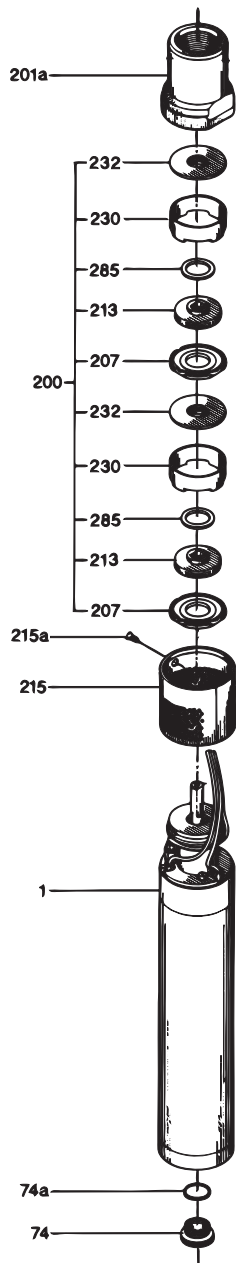

Fig. 16 Pump components

When servicing the MP 1 sampling pump, note that the pumped liquid is often unknown. Therefore, the necessary precautionary measures must be taken in accordance with local regulations.



Warning

All work on the electric parts of the MP 1 sampling pump system must be carried out by a qualified service engineer.

If the motor, motor cable, converter or converter cable is defective, please contact your nearest Grundfos distributor.

TM00 0890 4092

10.2 Dismantling the pump

Procedure (see fig. 16):

1. Place the pump in upright position with the discharge port uppermost.
2. If the pump is fitted with hose and fittings, remove these.
3. Slacken and remove the screw (pos. 215a).
4. Remove the strainer (pos. 215).
5. Screw (right-hand thread) the pump housing (pos. 201a) off the suction interconnector on the motor (pos. 1).
6. Pull the pump housing and the wear parts including impellers (pos. 200) off the motor shaft. Push the wear parts including impellers out of the pump housing from the discharge side.
7. Dismantle the wear parts including impellers (pos. 200).
8. Clean the holes in the suction interconnector.
9. Clean and check all parts. See section 10.3 *Checking of components*.

For assembly of the pump, see section 10.4 *Assembling the pump*.

10.3 Checking of components

When the pump has been dismantled, all parts must be cleaned and checked for fractures, corrosion and wear.

Apart from the visual inspection, it is necessary to measure the following parts:

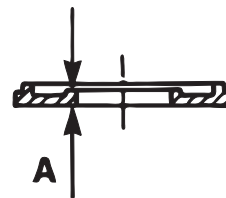

Fig. 17 Seal (pos. 207) – A = Min. 1.5 mm

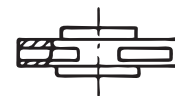

Fig. 18 Impeller (pos. 213) – no measurable wear

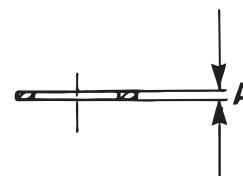
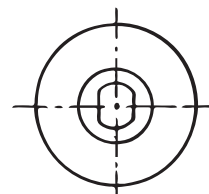

Fig. 19 Washer (pos. 285) – A = Min. 1.0 mm

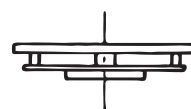

Fig. 20 Guide vanes (pos. 232) – no measurable wear

TM00 1169 4692

TM00 1170 4692

TM00 1171 4692

TM00 1172 4692

10.4 Assembling the pump

Procedure (see fig. 21):

1. Fit the seal (pos. 207) to the intermediate ring (pos. 230).
The dogs of the intermediate ring must engage with the seal.
2. Position the intermediate ring and the seal on the motor with suction interconnector (pos. 1).
3. Fit the impeller (pos. 213) to the shaft and push it against the seal (pos. 207). The skirt of the impeller must fit into the hole of the seal.
4. Fit the washer (pos. 285) to the impeller.
5. Fit the guide vanes (pos. 232) to the intermediate ring.

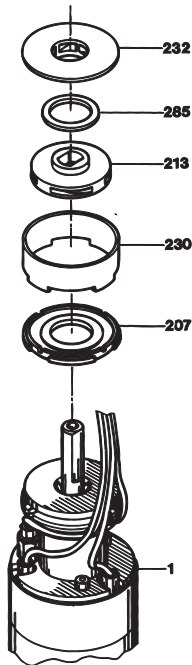

TM00 0891 4092

Fig. 21 Assembling the pump

6. Repeat the procedure with seal, intermediate ring, impeller, washer and guide vanes.
 7. Push the pump housing (pos. 201a) over the wear parts including impellers (pos. 200) and screw it on the suction interconnector on the motor (pos. 1). See fig. 16.
 8. Position the cable along the pump housing (in the recess).
 9. Push the strainer (pos. 215) over the pump housing, and press it against the motor. Turn the strainer to the right so that the hole of the strainer and that of the pump housing are in the same position.
 10. Fit and tighten the screw (pos. 215a).
- The pump is now assembled and it can be tested.

11. Faults, causes and remedy

11.1 Restarting after fault

If the converter has cut out because of one of the faults shown in section 11.2, the converter must be reset before the pump can be restarted. Press [F2]. Locate the fault according to the table below, and correct the fault.

Press [F2] on the converter. Then the display indication will change into the initial display text. See fig. 10. The pump is now ready for restarting. See section 8.1 *Start-up*.

11.2 Converter fault indications

Fault (display text)	Cause	Remedy
1. Overcurrent	The motor current exceeded the peak limit.	Reduce the frequency. Check the motor for overload.
2. Desaturation	The motor current exceeds the desaturation limit.	Check the motor for blockage and short-circuit of the motor cable.
3. Ground fault	A ground fault has been detected (leakage to ground).	Check the motor cable and the MP 1 with a megohmmeter. The insulation resistance must be higher than 0.5 MΩ at 1000 V. Note: Before measuring the resistance, disconnect the motor cable plug from the converter.
4. Overload 1 minute	The output current exceeded the limit for more than 1 minute.	Reduce the frequency.
5. Overload 3 seconds	The output current exceeded the limit for more than 3 seconds.	Reduce the frequency.
6. Motor overload	The motor current exceeded the preset limits: <ul style="list-style-type: none">• 125 % for 590 seconds• 150 % for 150 seconds• 200 % for 50 seconds.	Reduce the frequency. Check the motor for overload.
7. DC bus high	The AC mains voltage is higher than 300 V.	Check that the mains voltage lies within the voltage range, 1 x 220-240 V – 15 %/+ 10 %.
8. DC bus low	The AC mains voltage is lower than 163 V.	Check that the mains voltage lies within the voltage range, 1 x 220-240 V – 15 %/+ 10 %.
9. Drive over temp.	Converter temperature above +85 °C.	Check that the ambient temperature is lower than +45 °C.
10. Drive low temp.	Converter temperature below –10 °C.	The converter temperature must be above –10 °C before use.

If the motor, motor cable, converter or converter cable is defective, please contact your nearest Grundfos distributor.
For other possible display texts, see page 16.

12. Disposal

This product or parts of it must be disposed of in an environmentally sound way:

1. Use the public or private waste collection service.
2. If this is not possible, contact the nearest Grundfos company or service workshop.

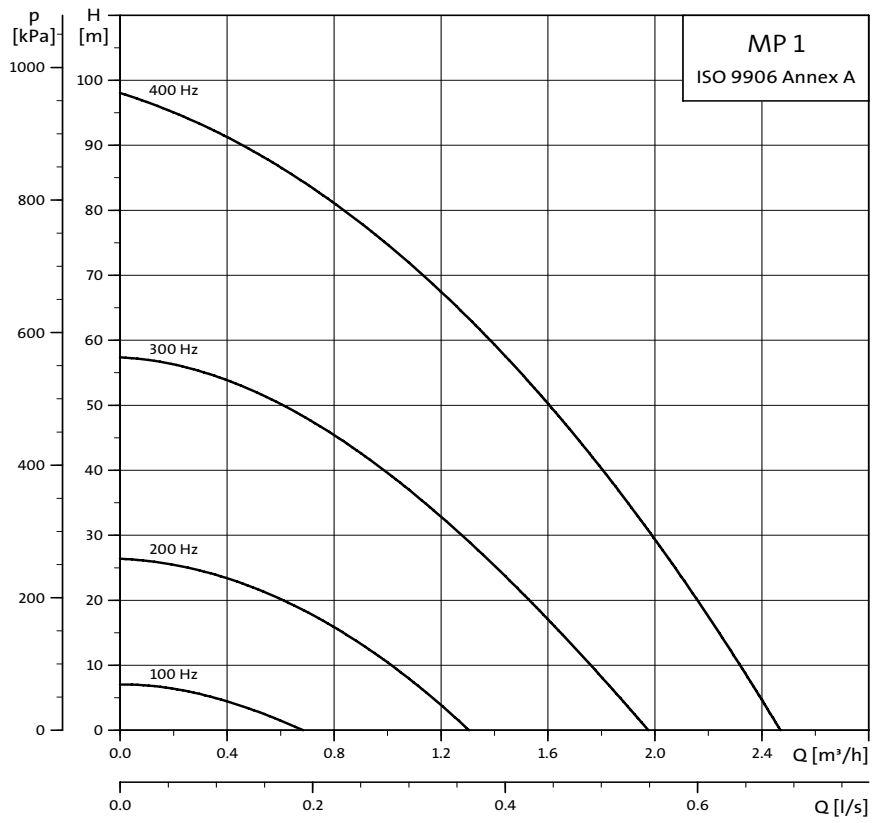

Fig. A Performance curves for MP 1

TM00 7778 5002

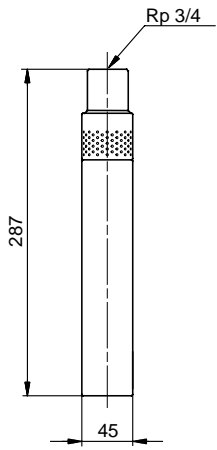

Fig. B MP 1 pump

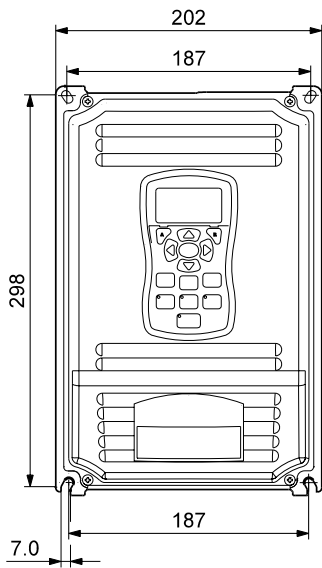
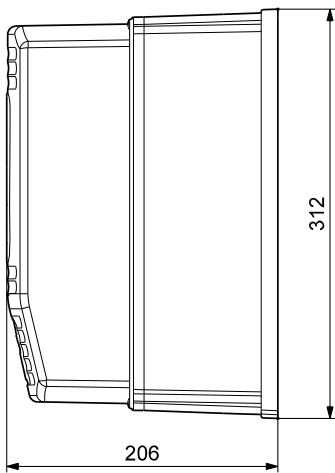

Fig. C MP 1 converter



TM00 0531 0894

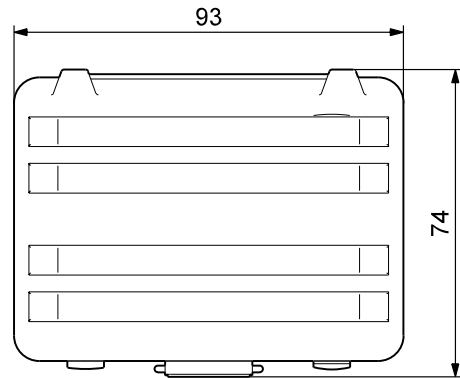
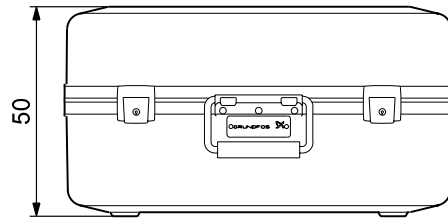

Fig. D Cabinet for MP 1 converter

TM04 1757 1008

TM04 1456 1008

Other possible display texts

Display text	Description	Remedy
1. Unknown system fault	Display texts 1 to 66 will appear	Contact Grundfos
2. Configuration	<ul style="list-style-type: none"> in case of an error inside the converter or 	
3. SPI timeout	<ul style="list-style-type: none"> just as information for the user. 	
4. Param checksum		
5. New base ID		
6. Logic supply		
7. Power base fault		
8. Low initial BUS		
9. Current sense		
10. User ref		
11. User 24V		
12. Current reference		
13. Following error		
14. External trip		
15. Torque proving		
16. Regen R or PWR		
17. EEPROM fault		
18. Internal config		
19. Dyn Brake desat		
20. Line loss		
21. Phase loss		
22. U upper fault		
23. U Lower fault		
24. V upper fault		
25. V lower fault		
26. W upper fault		
27. W lower fault		
28. Ph 1 pulse		
29. Ph 2 pulse		
30. Ph 3 pulse		
31. Network timeout		
32. Memory		
33. Aux filter setup		
34. Power base FPGA		
35. Sel FB source		
36. Download		
37. parameter		
38. Invalid FB sel		
39. ADC calib fault		
40. Encoder loss		
41. Over speed		
42. DC bus short		
43. Motor overtemp		
44. Fan loss		
45. DC PK overvolt		
46. Line sag		
47. Brake desat		
48. Pre charge fault		
49. Drive disabled		
50. Drive enabled		
51. PB power supply		
52. AC input high		
53. Initial pos		
54. Invalid res sel		
55. Resolver loss		
56. PF setup		
57. Option not found		
58. Pos cnt overflow		
59. Opt1 protocol or Opt 2 protocol		

Display text	Description	Remedy
60. Excess faults/hr	Display texts 1 to 66 will appear	Contact Grundfos
61. Motor overload	<ul style="list-style-type: none">• in case of an error inside the converter or	
62. PLC mode trip	<ul style="list-style-type: none">• just as information for the user.	
63. Macro read		
64. Macro rec length		
65. Macro CMD inwal		
66. Macro CMD Failed		

Argentina

Bombas GRUNDFOS de Argentina S.A.
Ruta Panamericana km. 37.500 Lote
34A
1619 - Garin
Pcia. de Buenos Aires
Phone: +54-3327 414 444
Telefax: +54-3327 411 111

Australia

GRUNDFOS Pumps Pty. Ltd.
P.O. Box 2040
Regency Park
South Australia 5942
Phone: +61-8-8461-4611
Telefax: +61-8-8340 0155

Austria

GRUNDFOS Pumpen Vertrieb
Ges.m.b.H.
Grundfosstraße 2
A-5082 Grödig/Salzburg
Tel.: +43-6246-883-0
Telefax: +43-6246-883-30

Belgium

N.V. GRUNDFOS Bellux S.A.
Boomsesteenweg 81-83
B-2630 Aartselaar
Tél.: +32-3-870 7300
Télécopie: +32-3-870 7301

Belorussia

Представительство ГРУНДФОС в
Минске
220090 Минск ул.Олешева 14
Телефон: (8632) 62-40-49
Факс: (8632) 62-40-49

Bosnia/Herzegovina

GRUNDFOS Sarajevo
Paromlinska br. 16,
BiH-71000 Sarajevo
Phone: +387 33 713290
Telefax: +387 33 231795

Brazil

Mark GRUNDFOS Ltda.
Av. Humberto de Alencar Castelo
Branco, 630
CEP 09850 - 300
São Bernardo do Campo - SP
Phone: +55-11 4393 5533
Telefax: +55-11 4343 5015

Bulgaria

GRUNDFOS Pumpen Vertrieb
Representative Office - Bulgaria
Bulgaria, 1421 Sofia
Lozenetz District
105-107 Arsenalski Blvd.
Phone: +359 2963 3820, 2963 5653
Telefax: +359 2963 1305

Canada

GRUNDFOS Canada Inc.
2941 Brighton Road
Oakville, Ontario
L6H 6C9
Phone: +1-905 829 9533
Telefax: +1-905 829 9512

China

GRUNDFOS Pumps (Shanghai) Co. Ltd.
51 Floor, Raffles City
No. 268 Xi Zang Road. (M)
Shanghai 200001
PRC
Phone: +86-021-612 252 22
Telefax: +86-021-612 253 33

Croatia

GRUNDFOS predstavništvo Zagreb
Cebini 37, Buzin
HR-10010 Zagreb
Phone: +385 1 6595 400
Telefax: +385 1 6595 499

Czech Republic

GRUNDFOS s.r.o.
Čajkovského 21
779 00 Olomouc
Phone: +420-585-716 111
Telefax: +420-585-716 299

Denmark

GRUNDFOS DK A/S
Martin Bachs Vej 3
DK-8850 Bjerringbro
Tlf.: +45-87 50 50 50
Telefax: +45-87 50 51 51
E-mail: info_GDK@grundfos.com
www.grundfos.com/DK

Estonia

GRUNDFOS Pumps Eesti OÜ
Peterburi tee 92G
11415 Tallinn
Tel: + 372 606 1690
Fax: + 372 606 1691

Finland

OY GRUNDFOS Pumput AB
Mestarintie 11
FIN-01730 Vantaa
Phone: +358-3066 5650
Telefax: +358-3066 56550

France

Pompes GRUNDFOS Distribution S.A.
Parc d'Activités de Chesnes
57, rue de Malacombe
F-38290 St. Quentin Fallavier (Lyon)
Tél.: +33-4 74 82 15 15
Télécopie: +33-4 74 94 10 51

Germany

GRUNDFOS GMBH
Schlüterstr. 33
40699 Erkrath
Tel.: +49-(0) 211 929 69-0
Telefax: +49-(0) 211 929 69-3799
e-mail: infoservice@grundfos.de
Service in Deutschland:
e-mail: kundendienst@grundfos.de

Greece

GRUNDFOS Hellas A.E.B.E.
20th km. Athinon-Markopoulou Av.
P.O. Box 71
GR-19002 Peania
Phone: +0030-210-66 83 400
Telefax: +0030-210-66 46 273

Hong Kong

GRUNDFOS Pumps (Hong Kong) Ltd.
Unit 1, Ground floor
Siu Wai Industrial Centre
29-33 Wing Hong Street &
68 King Lam Street, Cheung Sha Wan
Kowloon
Phone: +852-27861706 / 27861741
Telefax: +852-27858664

Hungary

GRUNDFOS Hungária Kft.
Park u. 8
H-2045 Törökbálint,
Phone: +36-23 511 110
Telefax: +36-23 511 111

India

GRUNDFOS Pumps India Private Limited
118 Old Mahabalipuram Road
Thoraipakkam
Chennai 600 096
Phone: +91-44 2496 6800

Indonesia

PT GRUNDFOS Pompa
Jl. Rawa Sumur III, Blok III / CC-1
Kawasan Industri, Pulogadung
Jakarta 13930
Phone: +62-21-460 6909
Telefax: +62-21-460 6910 / 460 6901

Ireland

GRUNDFOS (Ireland) Ltd.
Unit A, Merrywell Business Park
Ballymount Road Lower
Dublin 12
Phone: +353-1-4089 800
Telefax: +353-1-4089 830

Italy

GRUNDFOS Pompe Italia S.r.l.
Via Gran Sasso 4
I-20060 Truccazzano (Milano)
Tel.: +39-02-95838112
Telefax: +39-02-95309290 / 95838461

Japan

GRUNDFOS Pumps K.K.
Gotanda Metalion Bldg., 5F,
5-21-15, Higashi-gotanda
Shiagawa-ku, Tokyo
141-0022 Japan
Phone: +81 35 448 1391
Telefax: +81 35 448 9619

Korea

GRUNDFOS Pumps Korea Ltd.
6th Floor, Aju Building 679-5
Yeoksam-dong, Kangnam-ku, 135-916
Seoul, Korea
Phone: +82-2-5317 600
Telefax: +82-2-5633 725

Latvia

SIA GRUNDFOS Pumps Latvia
Deglava biznesa centrs
Augusta Deglava ielā 60, LV-1035, Rīga,
Tālr.: + 371 714 9640, 7 149 641
Fakss: + 371 914 9646

Lithuania

GRUNDFOS Pumps UAB
Smolensko g. 6
LT-03201 Vilnius
Tel: + 370 52 395 430
Fax: + 370 52 395 431

Malaysia

GRUNDFOS Pumps Sdn. Bhd.
7 Jalan Peguam U1/25
Glenmarie Industrial Park
40150 Shah Alam
Selangor
Phone: +60-3-5569 2922
Telefax: +60-3-5569 2866

México

Bombas GRUNDFOS de México S.A. de
C.V.
Boulevard TLC No. 15
Parque Industrial Stiva Aeropuerto
Apodaca, N.L. 66600
Phone: +52-81-8144 4000
Telefax: +52-81-8144 4010

Netherlands

GRUNDFOS Netherlands
Veluwezoom 35
1326 AE Almere
Postbus 22015
1302 CA ALMERE
Tel.: +31-88-478 6336
Telefax: +31-88-478 6332
e-mail: info_gnl@grundfos.com

New Zealand

GRUNDFOS Pumps NZ Ltd.
17 Beatrice Tinsley Crescent
North Harbour Industrial Estate
Albany, Auckland
Phone: +64-9-415 3240
Telefax: +64-9-415 3250

Norway

GRUNDFOS Pumper A/S
Strømsveien 344
Postboks 235, Leirdal
N-1011 Oslo
Tlf.: +47-22 90 47 00
Telefax: +47-22 32 21 50

Poland

GRUNDFOS Pompy Sp. z o.o.
ul. Klonowa 23
Baranowo k. Poznania
PL-62-081 Przeźmierowo
Tel: (+48-61) 650 13 00
Fax: (+48-61) 650 13 50

Portugal

Bombas GRUNDFOS Portugal, S.A.
Rua Calvet de Magalhães, 241
Apartado 1079
P-2770-153 Paço de Arcos
Tel.: +351-21-440 76 00
Telefax: +351-21-440 76 90

România

GRUNDFOS Pompe România SRL
Bd. Biruintei, nr 103
Pantelimon county Ilfov
Phone: +40 21 200 4100
Telefax: +40 21 200 4101
E-mail: romania@grundfos.ro

Russia

ООО Грундфос
Россия, 109544 Москва, ул. Школьная
39
Тел. (+7) 495 737 30 00, 564 88 00
Факс (+7) 495 737 75 36, 564 88 11
E-mail
grundfos.moscow@grundfos.com

Serbia

GRUNDFOS Predstavništvo Beograd
Dr. Milutina Ivkovića 2a/29
YU-11000 Beograd
Phone: +381 11 26 47 877 / 11 26 47
496
Telefax: +381 11 26 48 340

Singapore

GRUNDFOS (Singapore) Pte. Ltd.
24 Tuas West Road
Jurong Town
Singapore 638381
Phone: +65-6865 1222
Telefax: +65-6861 8402

Slovenia

GRUNDFOS PUMPEM VERTRIEB
Ges.m.b.H.,
Podružnica Ljubljana
Blatnica 1, SI-1236 Trzin
Phone: +386 01 568 0610
Telefax: +386 01 568 0619
E-mail: slovenia@grundfos.si

Spain

Bombas GRUNDFOS España S.A.
Camino de la Fuentecilla, s/n
E-28110 Algete (Madrid)
Tel.: +34-91-848 8800
Telefax: +34-91-628 0465

Sweden

GRUNDFOS AB
Box 333 (Lunnagårdsgatan 6)
431 24 Mölndal
Tel.: +46(0)771-32 23 00
Telefax: +46(0)31-331 94 60

Switzerland

GRUNDFOS Pumpen AG
Bruggacherstrasse 10
CH-8117 Fällanden/ZH
Tel.: +41-1-806 8111
Telefax: +41-1-806 8115

Taiwan

GRUNDFOS Pumps (Taiwan) Ltd.
7 Floor, 219 Min-Chuan Road
Taichung, Taiwan, R.O.C.
Phone: +886-4-2305 0868
Telefax: +886-4-2305 0878

Thailand

GRUNDFOS (Thailand) Ltd.
92 Chaloen Phrakiat Rama 9 Road,
Dokmai, Pravej, Bangkok 10250
Phone: +66-2-725 8999
Telefax: +66-2-725 8998

Turkey

GRUNDFOS POMPA San. ve Tic. Ltd.
Sti.
Gebze Organize Sanayi Bölgesi
Ihsan dede Caddesi,
2. yol 200. Sokak No. 204
41490 Gebze/ Kocaeli
Phone: +90 - 262-679 7979
Telefax: +90 - 262-679 7905
E-mail: satis@grundfos.com

Ukraine

ТОВ ГРУНДФОС УКРАЇНА
01010 Київ, Вул. Московська 86,
Тел.: (+38 044) 390 40 50
Факс.: (+38 044) 390 40 59
E-mail: ukraine@grundfos.com

United Arab Emirates

GRUNDFOS Gulf Distribution
P.O. Box 16768
Jebel Ali Free Zone
Dubai
Phone: +971-4- 8815 166
Telefax: +971-4-8815 136

United Kingdom

GRUNDFOS Pumps Ltd.
Grovebury Road
Leighton Buzzard/Beds. LU7 8TL
Phone: +44-1525-850000
Telefax: +44-1525-850011

U.S.A.

GRUNDFOS Pumps Corporation
17100 West 118th Terrace
Olathe, Kansas 66061
Phone: +1-913-227-3400
Telefax: +1-913-227-3500

Uzbekistan

Представительство ГРУНДФОС в
Ташкенте
700000 Ташкент ул.Усмана Носира 1-й
тулик 5
Телефон: (3712) 55-68-15
Факс: (3712) 53-36-35

V7048353 1108	301
Repl. V7048353 0508	