

# Altivar 71

Programming manual

Retain for future use

Variable speed drives  
for asynchronous motors

Software V1.2





# Contents

---

|   |     |
|---|-----|
| Before you begin                              | 4   |
| Documentation structure                       | 5   |
| Software enhancements                         | 6   |
| Steps for setting up the braking unit         | 8   |
| Factory configuration                         | 9   |
| Application functions                         | 10  |
| Setup - Preliminary recommendations           | 14  |
| Graphic display terminal                      | 16  |
| Description of terminal                       | 16  |
| Description of the graphic screen             | 17  |
| First power-up - [5. LANGUAGE] menu           | 20  |
| Subsequent power ups                          | 21  |
| Programming: Example of accessing a parameter | 22  |
| Quick navigation                              | 23  |
| Integrated display terminal                   | 26  |
| Functions of the display and the keys         | 26  |
| Accessing menus                               | 27  |
| Accessing menu parameters                     | 28  |
| [2. ACCESS LEVEL] (LAC-)                      | 29  |
| Structure of parameter tables                 | 32  |
| Interdependence of parameter values           | 33  |
| Finding a parameter in this document          | 34  |
| [1.1 SIMPLY START] (SIM-)                     | 35  |
| [1.2 MONITORING] (SUP-)                       | 43  |
| [1.3 SETTINGS] (SEt-)                         | 52  |
| [1.4 MOTOR CONTROL] (drC-)                    | 66  |
| [1.5 INPUTS / OUTPUTS CFG] (I-O-)             | 85  |
| [1.6 COMMAND] (CtL-)                          | 113 |
| [1.7 APPLICATION FUNCT.] (FUh-)               | 126 |
| [1.8 FAULT MANAGEMENT] (FLt-)                 | 210 |
| [1.9 COMMUNICATION] (COM-)                    | 234 |
| [1.10 DIAGNOSTICS]                            | 238 |
| [1.11 IDENTIFICATION]                         | 240 |
| [1.12 FACTORY SETTINGS] (FCS-)                | 241 |
| [1.13 USER MENU] (USr-)                       | 244 |
| [1.14 PROGRAMMABLE CARD] (PLC-)               | 245 |
| [3. OPEN/SAVE AS]                             | 246 |
| [4. PASSWORD] (COd-)                          | 248 |
| [6 MONITORING CONFIG.]                        | 250 |
| [7 DISPLAY CONFIG.]                           | 254 |
| [MULTIPOINT SCREEN]                           | 259 |
| Maintenance                                   | 260 |
| Faults - Causes - Remedies                    | 261 |
| User settings tables                          | 267 |
| Index of functions                            | 269 |
| Index of parameter codes                      | 270 |

# Before you begin

---

Read and understand these instructions before performing any procedure on this drive.

## DANGER

### HAZARDOUS VOLTAGE

- Read and understand the Installation Manual before installing or operating the ATV71 drive. Installation, adjustment, repair, and maintenance must be performed by qualified personnel.
- The user is responsible for compliance with all international and national electrical standards in force concerning protective grounding of all equipment.
- Many parts of this variable speed drive, including the printed circuit boards, operate at the line voltage. **DO NOT TOUCH.**  
Use only electrically insulated tools.
- **DO NOT** touch unshielded components or terminal strip screw connections with voltage present.
- **DO NOT** short across terminals PA/+ and PC/- or across the DC bus capacitors.
- Install and close all the covers before applying power or starting and stopping the drive.
- Before servicing the variable speed drive
  - Disconnect all power.
  - Place a “DO NOT TURN ON” label on the variable speed drive disconnect.
  - Lock the disconnect in the open position.
- Disconnect all power including external control power that may be present before servicing the drive. **WAIT 15 MINUTES** to allow the DC bus capacitors to discharge. Then follow the DC bus voltage measurement procedure given in the Installation Manual to verify that the DC voltage is less than 45 V. The drive LEDs are not accurate indicators of the absence of DC bus voltage.

**Electric shock will result in death or serious injury.**

## CAUTION

### DAMAGED EQUIPMENT

Do not operate or install any drive that appears damaged.  
**Failure to follow this instruction can result in equipment damage.**

# Documentation structure

---

The following Altivar 71 technical documents are available on the Telemecanique website ([www.telemecanique.com](http://www.telemecanique.com)) as well as on the CD-ROM supplied with the drive.

## Installation Manual

This describes how to assemble and connect the drive.

## Programming manual

This describes the functions, parameters and use of the drive terminal (integrated display terminal and graphic display terminal). The communication functions are not described in this manual, but in the manual for the bus or network used.

## Communication Parameters Manual

This manual describes:

- The drive parameters with specific information for use via a bus or communication network.
- The operating modes specific to communication (state chart).
- The interaction between communication and local control.

## Manuals for Modbus, CANopen, Ethernet, Profibus, INTERBUS, Uni-Telway, FIPIO and Modbus Plus, etc.

These manuals describe the assembly, connection to the bus or network, signaling, diagnostics, and configuration of the communication-specific parameters via the integrated display terminal or the graphic display terminal. They also describe the communication services of the protocols.

## ATV 58-58F/ATV 71 Migration Manual

This manual describes the differences between the Altivar 71 and the Altivar 58/58F and explains how to replace an Altivar 58 or 58F, including how to replace drives communicating on a bus or a network.

# Software enhancements

---

Since the Altivar ATV 71 was first launched, it has benefited from the addition of several new functions. Software version V1.1 has now been updated to V1.2. The new version can be substituted for the old one without making any changes. Although this documentation relates to version V1.2, it can still be used with version V1.1, as the update merely involves the addition of new values and parameters and none of the previous version parameters have been modified or removed. The software version is indicated on the nameplate attached to the body of the drive.

## Enhancements made to version V1.2 in comparison to V1.1

### Factory setting



**Note 1:** In version V1.1, the analog input was  $0 \pm 10$  V. For safety reasons, in the new version this input has been set to  $0 + 10$  V.

**Note 2:** In version V1.1, analog output AO1 was assigned to the motor frequency. In the new version, this output is not assigned at all.

With the exception of these two parameters, the factory settings of version V1.1 remain the same in the new version. The new functions are factory-set to disabled.

### Motor frequency range

The maximum output frequency has been extended from 1000 to 1600 Hz (depending on the drive rating and control profile).

### New parameters and functions

#### Menu **[1.2 MONITORING] (SUP-)**

Addition of internal states and values relating to the new functions described below.

#### Menu **[1.3 SETTINGS] (SEt-)**

- [\[High torque thd.\] \(ttH\)](#) page [64](#).
- [\[Low torque thd.\] \(ttL\)](#) page [64](#).
- [\[Pulse warning thd.\] \(FqL\)](#) page [65](#).
- [\[Freewheel stop Thd.\] \(FFt\)](#) page [65](#).

#### Menu **[1.4 MOTOR CONTROL] (drC-)**

- [\[rpm increment\] \(InSP\)](#) page [67](#).
- Extension of the following configurations to all drive ratings; previously limited to 45 kW (60 HP) for ATV71●●●M3X and to 75 kW (100 HP) for ATV71●●●N4: synchronous motor [\[Sync. mot.\] \(SYn\)](#) page [69](#), sinus filter [\[Sinus filter\] \(OFI\)](#) page [79](#), noise reduction [\[Noise reduction\] \(nrd\)](#) page [80](#), braking balance [\[Braking balance\] \(bbA\)](#) page [82](#).

#### Menu **[1.5 INPUTS / OUTPUTS CFG] (I-O-)**

- Input AI1 can now be configured to  $0 + 10$  V or  $0 \pm 10$  V via [\[AI1 Type\] \(AI1t\)](#) page [91](#).
- [\[AI net. channel\] \(AIC1\)](#) page [95](#).
- New methods of assigning relays and logic outputs page [100](#) : rope slack, high torque threshold, low torque threshold, motor in forward rotation, motor in reverse rotation, measured speed threshold reached, load variation detection.
- Analog output AO1 can now be used as a logic output and assigned to relay functions and logic outputs, page [105](#).
- New method of modifying the scale of analog outputs page [107](#) using the parameters [\[Scaling AOx min\] \(ASLx\)](#) and [\[Scaling AOx max\] \(ASHx\)](#).
- New methods of assigning logic outputs page [108](#): signed motor torque and measured motor speed.
- New methods of assigning alarm groups page [112](#) : rope slack, high torque threshold, low torque threshold, measured speed threshold reached, load variation detection.

# Software enhancements

---

## Menu [1.7 APPLICATION FUNCT.] (Fun-)

- The summing, subtraction and multiplication reference functions can now be assigned to virtual input [Network AI] (AIU1) page 133.
- New parameter [Freewheel stop Thd.] (FFt) page 137 used to set a threshold for switching to freewheel at the end of a stop on ramp or fast stop.
- Brake engage at regulated zero speed [Brake engage at 0] (bECd) page 158.
- Weight [Weight sensor ass.] (PES) page 163 can now be assigned to virtual input [Network AI] (AIU1).
- New "rope slack" function page 167, with the parameters [Rope slack config.] (rSd) and [Rope slack trq level] (rStL).
- Use of the ramp [Acceleration 2] (AC2) page 175 when starting and "waking up" the PID function.
- The torque limitation [TORQUE LIMITATION] (tOL-) page 182 can now be configured in whole % or in 0.1% increments using [Torque increment] (IntP) and assigned to virtual input [Network AI] (AIU1).
- New "stop at distance calculated after deceleration limit switch" function page 191, with the parameters [Stop distance] (Std), [Rated linear speed] (nLS) and [Stop corrector] (SFd).
- Positioning by sensors or limit switch [POSITIONING BY SENSORS] (LPO-) page 192 can now be configured in positive logic or negative logic using [Stop limit config. (SAL) and [Slowdown limit cfg.] (dAL).
- Parameter set switching [PARAM. SET SWITCHING] (MLP-) page 195 can now be assigned to the frequency thresholds attained [Freq. Th. att.] (FtA) and [Freq. Th. 2 attain.] (F2A).
- New half-floor: menu [HALF FLOOR] (HFF-) page 208.

## Menu [1.8 FAULT MANAGEMENT] (FLt)

- Possibility of reinitializing the drive without turning it off, via [Product reset] (rP) page 213.
- Possibility of reinitializing the drive via a logic input without turning it off, using [Product reset assign.] (rPA) page 213.
- The possibility of configuring the "output phase loss" fault [Output Phase Loss] (OPL) page 217 to [Output cut] (OAC) has been extended to all drive ratings (previously limited to 45 kW (60 HP) for ATV71●●●M3X and 75 kW (100HP) for ATV71●●●N4).
- The external fault [EXTERNAL FAULT] (EtF-) page 220 can now be configured in positive or negative logic via [External fault config.] (LEt).
- New monitoring function based on speed measurement via "Pulse input" page 227, via the [FREQUENCY METER] menu (FqF-).
- New function for detecting load variation page 229, via the [DYNAMIC LOAD DETECT] menu (dLd-).
- Short-circuit faults on the braking unit can now be configured via [Brake res. fault Mgt] bUb) page 231.

## Menu [7 DISPLAY CONFIG.]

- In [7.4 KEYPAD PARAMETERS] page 258, the [KEYPAD CONTRAST] and [KEYPAD STAND-BY] parameters to adjust the contrast and stand-by mode of the graphic display unit.

### INSTALLATION

- 1 Consult the Installation Manual



#### Tips:

- Before you start programming, complete the user setting tables, page [267](#).
- Perform an auto-tuning operation to optimize performance, page [41](#).
- If you get lost, return to the factory settings, page [243](#).



**Note:** Check that the wiring of the drive is compatible with its configuration.

### PROGRAMMING

- 2 Power up without run command
  - If you are using a separate power supply for the control section, follow the instructions on page [14](#).
- 3 Select the language, if the drive has a graphic display terminal
- 4 Configure the **[SIMPLY START]** (**5 17 -**) menu
  - 2-wire or 3-wire control
  - Macro configuration
  - Motor parameters
    - ☞ *Perform an auto-tuning operation*
  - Motor thermal current
  - Acceleration and deceleration ramps
  - Speed variation range
- 5 Start



# Factory configuration

---

## Drive factory settings

The Altivar 71 is factory-set for the most common operating conditions:

- Macro configuration: Start/Stop
- **Motor** frequency: 50 Hz
- Constant torque application, with sensorless flux vector control
- Normal stop mode on deceleration ramp
- Stop mode in the event of a fault: freewheel
- Linear, acceleration and deceleration ramps: 3 seconds
- Low speed: 0 Hz
- High speed: 50 Hz
- Motor thermal current = rated drive current
- Standstill injection braking current = 0.7 x rated drive current, for 0.5 seconds
- No automatic starts after a fault
- Switching frequency 2.5 kHz or 4 kHz depending on drive rating
- Logic inputs:
  - LI1: forward, LI2: Forward (2 operating direction), 2-wire control on transition
  - LI3, LI4, LI5, LI6: inactive (not assigned)
- Analog inputs:
  - AI1: speed reference 0 +10 V
  - AI2: 0-20 mA, inactive (not assigned)
- Relay R1: The contact opens in the event of a fault (or drive off).
- Relay R2: Inactive (not assigned)
- Analog output AO1: 0-20 mA, inactive (not assigned)

If the above values are compatible with the application, the drive can be used without changing the settings.

## Option card factory settings

The option card inputs/outputs are not factory-set.

# Application functions

The tables on the following pages show the most common combinations of functions and applications, in order to guide your selection. The applications in these tables relate to the following machines in particular:

- **Hoisting:** cranes, overhead cranes, gantries (vertical hoisting, translation, slewing), lifting platforms
- **Elevators:** elevators in retrofit up to 1.2 m/s
- **Handling:** palletizers/depalletizers, conveyors, roller tables
- **Packing:** carton packers, labeling machines
- **Textiles:** weaving looms, carding frames, washing machines, spinners, drawing frames
- **Wood:** automatic lathes, saws, milling
- **High inertia:** centrifuges, mixers, unbalanced machines (beam pumps, presses)
- **Process**

Each machine has its own special features, and the combinations listed here are neither mandatory nor exhaustive.

Some functions are designed specifically for a particular application. In this case, the application is identified by a tab in the margin on the relevant programming pages.

## Motor control functions

| Functions                             | Page                | Applications |       |          |         |          |      |              |         |
|---------------------------------------|---------------------|--------------|-------|----------|---------|----------|------|--------------|---------|
|                                       |                     | Hoisting     | Lifts | Handling | Packing | Textiles | Wood | High inertia | Process |
| V/f ratio                             | <a href="#">69</a>  |              |       | ■        |         |          | ■    | ■            |         |
| Sensorless flux vector control        | <a href="#">69</a>  | ■            | ■     | ■        | ■       | ■        | ■    | ■            | ■       |
| Flux vector control with sensor       | <a href="#">69</a>  | ■            | ■     | ■        | ■       | ■        | ■    | ■            | ■       |
| 2-point vector control                | <a href="#">69</a>  | ■            |       |          |         | ■        |      |              |         |
| Open-loop synchronous motor           | <a href="#">69</a>  |              |       |          |         | ■        |      |              |         |
| Output frequency of up to 1600 Hz     | <a href="#">67</a>  |              |       |          |         | ■        | ■    |              |         |
| Motor overvoltage limiting            | <a href="#">80</a>  |              |       |          |         | ■        | ■    |              |         |
| DC bus connection (see User's Manual) | -                   |              |       |          |         | ■        |      |              | ■       |
| Motor fluxing using a logic input     | <a href="#">150</a> | ■            |       | ■        | ■       |          |      |              |         |
| Switching frequency of up to 16 kHz   | <a href="#">79</a>  |              | ■     |          |         | ■        | ■    |              |         |
| Auto-tuning                           | <a href="#">68</a>  | ■            | ■     | ■        | ■       | ■        | ■    | ■            | ■       |

# Application functions

## Functions on speed references

| Functions   | Page                      | Applications |       |          |         |          |      |              |         |
|---|---------------------------|--------------|-------|----------|---------|----------|------|--------------|---------|
|   |                           | Hoisting     | Lifts | Handling | Packing | Textiles | Wood | High inertia | Process |
| Differential bipolar reference                              | <a href="#">88</a>        | ■            |       | ■        | ■       |          |      |              |         |
| Reference delinearization (magnifying glass effect)         | <a href="#">90</a>        | ■            |       | ■        |         |          |      |              |         |
| Frequency control input                                     | <a href="#">122</a>       |              |       |          |         | ■        |      |              | ■       |
| Reference switching   | <a href="#">123 - 132</a> |              |       |          | ■       |          |      |              |         |
| Reference summing   | <a href="#">131</a>       |              |       |          | ■       |          |      |              |         |
| Reference subtraction                                       | <a href="#">131</a>       |              |       |          | ■       |          |      |              |         |
| Reference multiplication                                    | <a href="#">131</a>       |              |       |          | ■       |          |      |              |         |
| S ramps   | <a href="#">134</a>       | ■            | ■     | ■        |         |          |      |              |         |
| Jog operation   | <a href="#">141</a>       |              |       | ■        |         | ■        |      |              | ■       |
| Preset speeds   | <a href="#">142</a>       | ■            | ■     | ■        | ■       |          |      | ■            |         |
| + speed / - speed using single action pushbuttons (1 step)  | <a href="#">145</a>       |              |       |          |         |          |      |              | ■       |
| + speed / - speed using double action pushbuttons (2 steps) | <a href="#">145</a>       | ■            |       |          |         |          |      |              |         |
| +/- speed around a reference                                | <a href="#">147</a>       |              |       |          |         | ■        |      |              | ■       |
| Save reference  | <a href="#">149</a>       |              |       |          |         |          |      |              | ■       |

# Application functions

## Application-specific functions

| Functions   | Page                | Applications |       |          |         |          |      |              |         |
|---|---------------------|--------------|-------|----------|---------|----------|------|--------------|---------|
|   |                     | Hoisting     | Lifts | Handling | Packing | Textiles | Wood | High inertia | Process |
| Fast stop   | <a href="#">137</a> |              |       |          |         |          | ■    | ■            |         |
| Limit switch management                                     | <a href="#">151</a> | ■            | ■     | ■        |         |          |      |              |         |
| Brake control   | <a href="#">153</a> | ■            | ■     | ■        |         |          |      |              |         |
| Load measurement  | <a href="#">162</a> | ■            | ■     |          |         |          |      |              |         |
| High-speed hoisting   | <a href="#">164</a> | ■            |       |          |         |          |      |              |         |
| Rope slack  | <a href="#">167</a> | ■            |       |          |         |          |      |              |         |
| PID regulator   | <a href="#">169</a> |              |       |          |         |          |      |              | ■       |
| Torque monitoring   | <a href="#">178</a> |              |       | ■        |         | ■        |      |              | ■       |
| Motor/generator torque limit                                | <a href="#">181</a> |              |       | ■        |         | ■        |      | ■            | ■       |
| Load sharing  | <a href="#">82</a>  | ■            |       | ■        |         |          |      |              |         |
| Line contactor control                                      | <a href="#">185</a> | ■            |       | ■        |         |          | ■    |              |         |
| Output contactor control                                    | <a href="#">187</a> |              | ■     |          |         |          |      |              |         |
| Positioning by limit switches or sensors                    | <a href="#">189</a> |              |       | ■        | ■       |          |      |              |         |
| Stop at distance calculated after deceleration limit switch | <a href="#">191</a> |              |       | ■        | ■       |          |      |              |         |
| ENA system (mechanical with unbalanced load)                | <a href="#">77</a>  |              |       |          |         |          |      | ■            |         |
| Parameter switching   | <a href="#">194</a> | ■            | ■     | ■        | ■       | ■        | ■    | ■            | ■       |
| Motor or configuration switching                            | <a href="#">197</a> | ■            |       | ■        | ■       |          |      |              |         |
| Traverse control  | <a href="#">200</a> |              |       |          |         | ■        |      |              |         |
| Stop configuration  | <a href="#">137</a> |              |       | ■        |         | ■        | ■    | ■            |         |
| Evacuation  | <a href="#">207</a> |              | ■     |          |         |          |      |              |         |
| Half floor  | <a href="#">208</a> |              | ■     |          |         |          |      |              |         |

# Application functions

## Safety functions/fault management

| Functions   | Page                                       | Applications |       |          |         |          |      |              |         |
|---|--|--------------|-------|----------|---------|----------|------|--------------|---------|
|   |  | Hoisting     | Lifts | Handling | Packing | Textiles | Wood | High inertia | Process |
| Power Removal (safety function, see User's Manual)                            | -  | ■            | ■     | ■        | ■       | ■        | ■    | ■            | ■       |
| Deferred stop on thermal alarm  | <a href="#">219</a>                        |              | ■     |          |         |          |      |              |         |
| Alarm handling  | <a href="#">112</a>                        | ■            | ■     | ■        | ■       | ■        | ■    | ■            | ■       |
| Fault management  | <a href="#">211</a> to <a href="#">233</a> | ■            | ■     | ■        | ■       | ■        | ■    | ■            | ■       |
| IGBT tests  | <a href="#">222</a>                        | ■            | ■     | ■        | ■       | ■        | ■    | ■            | ■       |
| Catch a spinning load   | <a href="#">215</a>                        |              |       |          |         | ■        | ■    | ■            |         |
| Braking resistor thermal protection   | <a href="#">231</a>                        | ■            | ■     | ■        | ■       |          |      |              |         |
| Motor protection with PTC probes  | <a href="#">211</a>                        | ■            | ■     | ■        | ■       | ■        | ■    | ■            | ■       |
| Undervoltage management   | <a href="#">221</a>                        |              |       |          |         | ■        | ■    | ■            |         |
| 4-20mA loss   | <a href="#">223</a>                        | ■            | ■     | ■        |         | ■        | ■    |              | ■       |
| Uncontrolled output cut (output phase loss)                                   | <a href="#">217</a>                        |              |       | ■        |         |          |      |              |         |
| Automatic restart   | <a href="#">214</a>                        |              |       | ■        |         |          |      |              |         |
| Use of the "Pulse input" input to measure the speed of rotation of the motor. | <a href="#">227</a>                        | ■            | ■     | ■        |         |          |      |              |         |
| Load variation detection  | <a href="#">229</a>                        | ■            |       |          |         |          |      |              |         |

# Setup - Preliminary recommendations

---

## Turning on and configuring the drive

|  <b>DANGER</b>   |
|---|
| <b>UNINTENDED EQUIPMENT OPERATION</b> <ul style="list-style-type: none"><li>• Before turning on and configuring the Altivar 71, check that the PWR (POWER REMOVAL) input is deactivated (at state 0) in order to prevent unintended operation.</li><li>• Before turning on the drive, or when exiting the configuration menus, check that the inputs assigned to the run command are deactivated (at state 0) since they can cause the motor to start immediately.</li></ul> <p><b>Failure to follow these instructions will result in death or serious injury.</b></p> |

| <b>CAUTION</b>   |
|--|
| <b>INCOMPATIBLE LINE VOLTAGE</b> <p>Before turning on and configuring the drive, ensure that the line voltage is compatible with the supply voltage range shown on the drive nameplate. The drive may be damaged if the line voltage is not compatible.</p> <p><b>Failure to follow this instruction can result in equipment damage.</b></p> |

## Separate control section power supply

When the drive control section is powered independently of the power section (P24 and 0V terminals), whenever an option card is added or replaced, only the power section must be supplied with power next time the drive is powered up. By default the new card would not be recognized and it would be impossible to configure it, thereby causing the drive to lock in fault mode.

## Power switching via line contactor

| <b>CAUTION</b>  |
|---|
| <ul style="list-style-type: none"><li>• <b>Avoid operating the contactor frequently (premature ageing of the filter capacitors).</b></li><li>• <b>Cycle times &lt; 60 s may result in damage to the pre-charge resistor.</b></li></ul> <p><b>Failure to follow this instruction can result in equipment damage.</b></p> |

## User adjustment and extension of functions

- The display unit and buttons can be used to modify the settings and to extend the functions described in the following pages.
- **Return to factory settings** is made easy by the [\[1.12 FACTORY SETTINGS\] \(FCS-\)](#) menu, see page [241](#).
- There are three types of parameter:
  - Display: Values displayed by the drive
  - Adjustment: Can be changed during operation or when stopped
  - Configuration: Can only be modified when stopped and no braking is taking place. Can be displayed during operation.

|  <b>DANGER</b>   |
|---|
| <b>UNINTENDED EQUIPMENT OPERATION</b> <ul style="list-style-type: none"><li>• Check that changes made to the settings during operation do not present any danger.</li><li>• We recommend stopping the drive before making any changes.</li></ul> <p><b>Failure to follow these instructions will result in death or serious injury.</b></p> |

# Setup - Preliminary recommendations

---

## Starting

### Important:

- In factory settings mode, the motor can only be supplied with power once the “forward”, “reverse” and “DC injection stop” commands have been reset:
  - On power-up or a manual fault reset or after a stop commandIf they have not been reset, the drive will display "nSt" but will not start.
- If the automatic restart function has been configured ([Automatic restart] (Atr) parameter in the [1.8-FAULT MANAGEMENT] (FLt-) menu, see page 214), these commands are taken into account without a reset being necessary.

## Test on a low power motor or without a motor

- In factory settings mode, [Output Phase Loss] detection (OPL) page 217 is active (OPL = YES). To check the drive in a test or maintenance environment without having to switch to a motor with the same rating as the drive (particularly useful in the case of high power drives), deactivate [Output Phase Loss] (OPL = no).
- Configure [Motor control type] (Ctt) = [V/F 2pts] (UF2) or [V/F 5pts] (UF5) ([1.4-MOTOR CONTROL] (drC-) menu, see page 69)

### CAUTION

- Motor thermal protection will not be provided by the drive if the motor current is less than 0.2 times the rated drive current. Provide an alternative means of thermal protection.

**Failure to follow this instruction can result in equipment damage.**

## Using motors in parallel

- Configure [Motor control type] (Ctt) = [V/F 2pts] (UF2) or [V/F 5pts] (UF5) ([1.4-MOTOR CONTROL] (drC-) menu, see page 69)

### CAUTION

- Motor thermal protection is no longer provided by the drive. Provide an alternative means of thermal protection on every motor.

**Failure to follow this instruction can result in equipment damage.**

# Graphic display terminal

Although the graphic display terminal is optional for low-power drives, it is a standard component on high-power drives (see catalog). The graphic display terminal can be disconnected and connected remotely (on the door of an enclosure for example) using the cables and accessories available as options (see catalog).

## Description of terminal

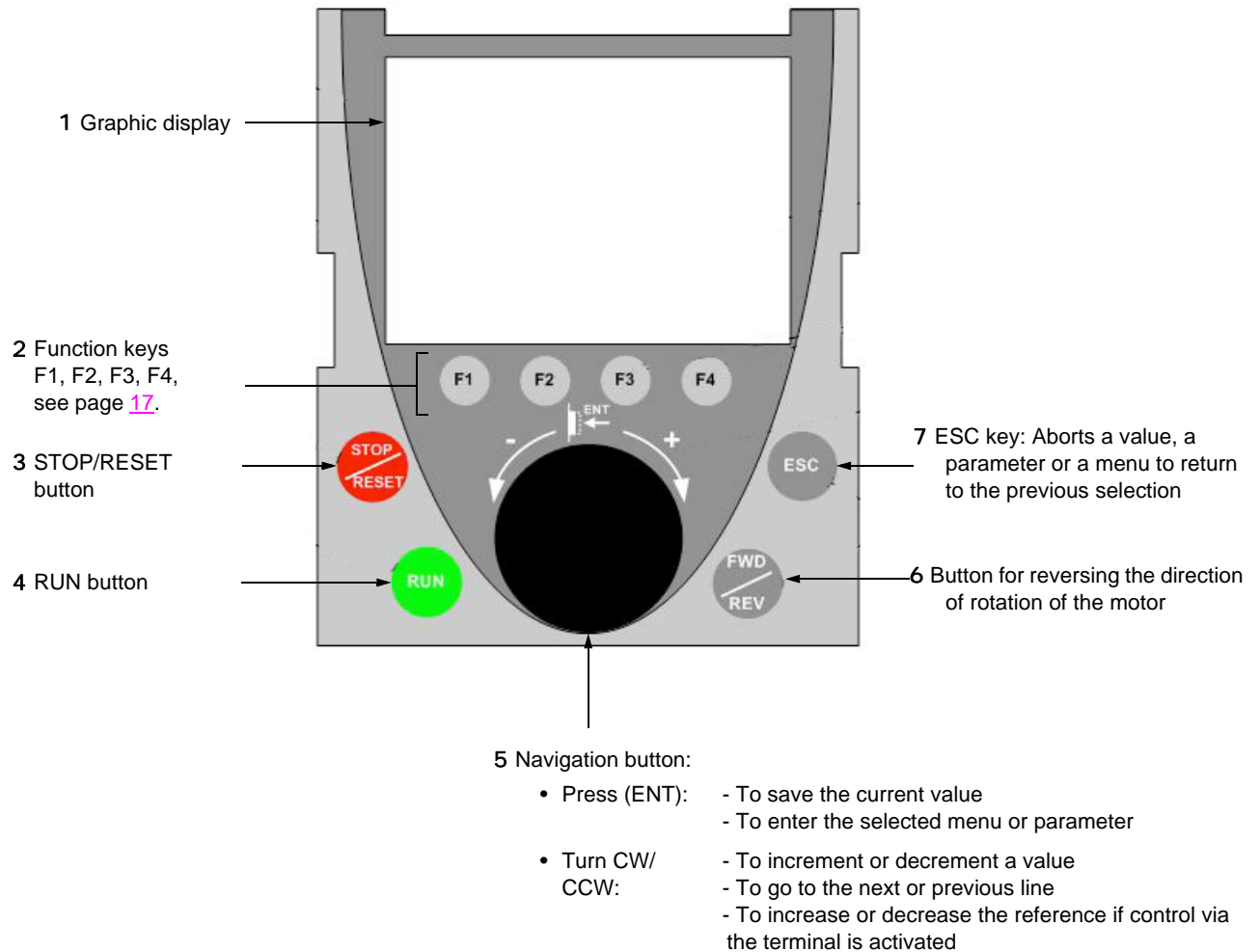

**Note:** Buttons 3, 4, 5 and 6 can be used to control the drive directly, if control via the terminal is activated.

## Disconnected terminal

When the terminal is disconnected, 2 LEDs become visible:

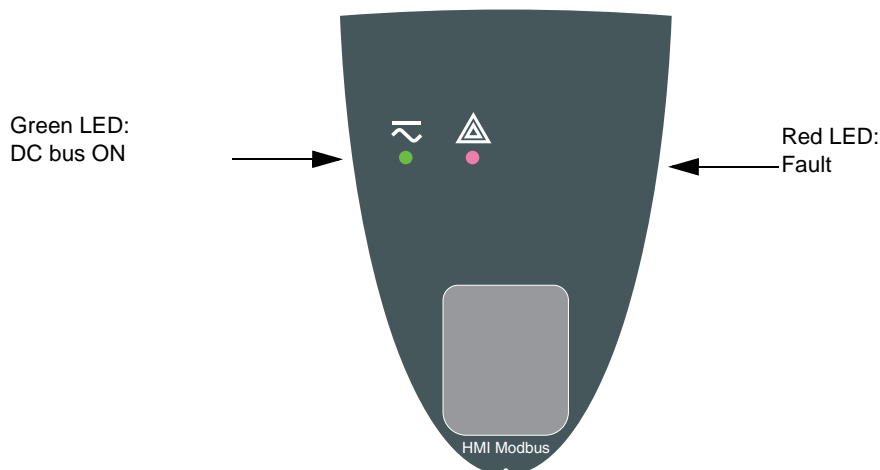



# Graphic display terminal

## Description of the graphic screen

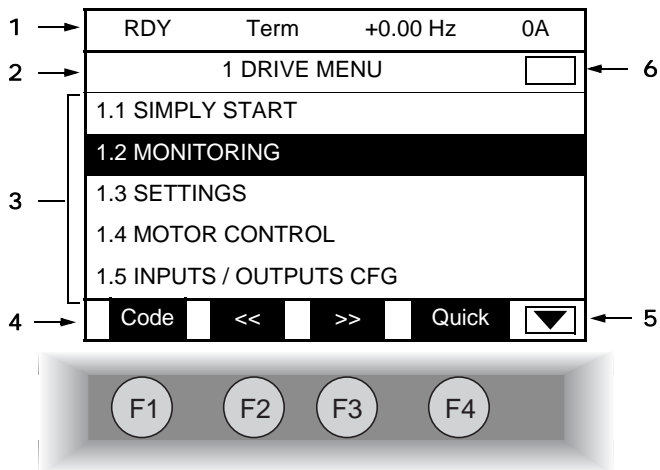

1. Display line. Its content can be configured; the factory settings show:

- The drive state (see page 18)
- The active control channel:
  - Term: Terminals
  - HMI: Graphic display terminal
  - MDB: Integrated Modbus
  - CAN: Integrated CANopen
  - NET: Communication card
  - APP: Controller Inside card
- Frequency reference
- Current in the motor

2. Menu line. Indicates the name of the current menu or submenu.

3. Menus, submenus, parameters, values, bar charts, etc., are displayed in drop-down window format on a maximum of 5 lines. The line or value selected by the navigation button is displayed in reverse video.

4. Section displaying the functions assigned to the F1 to F4 keys and aligned with them, for example:

- Code **F1** : Displays the code of the selected parameter, i.e., the code corresponding to the 7-segment display.
- HELP **F1** : Contextual help
- << **F2** : Navigate horizontally to the left, or go to previous menu/submenu or, for a value, go to the next digit up, displayed in reverse video (see the example on page 19).
- >> **F3** : Navigate horizontally to the right or go to next menu/submenu (going to the [2 ACCESS LEVEL] menu in this example) or, for a value, go to the next digit down, displayed in reverse video (see the example on page 19).
- Quick **F4** : Quick navigation, see page 23.

The function keys are dynamic and contextual.

Other functions (application functions) can be assigned to these keys via the [1.6 COMMAND] menu.

5.  Indicates that there are no more levels below this display window.  
 Indicates that there are more levels below this display window.

6.  Indicates that this display window does not scroll further up.  
 Indicates that there are more levels above this display window.

## Drive state codes:

- ACC: Acceleration
- CLI: Current limit
- CTL: Controlled stop on input phase loss
- DCB: DC injection braking in progress
- DEC: Deceleration
- FLU: Motor fluxing in progress
- FST: Fast stop
- NLP: No line power (no line supply on L1, L2, L3)
- NST: Freewheel stop
- OBR: Auto-adapted deceleration
- PRA: Power Removal function active (drive locked)
- RDY: Drive ready
- RUN: Drive running
- SOC: Controlled output cut in progress
- TUN: Auto-tuning in progress
- USA: Undervoltage alarm

# Graphic display terminal

## Example configuration windows:

|            |      |         |    |
|------------|------|---------|----|
| RDY        | Term | +0.00Hz | 0A |
| 5 LANGUAGE |      |         |    |
| English    |      |         |    |
| Français ✓ |      |         |    |
| Deutsch    |      |         |    |
| Español    |      |         |    |
| Italiano   |      |         |    |
| <<         |      | >>      |    |
|            |      | Quick   |    |
| Chinese    |      |         |    |

When only one selection is possible, the selection made is indicated by ✓  
Example: Only one language can be chosen.

|                     |                                     |
|---------------------|-------------------------------------|
| PARAMETER SELECTION |                                     |
| 1.3 SETTINGS        |                                     |
| Ramp increment      | <input checked="" type="checkbox"/> |
| Acceleration        | <input checked="" type="checkbox"/> |
| Deceleration        | <input type="checkbox"/>            |
| Acceleration 2      | <input type="checkbox"/>            |
| Deceleration 2      | <input type="checkbox"/>            |
| Edit                |                                     |

When multiple selection is possible, the selections made are indicated by   
Example: A number of parameters can be chosen to form the [USER MENU].

## Example configuration window for one value:

|              |      |             |    |
|--------------|------|-------------|----|
| RDY          | Term | +0.00Hz     | 0A |
| Acceleration |      |             |    |
| 9.51 s       |      |             |    |
| Min = 0.01   |      | Max = 99.99 |    |
| <<           |      | >>          |    |
|              |      | Quick       |    |

>>

|              |      |             |    |
|--------------|------|-------------|----|
| RDY          | Term | +0.00Hz     | 0A |
| Acceleration |      |             |    |
| 951 s        |      |             |    |
| Min = 0.01   |      | Max = 99.99 |    |
| <<           |      | >>          |    |
|              |      | Quick       |    |

The << and >> arrows (keys F2 and F3) are used to select the digit to be modified, and the navigation button is rotated to increase or decrease this number.

# Graphic display terminal

## First power-up - [5. LANGUAGE] menu

The first time the drive is powered up, the user will automatically be guided through the menus as far as [1. DRIVE MENU]. The parameters in the [1.1 SIMPLY START] submenu must be configured and auto-tuning performed before the motor is started up.



Display for 3 seconds following power-up

3 seconds

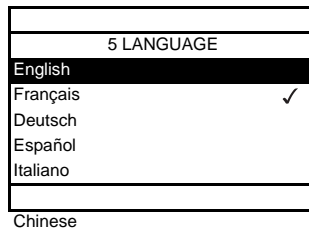

Automatically switches to [5 LANGUAGE] menu 3 seconds later.  
Select the language and press ENT.

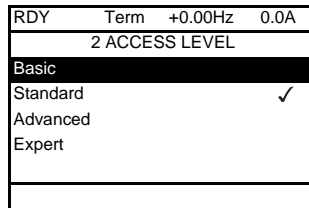

Switches to [2 ACCESS LEVEL] menu (see page 29)  
Select the access level and press ENT.

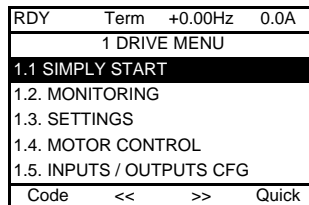

Switches to [1 DRIVE MENU] (see page 25)

ESC

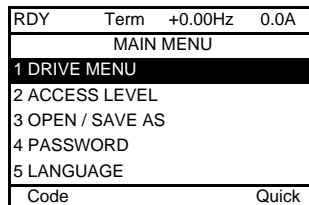

Press ESC to return to [MAIN MENU]

# Graphic display terminal

## Subsequent power ups



3 seconds ↓

|                          |      |       |       |
|--------------------------|------|-------|-------|
| RDY                      | Term | +38Hz | 0.0A  |
| 1. DRIVE MENU            |      |       |       |
| 1.1 SIMPLY START         |      |       |       |
| 1.2 MONITORING           |      |       |       |
| 1.3 SETTINGS             |      |       |       |
| 1.4 MOTOR CONTROL        |      |       |       |
| 1.5 INPUTS / OUTPUTS CFG |      |       |       |
| Code                     | <<   | >>    | Quick |

Switches to [1. DRIVE MENU] 3 seconds later.

10 seconds ↓

|                |      |        |      |
|----------------|------|--------|------|
| RDY            | Term | +38Hz  | 0.0A |
| Frequency ref. |      |        |      |
| 38 Hz          |      |        |      |
|                |      |        |      |
| Min=0          |      | Max=60 |      |
| Quick          |      |        |      |

If no operator inputs are made, switches to "Display" automatically 10 seconds later (the display will vary depending on the selected configuration).

ENT or ESC ↓

|                  |       |       |      |
|------------------|-------|-------|------|
| RDY              | Term  | +38Hz | 0.0A |
| MAIN MENU        |       |       |      |
| 1 DRIVE MENU     |       |       |      |
| 2 ACCESS LEVEL   |       |       |      |
| 3 OPEN / SAVE AS |       |       |      |
| 4 PASSWORD       |       |       |      |
| 5 LANGUAGE       |       |       |      |
| Code             | Quick |       |      |

Users can return to [MAIN MENU] by pressing ENT or ESC.

# Graphic display terminal

## Programming: Example of accessing a parameter

### Accessing the acceleration ramp

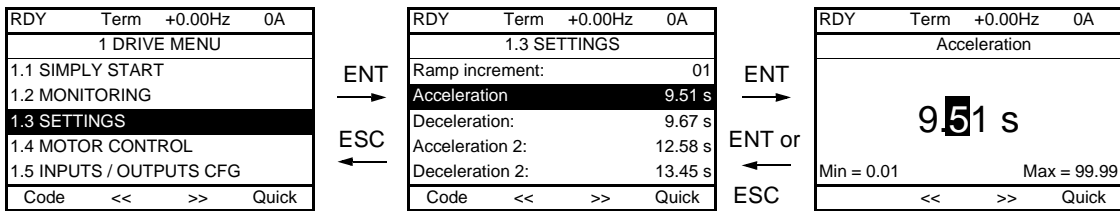

#### Note:

- To select a parameter:
  - Turn the navigation button to scroll vertically.
- To modify a parameter:
  - Use the << and >> keys (F2 and F3) to scroll horizontally and select the digit to be modified (the selected digit changes to white on a black background).
  - Turn the navigation button to modify the digit.
- To cancel the modification:
  - Press ESC.
- To save the modification:
  - Press the navigation button (ENT).

# Graphic display terminal

## Quick navigation

If the "Quick" function is displayed above the F4 key, you can gain quick access to a parameter from any screen.

### Example:

|                     |      |                  |       |
|---------------------|------|------------------|-------|
| RDY                 | Term | +0.00Hz          | 0A    |
| 1.4 MOTOR CONTROL   |      |                  |       |
| Standard mot. freq: |      | 5 0Hz IEC        |       |
| Rated motor power:  |      | 0.37 kW (0.5 HP) |       |
| Rated motor volt.:  |      | 206 V            |       |
| Rated mot. current: |      | 1.0 A            |       |
| Rated motor freq.:  |      | 50.0 Hz          |       |
| Code                | <<   | >>               | Quick |

Press F4 to access the Quick screen, which contains 4 selection options.

|                        |      |         |    |
|------------------------|------|---------|----|
| RDY                    | Term | +0.00Hz | 0A |
| QUICK NAVIGATION       |      |         |    |
| RETURN TO MAIN MENU    |      |         |    |
| DIRECT ACCESS TO...    |      |         |    |
| 10 LAST MODIFICATIONS  |      |         |    |
| GOTO MULTIPOINT SCREEN |      |         |    |
| Code                   |      |         |    |

See page [259](#)

- [HOME]: Return to [MAIN MENU].

|                  |      |         |       |
|------------------|------|---------|-------|
| RDY              | Term | +0.00Hz | 0A    |
| MAIN MENU        |      |         |       |
| 1 DRIVE MENU     |      |         |       |
| 2 ACCESS LEVEL   |      |         |       |
| 3 OPEN / SAVE AS |      |         |       |
| 4 PASSWORD       |      |         |       |
| 5 LANGUAGE       |      |         |       |
| Code             |      |         | Quick |

- [DIRECT ACCESS TO...]: Opens the direct access window, which will contain the text "1". The function keys << and >> (F2 and F3) can be used to select each of the numbers and the navigation button to increment or decrement the numbers: 1.3 in the example below.

|                     |      |         |    |
|---------------------|------|---------|----|
| RDY                 | Term | +0.00Hz | 0A |
| DIRECT ACCESS TO... |      |         |    |
| 1.3                 |      |         |    |
| SETTINGS            |      |         |    |
|                     | <<   |         | >> |

|                 |      |         |       |
|-----------------|------|---------|-------|
| RDY             | Term | +0.00Hz | 0A    |
| 1.3 SETTINGS    |      |         |       |
| Ramp increment: |      | 01      |       |
| Acceleration    |      | 9.51 s  |       |
| Deceleration:   |      | 9.67 s  |       |
| Acceleration 2: |      | 12.58 s |       |
| Deceleration 2: |      | 13.45 s |       |
| Code            | <<   | >>      | Quick |

- [10 LAST MODIFICATIONS]: Opens a window in which the last 10 parameters modified can be accessed directly.

|                       |      |         |    |
|-----------------------|------|---------|----|
| RDY                   | Term | +0.00Hz | 0A |
| 10 LAST MODIFICATIONS |      |         |    |
| Acceleration:         |      | 10 s    |    |
| ENA prop.gain:        |      | 1.2     |    |
| Rated mot. current:   |      | 15 A    |    |
| Preset speed 4:       |      | 20 Hz   |    |
| Preset speed 5:       |      | 30 Hz   |    |
| Code                  |      |         |    |

|                    |      |         |    |
|--------------------|------|---------|----|
| RDY                | Term | +0.00Hz | 0A |
| Rated mot. current |      |         |    |
| 15.0 A             |      |         |    |
|                    | <<   |         | >> |

# Graphic display terminal

## [MAIN MENU] - Menu mapping

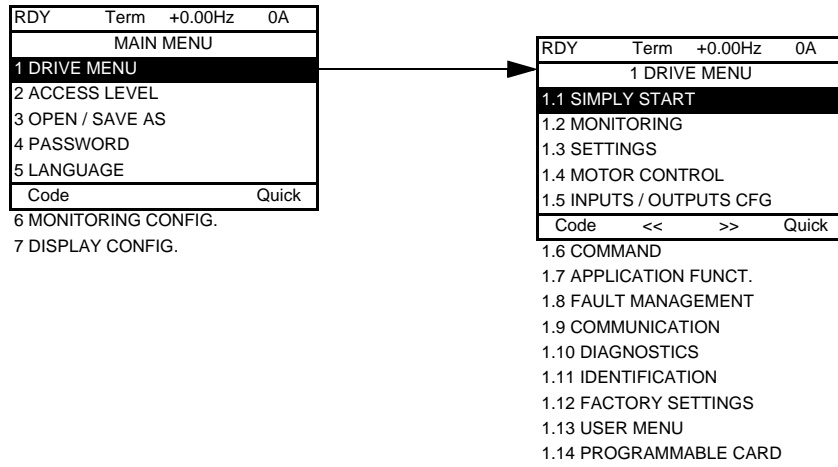

## Content of [MAIN MENU] menus

|                        |   |
|------------------------|---|
| [1 DRIVE MENU]         | See next page   |
| [2 ACCESS LEVEL]       | Defines which menus can be accessed (level of complexity)   |
| [3 OPEN / SAVE AS]     | Can be used to save and recover drive configuration files   |
| [4 PASSWORD]           | Provides password protection for the configuration  |
| [5 LANGUAGE]           | Language selection  |
| [6 MONITORING CONFIG.] | Customization of information displayed on the graphic display terminal during operation   |
| [7 DISPLAY CONFIG.]    | <ul style="list-style-type: none"> <li>• Customization of parameters</li> <li>• Creation of a customized user menu</li> <li>• Customization of the visibility and protection mechanisms for menus and parameters</li> </ul> |



# Graphic display terminal

---

## [1 DRIVE MENU]

|                          |      |         |       |
|--------------------------|------|---------|-------|
| RDY                      | Term | +0.00Hz | 0A    |
| 1 DRIVE MENU             |      |         |       |
| 1.1 SIMPLY START         |      |         |       |
| 1.2 MONITORING           |      |         |       |
| 1.3 SETTINGS             |      |         |       |
| 1.4 MOTOR CONTROL        |      |         |       |
| 1.5 INPUTS / OUTPUTS CFG |      |         |       |
| Code                     | <<   | >>      | Quick |

1.6 COMMAND  
1.7 APPLICATION FUNCT.  
1.8 FAULT MANAGEMENT  
1.9 COMMUNICATION  
1.10 DIAGNOSTICS  
1.11 IDENTIFICATION  
1.12 FACTORY SETTINGS  
1.13 USER MENU  
1.14 PROGRAMMABLE CARD

### Content of [1. DRIVE MENU] menus:

|                             |  |
|-----------------------------|--|
| [1.1 SIMPLY START]:         | Simplified menu for a quick start  |
| [1.2 MONITORING]:           | Visualization of current, motor and input/output values  |
| [1.3 SETTINGS]:             | Accesses the adjustment parameters, which can be modified during operation                       |
| [1.4 MOTOR CONTROL]:        | Motor parameters (motor nameplate, auto-tuning, switching frequency, control algorithms, etc.)   |
| [1.5 INPUTS / OUTPUTS CFG]: | I/O configuration (scaling, filtering, 2-wire control, 3-wire control, etc.)                     |
| [1.6 COMMAND]:              | Configuration of command and reference channels (graphic display terminal, terminals, bus, etc.) |
| [1.7 APPLICATION FUNCT.] :  | Configuration of application functions (e.g., preset speeds, PID, brake logic control, etc.)     |
| [1.8 FAULT MANAGEMENT]:     | Configuration of fault management  |
| [1.9 COMMUNICATION]:        | Communication parameters (fieldbus)  |
| [1.10 DIAGNOSTICS]:         | Motor/drive diagnostics  |
| [1.11 IDENTIFICATION]:      | Identifies the drive and the internal options  |
| [1.12 FACTORY SETTINGS]:    | Access to configuration files and return to factory settings                                     |
| [1.13 USER MENU]:           | Specific menu set up by the user in the [7. DISPLAY CONFIG.] menu                                |
| [1.14 PROGRAMMABLE CARD]: : | Configuration of optional Controller Inside card   |

# Integrated display terminal

Low-power Altivar 71 drives (see catalog) feature an integrated display terminal with a 7-segment 4-digit display. The graphic display terminal described on the previous pages can also be connected to these drives as an option.

## Functions of the display and the keys

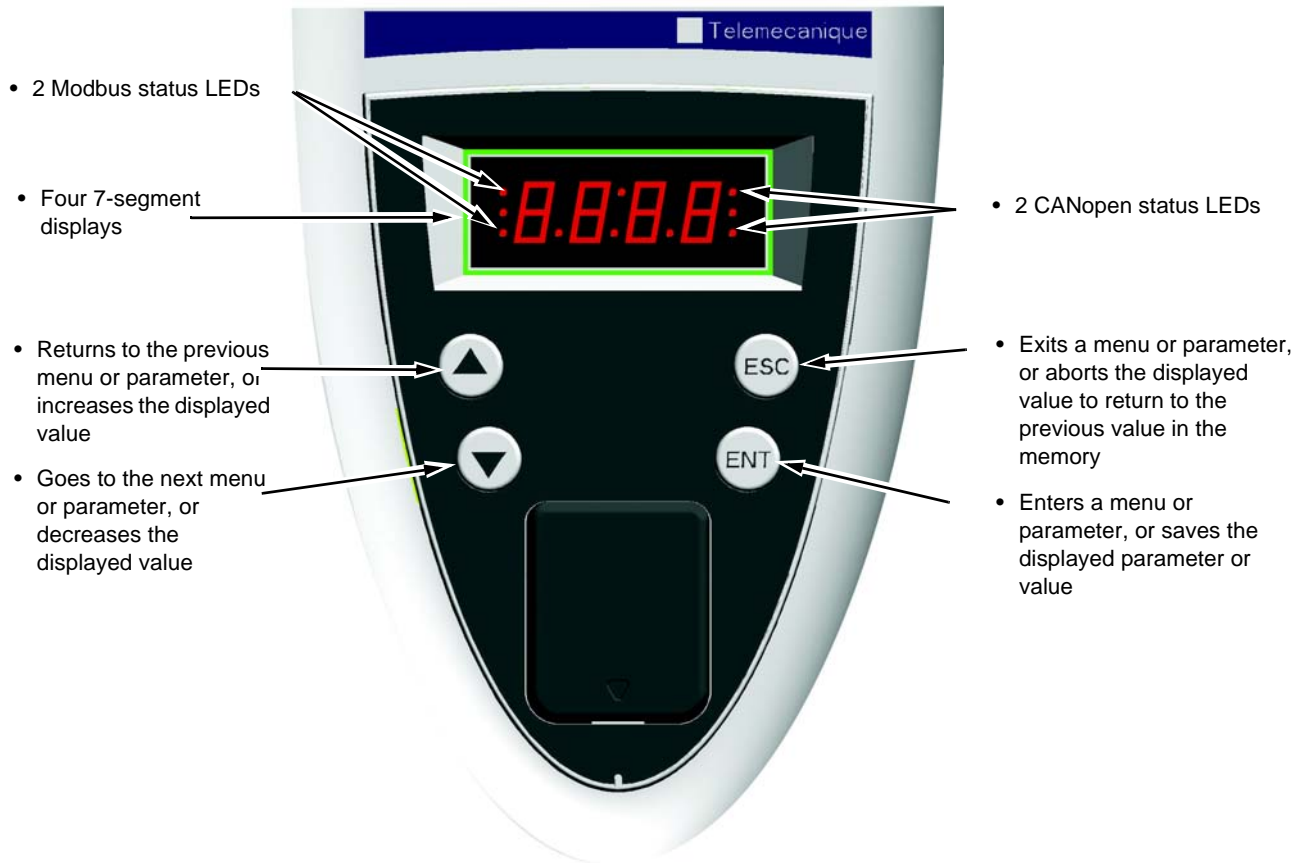

- Note:**
- Pressing ▲ or ▼ does not store the selection.
  - Press and hold down (>2 s) ▲ or ▼ to scroll through the data quickly.

### Save and store the selection: ENT

The display flashes when a value is stored.

### Normal display, with no fault present and no startup:

- 43.0 : Display of the parameter selected in the SUP menu (default selection: motor frequency)
- CL: Current limit
- CtL: Controlled stop on input phase loss
- dCb: DC injection braking in progress
- FLU: Motor fluxing in progress
- FSt: Fast stop.
- nLP: No line power (no line supply on L1, L2, L3)
- nSt: Freewheel stop
- Obr: Auto-adapted deceleration
- PrA: Power Removal function active (drive locked)
- rdY = Drive ready
- SOC: Controlled output cut in progress
- tUn: Auto-tuning in progress
- USA: Undervoltage alarm

The display flashes to indicate the presence of a fault.

# Integrated display terminal

## Accessing menus

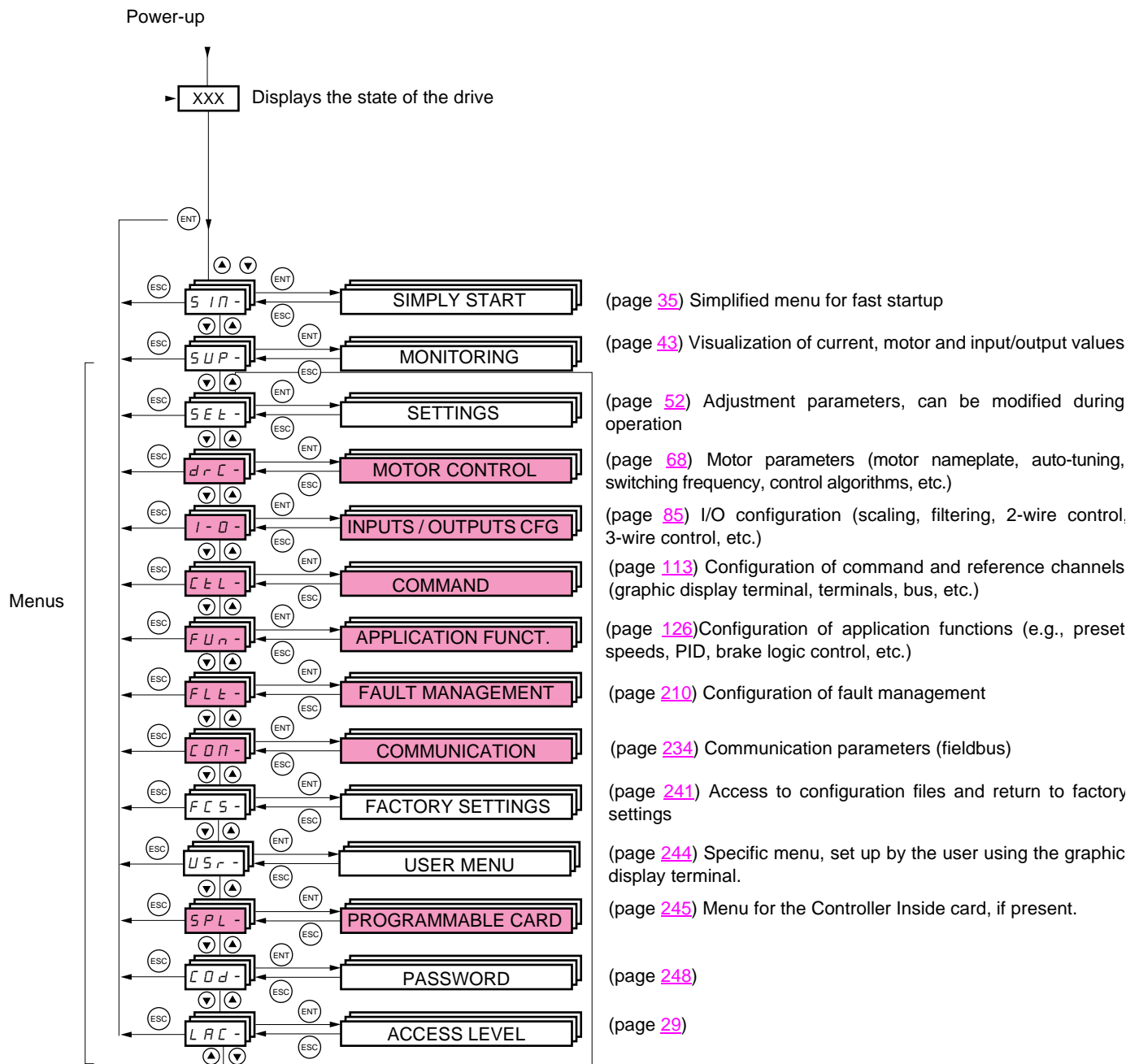

**A dash appears after menu and submenu codes to differentiate them from parameter codes.**

Examples: FUn- menu, ACC parameter.

 The grayed-out menus may not be accessible depending on the control access (LAC) configuration.

# Integrated display terminal

## Accessing menu parameters

Save and store the displayed selection : **ENT**

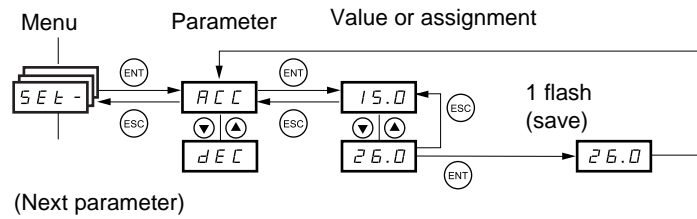

The display flashes when a value is stored.

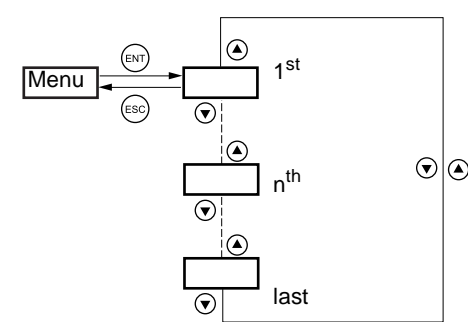

All the menus are "drop-down" type menus, which means that after the last parameter, if you continue to press ▼, you will return to the first parameter and, conversely, you can switch from the first parameter to the last parameter by pressing ▲.

## Selection of multiple assignments for one parameter

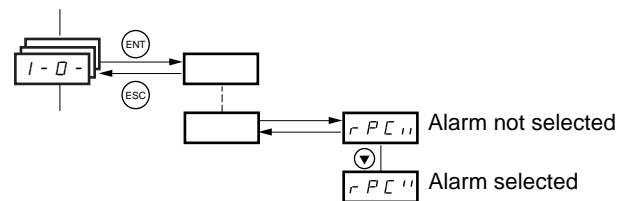

Example: List of group 1 alarms in [\[INPUTS / OUTPUTS CFG\] menu \(I-O-\)](#)

A number of alarms can be selected by "checking" them as follows.

The digit on the right indicates:  selected

 not selected.

The same principle is used for all multiple selections.

## [2. ACCESS LEVEL] (LAC-)

### With graphic display terminal

#### Basic

Access to 5 menus only, and access to 6 submenus only in the [1. DRIVE MENU] menu.

A single function can be assigned to each input.

| RDY            | Term | +0.00Hz  | 0A |
|----------------|------|----------|----|
| 2 ACCESS LEVEL |      |          |    |
| <b>Basic</b>   |      |          |    |
| Standard       |      |          | ✓  |
| Advanced       |      |          |    |
| Expert         |      |          |    |
| <<             |      | >> Quick |    |

| RDY                 | Term | +0.00Hz  | 0A |
|---------------------|------|----------|----|
| MAIN MENU           |      |          |    |
| <b>1 DRIVE MENU</b> |      |          |    |
| 2 ACCESS LEVEL      |      |          |    |
| 3 OPEN / SAVE AS    |      |          |    |
| 4 PASSWORD          |      |          |    |
| 5 LANGUAGE          |      |          |    |
| Code                |      | >> Quick |    |

| RDY                     | Term | +0.00Hz  | 0A |
|-------------------------|------|----------|----|
| 1. DRIVE MENU           |      |          |    |
| <b>1.1 SIMPLY START</b> |      |          |    |
| 1.2. MONITORING         |      |          |    |
| 1.3. SETTINGS           |      |          |    |
| 1.11. IDENTIFICATION    |      |          |    |
| 1.12. FACTORY SETTINGS  |      |          |    |
| Code                    |      | >> Quick |    |
| 1.13 USER MENU          |      |          |    |

#### Standard

This is the factory-set level. Access to 6 menus only, and access to all submenus in the [1. DRIVE MENU] menu.

A single function can be assigned to each input.

| RDY                  | Term | +0.00Hz | 0A |
|----------------------|------|---------|----|
| MAIN MENU            |      |         |    |
| <b>1 DRIVE MENU</b>  |      |         |    |
| 2 ACCESS LEVEL       |      |         |    |
| 3 OPEN / SAVE AS     |      |         |    |
| 4 PASSWORD           |      |         |    |
| 5 LANGUAGE           |      |         |    |
| Code                 |      | Quick   |    |
| 6 MONITORING CONFIG. |      |         |    |

| RDY                      | Term | +0.00Hz  | 0A |
|--------------------------|------|----------|----|
| 1 DRIVE MENU             |      |          |    |
| <b>1.1 SIMPLY START</b>  |      |          |    |
| 1.2 MONITORING           |      |          |    |
| 1.3 SETTINGS             |      |          |    |
| 1.4 MOTOR CONTROL        |      |          |    |
| 1.5 INPUTS / OUTPUTS CFG |      |          |    |
| Code                     |      | >> Quick |    |
| 1.6 COMMAND              |      |          |    |
| 1.7 APPLICATION FUNCT.   |      |          |    |
| 1.8 FAULT MANAGEMENT     |      |          |    |
| 1.9 COMMUNICATION        |      |          |    |
| 1.10 DIAGNOSTICS         |      |          |    |
| 1.11 IDENTIFICATION      |      |          |    |
| 1.12 FACTORY SETTINGS    |      |          |    |
| 1.13 USER MENU           |      |          |    |
| 1.14 PROGRAMMABLE CARD   |      |          |    |

#### Advanced

Access to all menus and submenus.

Several functions can be assigned to each input.

| RDY                  | Term | +0.00Hz | 0A |
|----------------------|------|---------|----|
| MAIN MENU            |      |         |    |
| <b>1 DRIVE MENU</b>  |      |         |    |
| 2 ACCESS LEVEL       |      |         |    |
| 3 OPEN / SAVE AS     |      |         |    |
| 4 PASSWORD           |      |         |    |
| 5 LANGUAGE           |      |         |    |
| Code                 |      | Quick   |    |
| 6 MONITORING CONFIG. |      |         |    |
| 7 DISPLAY CONFIG.    |      |         |    |

#### Expert

Access to all menus and submenus as for [Advanced] level, and access to additional parameters.

Several functions can be assigned to each input.

| RDY                  | Term | +0.00Hz | 0A |
|----------------------|------|---------|----|
| MAIN MENU            |      |         |    |
| <b>1 DRIVE MENU</b>  |      |         |    |
| 2 ACCESS LEVEL       |      |         |    |
| 3 OPEN / SAVE AS     |      |         |    |
| 4 PASSWORD           |      |         |    |
| 5 LANGUAGE           |      |         |    |
| Code                 |      | Quick   |    |
| 6 MONITORING CONFIG. |      |         |    |
| 7 DISPLAY CONFIG.    |      |         |    |

## [2. ACCESS LEVEL] (LAC-)

With integrated display terminal:

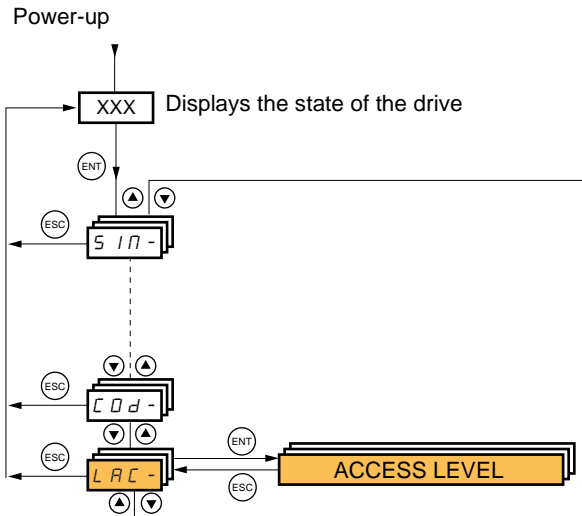

| Code           | Name/Description  | Factory setting |
|----------------|---|-----------------|
| <i>L A C -</i> |   | Std             |
| <i>b A S</i>   | <ul style="list-style-type: none"> <li>• bAS: Limited access to SIM, SUP, SEt, FCS, USr, COd and LAC menus. Only one function can be assigned to each input.</li> </ul>                               |                 |
| <i>S t d</i>   | <ul style="list-style-type: none"> <li>• Std: Access to all menus on the integrated display terminal. Only one function can be assigned to each input.</li> </ul>                                     |                 |
| <i>A d U</i>   | <ul style="list-style-type: none"> <li>• AdU: Access to all menus on the integrated display terminal. Several functions can be assigned to each input.</li> </ul>                                     |                 |
| <i>E P r</i>   | <ul style="list-style-type: none"> <li>• EPr: Access to all menus on the integrated display terminal and access to additional parameters. Several functions can be assigned to each input.</li> </ul> |                 |

## [2. ACCESS LEVEL] (LAC-)

### Comparison of the menus that can be accessed on the graphic display terminal/ integrated display terminal

| Graphic display terminal  | Integrated display terminal   | Access level |          |          |        |
|---|---|--------------|----------|----------|--------|
|   |   | Basic        | Standard | Advanced | Expert |
| <p>[2 ACCESS LEVEL]<br/>[3 OPEN/SAVE AS]<br/>[4 PASSWORD]<br/>[5 LANGUAGE]<br/>[1 DRIVE MENU]      [1.1 SIMPLY START]<br/>                                 [1.2 MONITORING]<br/>                                 [1.3 SETTINGS]<br/>                                 [1.11 IDENTIFICATION]<br/>                                 [1.12 FACTORY SETTINGS]<br/>                                 [1.13 USER MENU]</p> <p>A single function can be assigned to each input.</p> | <p><b>L A C</b> - (Access level)<br/>-<br/><b>C P W</b> - (Password)<br/>-<br/><b>S I N</b> - (Simply start)<br/><b>S U P</b> - (Monitoring)<br/><b>S E T</b> - (Settings)<br/>-<br/><b>F C S</b> - (Factory settings)<br/><b>U S r</b> - (User menu)</p> <p>A single function can be assigned to each input.</p>                                 | Basic        | Standard | Advanced | Expert |
| <p>[1.4 MOTOR CONTROL]<br/>[1.5 INPUTS / OUTPUTS CFG]<br/>[1.6 COMMAND]<br/>[1.7 APPLICATION FUNCT.]<br/>[1.8 FAULT MANAGEMENT]<br/>[1.9 COMMUNICATION]<br/>[1.10 DIAGNOSTICS]<br/>[1.14 PROGRAMMABLE CARD] (1)</p> <p>[6 MONITORING CONFIG.]</p> <p>A single function can be assigned to each input.</p>   | <p><b>d r C</b> - (Motor control)<br/><b>I - O</b> - (I/O configuration)<br/><b>C L L</b> - (Command)<br/><b>F U n</b> - (Application functions)<br/><b>F L t</b> - (Fault management)<br/><b>C O m</b> - (Communication)<br/>-<br/><b>P L C</b> - (Controller Inside card) (1)<br/>-</p> <p>A single function can be assigned to each input.</p> |              |          |          |        |
| <p>[7 DISPLAY CONFIG.]</p> <p>Several functions can be assigned to each input.</p>  | <p>-</p> <p>Several functions can be assigned to each input.</p>  |              |          |          |        |
| <p>Expert parameters</p> <p>Several functions can be assigned to each input.</p>  | <p>Expert parameters</p> <p>Several functions can be assigned to each input.</p>  |              |          |          |        |

(1) Can be accessed if the Controller Inside card is present.

# Structure of parameter tables

The parameter tables in the descriptions of the various menus can be used with both the graphic display terminal and the integrated display terminal. They, therefore, contain information for these two terminals in accordance with the description below.

**Example:**

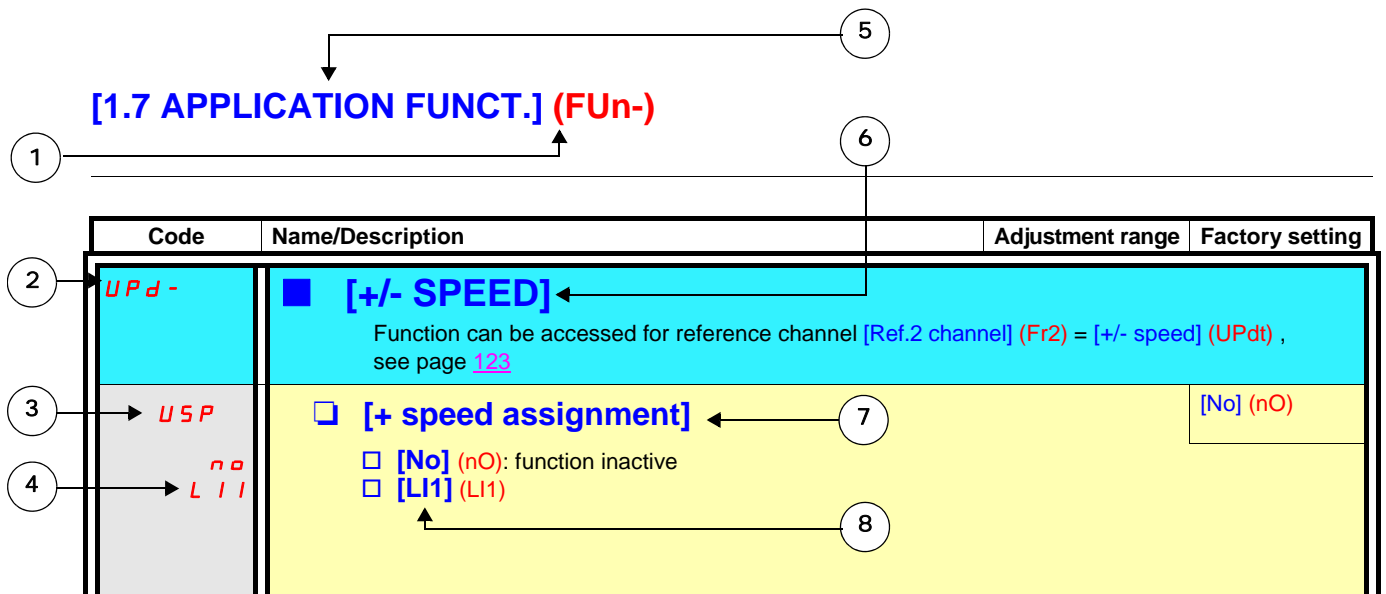

- |  |  |
|--|--|
| 1. Name of menu on 4-digit 7-segment display.    | 5. Name of menu on graphic display terminal.       |
| 2. Submenu code on 4-digit 7-segment display.    | 6. Name of submenu on graphic display terminal.    |
| 3. Parameter code on 4-digit 7-segment display.  | 7. Name of parameter on graphic display terminal.  |
| 4. Parameter value on 4-digit 7-segment display. | 8. Value of parameter on graphic display terminal. |



**Note :**

- The text in square brackets [ ] indicates what you will see on the graphic display terminal.
- The factory settings correspond to [Macro configuration] (CFG) = [Start/Stop] (StS). This is the macro configuration set at the factory.



# Interdependence of parameter values

---

The configuration of certain parameters modifies the adjustment range of other parameters, in order to reduce the risk of errors. **This may result in the modification of a factory setting or a value you have already selected.**

## Example:

1. [Current Limitation] (CLI) page 59 set to 1.6 In or left at its factory setting, 1.5 In
2. [Switching freq.] (SFr) page 59 set to 1 kHz (and confirmed with "ENT") restricts [Current Limitation] (CLI) to 1.36 In
3. If [Switching freq.] (SFr) is increased to 4 kHz, [Current limitation] (CLI) is no longer restricted, **but remains at 1.36 In**. If you require 1.6 In, you must **reset** [Current Limitation] (CLI).

# Finding a parameter in this document

---

The following assistance with finding explanations on a parameter is provided:

- **With the integrated display terminal:** Direct use of the parameter code index, page [270](#), to find the page giving details of the displayed parameter.
- **With the graphic display terminal:** Select the required parameter and press **F1** : [Code]. The parameter code is displayed instead of its name while the key is held down.

Example: ACC

|                 |      |         |       |
|-----------------|------|---------|-------|
| RDY             | Term | +0.00Hz | 0A    |
| 1.3 SETTINGS    |      |         |       |
| Ramp increment: |      |         | 01    |
| Acceleration    |      | 9.51 s  |       |
| Deceleration:   |      | 9.67 s  |       |
| Acceleration 2: |      | 12.58 s |       |
| Deceleration 2: |      | 13.45 s |       |
| Code            | <<   | >>      | Quick |

Code  
→

|                 |      |         |       |
|-----------------|------|---------|-------|
| RDY             | Term | +0.00Hz | 0A    |
| 1.3 SETTINGS    |      |         |       |
| Ramp increment: |      |         | 01    |
| ACC             |      | 9.51 s  |       |
| Deceleration:   |      | 9.67 s  |       |
| Acceleration 2: |      | 12.58 s |       |
| Deceleration 2: |      | 13.45 s |       |
| Code            | <<   | >>      | Quick |

Then use the parameter code index, page [270](#), to find the page giving details of the displayed parameter.

## [1.1 SIMPLY START] (SIM-)

With graphic display terminal:

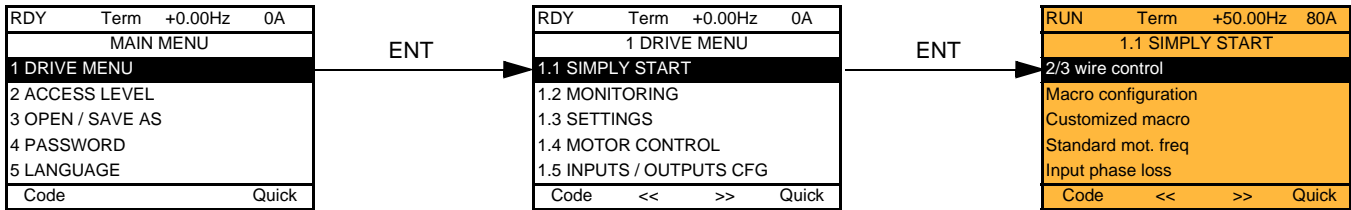

With integrated display terminal:

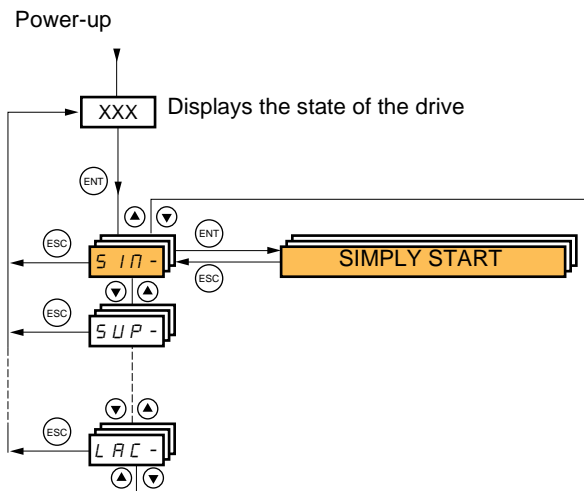

The [1.1-SIMPLY START] (SIM-) menu can be used for fast startup, which is sufficient for the majority of applications.

The parameters in this menu can only be modified when the drive is stopped and no run command is present, with the following exceptions:

- Auto-tuning, which causes the motor to start up
- The adjustment parameters on page 42



**Note :** The parameters of the [1.1 SIMPLY START] (SIM-) menu must be entered in the order in which they appear, as the later ones are dependent on the first ones.

For example [2/3 wire control] (tCC) must be configured before any other parameters.

The [1.1 SIMPLY START] (SIM-) menu should be configured **on its own or before the other drive configuration menus**. If a modification has previously been made to any of them, in particular in [1.4 MOTOR CONTROL] (drC-), some [1.1 SIMPLY START] (SIM-) parameters may be changed, for example, the motor parameters, if a synchronous motor has been selected. Returning to the [1.1 SIMPLY START] (SIM-) menu after modifying another drive configuration menu **is unnecessary** but does not pose any risk. Changes following modification of another configuration menu **are not described**, to avoid unnecessary complication in this section.

## Macro configuration

Macro configuration provides a means of speeding up the configuration of functions for a specific field of application.

7 macro configurations are available:

- Start/stop (factory configuration)
- Handling
- General use
- Hoisting
- PID regulator
- Communication bus
- Master/slave

Selecting a macro configuration assigns the parameters in this macro configuration.

Each macro configuration can still be modified in the other menus.

## [1.1 SIMPLY START] (SIM-)

### Macro configuration parameters

#### Assignment of the inputs/outputs

| Input/output                  | [Start/Stop]    | [M. handling]     | [Gen. Use]          | [Hoisting]       | [PID regul.]                    | [Network C.]  | [Mast./ slave]      |
|-------------------------------|-----------------|-------------------|---------------------|------------------|---------------------------------|---|---------------------|
| AI1                           | [Ref.1 channel] | [Ref.1 channel]   | [Ref.1 channel]     | [Ref.1 channel]  | [Ref.1 channel] (PID reference) | [Ref.2 channel] ([Ref.1 channel] = integrated Modbus) (1) | [Ref.1 channel]     |
| AI2                           | [No]            | [Summing ref. 2]  | [Summing ref. 2]    | [No]             | [PID feedback]                  | [No]  | [Torque reference]  |
| AO1                           | [No]            | [No]              | [No]                | [No]             | [No]                            | [No]  | [No]                |
| R1                            | [No drive flt]  | [No drive flt]    | [No drive flt]      | [No drive flt]   | [No drive flt]                  | [No drive flt]  | [No drive flt]      |
| R2                            | [No]            | [No]              | [No]                | [Brk control]    | [No]                            | [No]  | [No]                |
| LI1 (2-wire)                  | [Forward]       | [Forward]         | [Forward]           | [Forward]        | [Forward]                       | [Forward]   | [Forward]           |
| LI2 (2-wire)                  | [Reverse]       | [Reverse]         | [Reverse]           | [Reverse]        | [Reverse]                       | [Reverse]   | [Reverse]           |
| LI3 (2-wire)                  | [No]            | [2 preset speeds] | [Jog]               | [Fault reset]    | [PID integral reset]            | [Ref. 2 switching]  | [Trq/spd switching] |
| LI4 (2-wire)                  | [No]            | [4 preset speeds] | [Fault reset]       | [External fault] | [2 preset PID ref.]             | [Fault reset]   | [Fault reset]       |
| LI5 (2-wire)                  | [No]            | [8 preset speeds] | [Torque limitation] | [No]             | [4 preset PID ref.]             | [No]  | [No]                |
| LI6 (2-wire)                  | [No]            | [Fault reset]     | [No]                | [No]             | [No]                            | [No]  | [No]                |
| LI1 (3-wire)                  | Stop            | Stop              | Stop                | Stop             | Stop                            | Stop  | Stop                |
| LI2 (3-wire)                  | [Forward]       | [Forward]         | [Forward]           | [Forward]        | [Forward]                       | [Forward]   | [Forward]           |
| LI3 (3-wire)                  | [Reverse]       | [Reverse]         | [Reverse]           | [Reverse]        | [Reverse]                       | [Reverse]   | [Reverse]           |
| LI4 (3-wire)                  | [No]            | [2 preset speeds] | [Jog]               | [Fault reset]    | [PID integral reset]            | [Ref. 2 switching]  | [Trq/spd switching] |
| LI5 (3-wire)                  | [No]            | [4 preset speeds] | [Fault reset]       | [External fault] | [2 preset PID ref.]             | [Fault reset]   | [Fault reset]       |
| LI6 (3-wire)                  | [No]            | [8 preset speeds] | [Torque limitation] | [No]             | [4 preset PID ref.]             | [No]  | [No]                |
| Option cards                  |                 |                   |                     |                  |                                 |   |                     |
| LI7 to LI14                   | [No]            | [No]              | [No]                | [No]             | [No]                            | [No]  | [No]                |
| LO1 to LO4                    | [No]            | [No]              | [No]                | [No]             | [No]                            | [No]  | [No]                |
| R3/R4                         | [No]            | [No]              | [No]                | [No]             | [No]                            | [No]  | [No]                |
| AI3, AI4                      | [No]            | [No]              | [No]                | [No]             | [No]                            | [No]  | [No]                |
| RP                            | [No]            | [No]              | [No]                | [No]             | [No]                            | [No]  | [No]                |
| AO2                           | [I motor]       | [I motor]         | [I motor]           | [I motor]        | [I motor]                       | [I motor]   | [I motor]           |
| AO3                           | [No]            | [Sign. torque]    | [No]                | [Sign. torque]   | [PID Output]                    | [No]  | [Motor freq.]       |
| Graphic display terminal keys |                 |                   |                     |                  |                                 |   |                     |
| F1 key                        | [No]            | [No]              | [No]                | [No]             | [No]                            | Control via graphic display terminal                      | [No]                |
| F2, F3, F4 keys               | [No]            | [No]              | [No]                | [No]             | [No]                            | [No]  | [No]                |

In 3-wire control, the assignment of inputs LI1 to LI6 shifts.

(1) To start with integrated Modbus [Modbus Address] (Add) must first be configured, page 236.

**Note:** These assignments are reinitialized every time the macro configuration changes.

## [1.1 SIMPLY START] (SIM-)

---

### Macro configuration parameters

#### Other configurations and settings

In addition to the assignment of inputs/outputs, other parameters are assigned only in the Hoisting and Mast./slave macro configurations.

##### Hoisting:

- [Movement type] (bSt) = [Hoisting] (UEr) page 157
- [Brake contact] (bCl) = [No] (nO) page 157
- [Brake impulse] (bIP) = [No] (nO) page 157
- [Brake release I FW] (lbr) = [Rated mot. current] (nCr) page 157
- [Brake Release time] (brt) = 0.5 s page 158
- [Brake release freq] (blr) = [Auto] (AUtO) page 158
- [Brake engage freq] (bEn) = [Auto] (AUtO) page 158
- [Brake engage time] (bEt) = 0.5 s page 158
- [Engage at reversal] (bEd) = [No] (nO) page 159
- [Jump at reversal] (JdC) = [Auto] (AUtO) page 159
- [Time to restart] (ttr) = 0 s page 159
- [Current ramp time] (brr) = 0 s page 161
- [Low speed] (LSP) = Rated motor slip calculated by the drive, page 42
- [Output Phase Loss] (OPL) = [Yes] (YES) page 217. No further modifications can be made to this parameter.
- [Catch on the fly] (FLr) = [No] (nO) page 215. No further modifications can be made to this parameter.

##### Mast./slave:

- [Motor control type] (Ctt) = [SVC I] (CUC) page 69

**Note:** These assignments are forced every time the macro configuration changes, except for [Motor control type] (Ctt) for the Mast./slave macro configuration, if it is configured in [FVC] (FUC).

##### Return to factory settings:

Returning to factory settings with [Config. Source] (FCSI) = [Macro-Conf] (InI) page 243 will return the drive to the selected macro configuration. The [Macro configuration] (CFG) parameter does not change, although [Customized macro] (CCFG) disappears.



##### Note :

- The factory settings that appear in the parameter tables correspond to [Macro configuration] (CFG) = [Start/Stop] (StS). This is the macro configuration set at the factory.

## [1.1 SIMPLY START] (SIM-)

### Example diagrams for use with the macro configurations

#### [Hoisting] (HSt) diagram

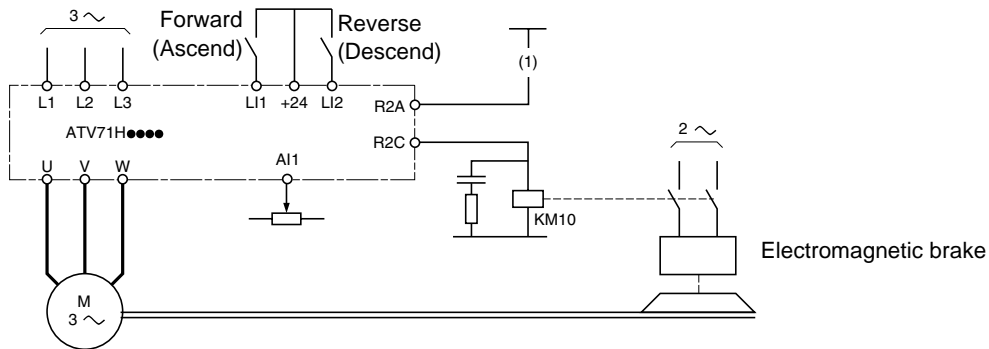

(1) A contact on the Preventa module must be inserted in the brake control circuit to engage it safely when the "Power Removal" safety function is activated (see connection diagrams in the Installation Manual).

#### [Mast./slave] (MSL) diagram

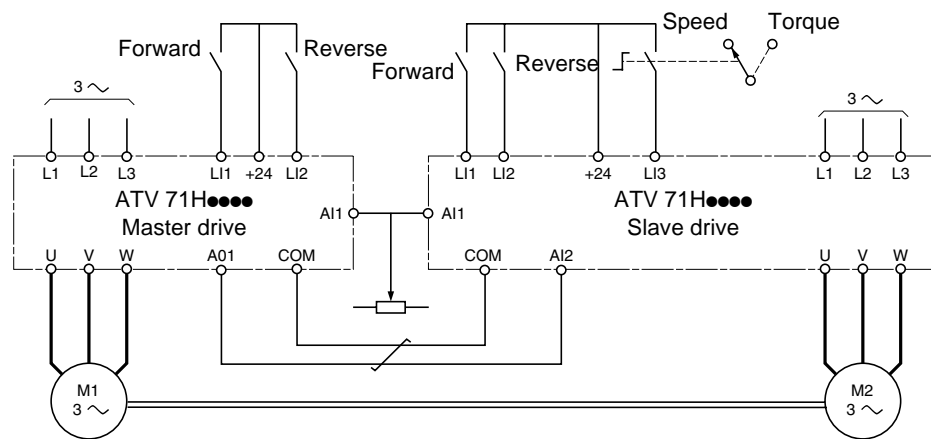

When the two motors are mechanically connected, the Speed/torque contact closing results in operation in Mast./slave mode. The master drive regulates the speed and controls the slave drive in torque mode to ensure distribution of the load.

# [1.1 SIMPLY START] (SIM-)

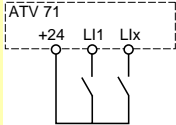
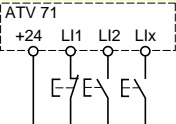
| Code  | Name/Description   | Adjustment range | Factory setting    |
|---|--|------------------|--------------------|
| <p><b>tCC</b></p> <p>2C<br/>3C</p>  | <p><input type="checkbox"/> <b>[2/3 wire control]</b></p> <p><input type="checkbox"/> [2 wire] (2C)<br/><input type="checkbox"/> [3 wire] (3C)</p> <p>2-wire control: This is the input state (0 or 1) or edge (0 to 1 or 1 to 0), which controls running or stopping.</p> <p>Example of "source" wiring:</p>  <p>L1: forward<br/>Llx: reverse</p> <p>3-wire control (pulse commands): A "forward" or "reverse" pulse is sufficient to command starting, a "stop" pulse is sufficient to command stopping.</p> <p>Example of "source" wiring:</p>  <p>L1: stop<br/>L12: forward<br/>Llx: reverse</p> |                  | [2 wire] (2C)      |
| <p><b>⚠ WARNING</b></p> <p><b>UNINTENDED EQUIPMENT OPERATION</b></p> <p>To change the assignment of [2/3 wire control] (tCC) press and hold down the "ENT" key for 2 s. The following function will be returned to factory settings: [2 wire type] (tCt) page 86 as will all functions which assign logic inputs. The macro configuration selected will also be reset if it has been customized (loss of custom settings). Check that this change is compatible with the wiring diagram used.</p> <p><b>Failure to follow these instructions can result in death or serious injury.</b></p> |  |                  |                    |
| <p><b>CFG</b></p> <p>StS<br/>HdG<br/>HSt<br/>GEn<br/>PId<br/>nEt<br/>MSL</p>  | <p><input type="checkbox"/> <b>[Macro configuration]</b></p> <p><input type="checkbox"/> [Start/Stop] (StS): Start/stop<br/><input type="checkbox"/> [M. handling] (HdG): Handling<br/><input type="checkbox"/> [Hoisting] (HSt): Hoisting<br/><input type="checkbox"/> [Gen. Use] (GEn): General use<br/><input type="checkbox"/> [PID regul.] (PId): PID regulation<br/><input type="checkbox"/> [Network C.] (nEt): Communication bus<br/><input type="checkbox"/> [Mast./slave] (MSL): Master/slave</p>  |                  | [Start/Stop] (StS) |
| <p><b>⚠ WARNING</b></p> <p><b>UNINTENDED EQUIPMENT OPERATION</b></p> <p>To change the assignment of [Macro configuration] (CFG) press and hold down the "ENT" key for 2 s. Check that the selected macro configuration is compatible with the wiring diagram used.</p> <p><b>Failure to follow these instructions can result in death or serious injury.</b></p>  |  |                  |                    |
| <p><b>CCFG</b></p> <p>YES</p>   | <p><input type="checkbox"/> <b>[Customized macro]</b></p> <p>Read-only parameter, only visible if at least one macro configuration parameter has been modified.</p> <p><input type="checkbox"/> [Yes] (YES)</p>  |                  |                    |

## [1.1 SIMPLY START] (SIM-)

| Code                    | Name/Description  | Adjustment range          | Factory setting   |
|-------------------------|---|---------------------------|---|
| <b>bFr</b><br>50<br>60  | <input type="checkbox"/> <b>[Standard mot. freq]</b><br><br><input type="checkbox"/> <b>[50Hz IEC] (50)</b> : IEC<br><input type="checkbox"/> <b>[60Hz NEMA] (60)</b> : NEMA<br>This parameter modifies the presets of the following parameters: <b>[Rated motor volt.] (UnS)</b> below, <b>[High speed] (HSP)</b> page 42, <b>[Freq. threshold] (Ftd)</b> page 65, <b>[Rated motor freq.] (FrS)</b> and <b>[Max frequency] (tFr)</b> .   |                           | <b>[50Hz IEC] (50)</b>  |
| <b>IPL</b><br>n0<br>YES | <input type="checkbox"/> <b>[Input phase loss]</b><br><br><input type="checkbox"/> <b>[Ignore] (n0)</b> : Fault ignored, to be used when the drive is supplied via a single-phase supply or by the DC bus.<br><input type="checkbox"/> <b>[Freewheel] (YES)</b> : Fault, with freewheel stop.<br>If one phase disappears, the drive switches to fault mode <b>[Input phase loss] (IPL)</b> , but if 2 or 3 phases disappear, the drive continues to operate until it trips on an undervoltage fault.<br><br>This parameter is only accessible in this menu on ATV71H037M3 to HU75M3 drives (used with a single phase supply).   |                           | According to drive rating                                       |
| <b>nPr</b>              | <input type="checkbox"/> <b>[Rated motor power]</b><br><br>Rated motor power given on the nameplate, in kW if <b>[Standard mot. freq] (bFr) = [50Hz IEC] (50)</b> , in HP if <b>[Standard mot. freq] (bFr) = [60Hz NEMA] (60)</b> .   | According to drive rating | According to drive rating                                       |
| <b>UnS</b>              | <input type="checkbox"/> <b>[Rated motor volt.]</b><br><br>Rated motor voltage given on the nameplate.<br>ATV71●●●M3: 100 to 240 V<br>ATV71●●●N4: 200 to 480 V  | According to drive rating | According to drive rating and <b>[Standard mot. freq] (bFr)</b> |
| <b>nCr</b>              | <input type="checkbox"/> <b>[Rated mot. current]</b><br><br>Rated motor current given on the nameplate.   | 0.25 to 1.5 In (1)        | According to drive rating and <b>[Standard mot. freq] (bFr)</b> |
| <b>FrS</b>              | <input type="checkbox"/> <b>[Rated motor freq.]</b><br><br>Rated motor frequency given on the nameplate.<br>The factory setting is 50 Hz, or preset to 60 Hz if <b>[Standard mot. freq] (bFr)</b> is set to 60 Hz.  | 10 to 500 Hz              | 50 Hz   |
| <b>nSP</b>              | <input type="checkbox"/> <b>[Rated motor speed]</b><br><br>Rated motor speed given on the nameplate.<br>0 to 9999 rpm then 10.00 to 60.00 krpm on the integrated display terminal.<br>If, rather than the rated speed, the nameplate indicates the synchronous speed and the slip in Hz or as a %, calculate the rated speed as follows: <ul style="list-style-type: none"> <li>• Nominal speed = Synchronous speed x <math>\frac{100 - \text{slip as a \%}}{100}</math></li> <li>or</li> <li>• Nominal speed = Synchronous speed x <math>\frac{50 - \text{slip in Hz}}{50}</math> (50 Hz motors)</li> <li>or</li> <li>• Nominal speed = Synchronous speed x <math>\frac{60 - \text{slip in Hz}}{60}</math> (60 Hz motors)</li> </ul> | 0 to 60000 RPM            | According to drive rating                                       |
| <b>tFr</b>              | <input type="checkbox"/> <b>[Max frequency]</b><br><br>The factory setting is 60 Hz, or preset to 72 Hz if <b>[Standard mot. freq] (bFr)</b> is set to 60 Hz.<br>The maximum value is limited by the following conditions: <ul style="list-style-type: none"> <li>• It must not exceed 10 times the value of <b>[Rated motor freq.] (FrS)</b></li> <li>• It must not exceed 500 Hz if the drive rating is higher than ATV71HD37 (values between 500 Hz and 1600 Hz are only possible for powers limited to 37 kW (50 HP).</li> </ul>  | 10 to 1600 Hz             | 60 Hz   |

(1) In corresponds to the rated drive current indicated in the Installation Manual and on the drive nameplate.



## [1.1 SIMPLY START] (SIM-)

| Code                                       | Name/Description  | Factory setting  |
|--|---|------------------|
| tUn<br>nO<br>YES<br>dOnE                   | <input type="checkbox"/> <b>[Auto tuning]</b><br><input type="checkbox"/> <b>[No]</b> (nO): Auto-tuning not performed.<br><input type="checkbox"/> <b>[Yes]</b> (YES): Auto-tuning is performed as soon as possible, then the parameter automatically changes to <b>[Done]</b> (dOnE).<br><input type="checkbox"/> <b>[Done]</b> (dOnE): Use of the values given the last time auto-tuning was performed.<br><b>Caution:</b> <ul style="list-style-type: none"> <li>It is essential that all motor parameters ([Rated motor volt.] (UnS), [Rated motor freq.] (FrS), [Rated mot. current] (nCr), [Rated motor speed] (nSP), [Rated motor power] (nPr)) are configured correctly before starting auto-tuning.<br/>If at least one of these parameters is modified after auto-tuning has been performed, <b>[Auto tuning]</b> (tUn) will return to <b>[No]</b> (nO) and must be repeated.</li> <li>Auto-tuning is only performed if no stop command has been activated. If a "freewheel stop" or "fast stop" function has been assigned to a logic input, this input must be set to 1 (active at 0).</li> <li>Auto-tuning takes priority over any run or prefluxing commands, which will be taken into account after the auto-tuning sequence.</li> <li>If auto-tuning fails, the drive displays <b>[No]</b> (nO) and, depending on the configuration of <b>[Autotune fault mgt]</b> (tnL) page 231, may switch to <b>[Auto-tuning]</b> (tnF) fault mode.</li> <li>Auto-tuning may last for 1 to 2 seconds. Do not interrupt the process. Wait for the display to change to "[Done] (dOnE)" or "[No] (nO)".</li> </ul>  <b>Note:</b> During auto-tuning the motor operates at rated current. | [No] (nO)        |
| tUS<br>tAb<br>PEnd<br>PrOG<br>FAIL<br>dOnE | <input type="checkbox"/> <b>[Auto tuning status]</b><br>(for information only, cannot be modified)<br><input type="checkbox"/> <b>[Not done]</b> (tAb): The default stator resistance value is used to control the motor.<br><input type="checkbox"/> <b>[Pending]</b> (PEnd): Auto-tuning has been requested but not yet performed.<br><input type="checkbox"/> <b>[In Progress]</b> (PrOG): Auto-tuning in progress.<br><input type="checkbox"/> <b>[Failed]</b> (FAIL): Auto-tuning has failed.<br><input type="checkbox"/> <b>[Done]</b> (dOnE): The stator resistance measured by the auto-tuning function is used to control the motor.   | [Not done] (tAb) |
| PHr<br>AbC<br>ACb                          | <input type="checkbox"/> <b>[Output Ph rotation]</b><br><input type="checkbox"/> <b>[ABC]</b> (AbC): Forward<br><input type="checkbox"/> <b>[ACB]</b> (ACb): Reverse<br>This parameter can be used to reverse the direction of rotation of the motor without reversing the wiring.  | [ABC] (AbC)      |

## [1.1 SIMPLY START] (SIM-)

### Parameters that can be changed during operation or when stopped

| Code         | Name/Description   | Factory setting                                |
|--------------|--|--|
| <i>I E H</i> | <input type="checkbox"/> <b>[Mot. therm. current]</b><br>Motor thermal protection current, to be set to the rated current indicated on the nameplate.  | 0.2 to 1.5 In (1)<br>According to drive rating |
| <i>A C C</i> | <input type="checkbox"/> <b>[Acceleration]</b><br>Time to accelerate from 0 to the [Rated motor freq.] (FrS) (page 40). Make sure that this value is compatible with the inertia being driven.   | 0.1 to 999.9 s<br>3.0 s                        |
| <i>d E C</i> | <input type="checkbox"/> <b>[Deceleration]</b><br>Time to decelerate from the [Rated motor freq.] (FrS) (page 40) to 0. Make sure that this value is compatible with the inertia being driven.   | 0.1 to 999.9 s<br>3.0 s                        |
| <i>L S P</i> | <input type="checkbox"/> <b>[Low speed]</b><br>Motor frequency at minimum reference, can be set between 0 and [High speed] (HSP).  | 0  |
| <i>H S P</i> | <input type="checkbox"/> <b>[High speed]</b><br>Motor frequency at maximum reference, can be set between [Low speed] (LSP) and [Max frequency] (tFr). The factory setting changes to 60 Hz if [Standard mot. freq] (bFr) = [60Hz NEMA] (60). | 50 Hz  |

(1) In corresponds to the rated drive current indicated in the Installation Manual and on the drive nameplate.

## [1.2 MONITORING] (SUP-)

With graphic display terminal:

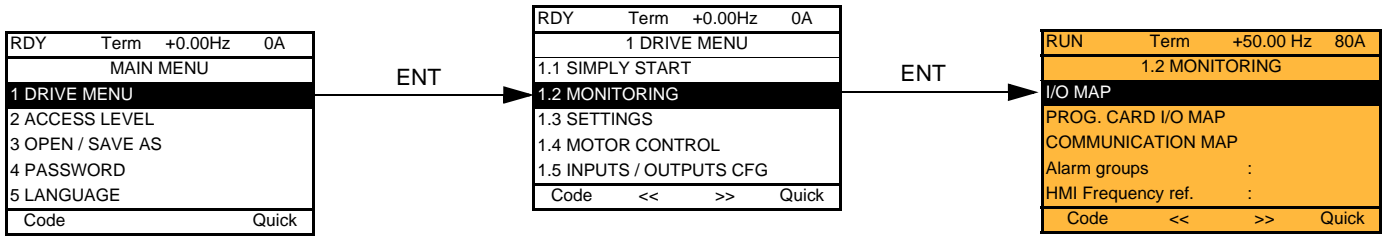

With integrated display terminal:

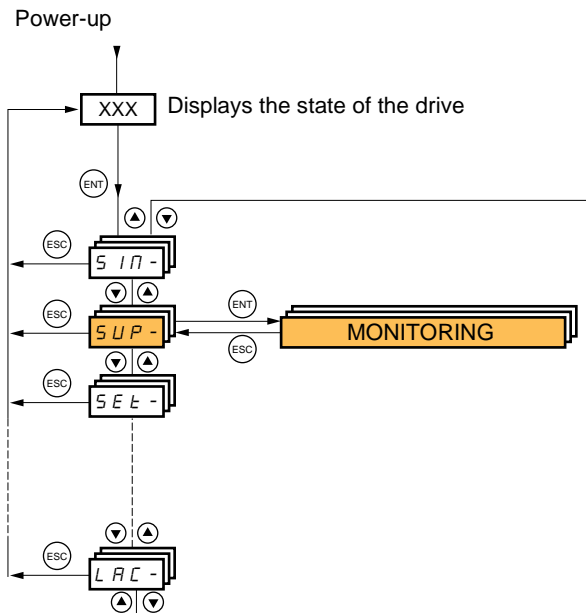

## With graphic display terminal

This menu can be used to display the inputs/outputs, the drive internal states and values, and the communication data and values.

|                     |      |          |       |
|---------------------|------|----------|-------|
| RUN                 | Term | +50.00Hz | 80A   |
| 1.2 MONITORING      |      |          |       |
| I/O MAP             |      |          |       |
| PROG. CARD I/O MAP  |      |          |       |
| COMMUNICATION MAP   |      |          |       |
| Alarm groups:       |      |          |       |
| HMI Frequency ref.: |      |          |       |
| Code                | <<   | >>       | Quick |

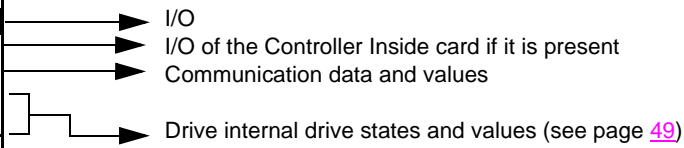

### I/O

|                      |      |          |       |
|----------------------|------|----------|-------|
| RUN                  | Term | +50.00Hz | 80A   |
| I/O MAP              |      |          |       |
| LOGIC INPUT MAP      |      |          |       |
| ANALOG INPUTS IMAGE  |      |          |       |
| LOGIC OUTPUT MAP     |      |          |       |
| ANALOG OUTPUTS IMAGE |      |          |       |
| FREQ. SIGNAL IMAGE   |      |          |       |
| Code                 | <<   | >>       | Quick |

Move from one screen to another (from LOGIC INPUT MAP to FREQ. SIGNAL IMAGE) by turning the navigation button

- State 0
- State 1

|                 |      |          |       |
|-----------------|------|----------|-------|
| RUN             | Term | +50.00Hz | 80A   |
| LOGIC INPUT MAP |      |          |       |
| PR              | LI1  | LI2      | LI3   |
| LI4             | LI5  | LI6      | LI7   |
| LI8             | LI9  | LI10     | LI11  |
| LI12            | LI13 | LI14     |       |
| Code            | <<   | >>       | Quick |

Access to the selected input or output configuration: Press ENT.

|                |      |          |       |
|----------------|------|----------|-------|
| RUN            | Term | +50.00Hz | 80A   |
| LI1 assignment |      |          |       |
| Forward        |      |          |       |
| Pre Fluxing    |      |          |       |
| LI1 On Delay   | :    |          | 0 ms  |
| Code           | <<   | >>       | Quick |

|                     |      |          |         |
|---------------------|------|----------|---------|
| RUN                 | Term | +50.00Hz | 80A     |
| ANALOG INPUTS IMAGE |      |          |         |
| AI1                 | :    |          | 9.87 V  |
| AI2                 | :    |          | 2.35 mA |
| Code                | <<   | >>       | Quick   |

ENT

|                  |      |          |        |
|------------------|------|----------|--------|
| RUN              | Term | +50.00Hz | 80A    |
| AI1 assignment   |      |          |        |
| Ref.1 channel    |      |          |        |
| Forced local     |      |          |        |
| Torque reference |      |          |        |
| AI1 min value    | :    |          | 0.0 V  |
| AI1 max value    | :    |          | 10.0 V |
| Code             | <<   | >>       | Quick  |

- State 0
- State 1

|                  |                  |          |       |
|------------------|------------------|----------|-------|
| RUN              | Term             | +50.00Hz | 80A   |
| LOGIC OUTPUT MAP |                  |          |       |
| R1               | R2               | LO       |       |
| LOA:             | 000000000000010b |          |       |
| Code             | <<               | >>       | Quick |

ENT

|                  |      |          |       |
|------------------|------|----------|-------|
| RUN              | Term | +50.00Hz | 80A   |
| LO1 assignment   |      |          |       |
| No               |      |          |       |
| LO1 delay time   | :    |          | 0 ms  |
| LO1 active at    | :    |          | 1     |
| LO1 holding time | :    |          | 0 ms  |
| Code             | <<   | >>       | Quick |

|                      |      |          |        |
|----------------------|------|----------|--------|
| RUN                  | Term | +50.00Hz | 80A    |
| ANALOG OUTPUTS IMAGE |      |          |        |
| AO1                  | :    |          | 9.87 V |
| Code                 | <<   | >>       | Quick  |

ENT

|                |      |          |       |
|----------------|------|----------|-------|
| RUN            | Term | +50.00Hz | 80A   |
| AO1 assignment |      |          |       |
| Motor freq.    |      |          |       |
| AO1 min output | :    |          | 4 mA  |
| AO1 max output | :    |          | 20 mA |
| AO1 Filter     | :    |          | 10 ms |
| Code           | <<   | >>       | Quick |

|                    |      |          |           |
|--------------------|------|----------|-----------|
| RUN                | Term | +50.00Hz | 80A       |
| FREQ. SIGNAL IMAGE |      |          |           |
| RP input           | :    |          | 25.45 kHz |
| Encoder            | :    |          | 225 kHz   |
| Code               | <<   | >>       | Quick     |

ENT

|                |      |          |        |
|----------------|------|----------|--------|
| RUN            | Term | +50.00Hz | 80A    |
| RP assignment  |      |          |        |
| Frequency ref. |      |          |        |
| RP min value   | :    |          | 2 kHz  |
| RP max value   | :    |          | 50 kHz |
| RP filter      | :    |          | 0 ms   |
| Code           | <<   | >>       | Quick  |

With graphic display terminal

Controller Inside card I/O

|                    |       |          |     |
|--------------------|-------|----------|-----|
| RUN                | Term  | +50.00Hz | 80A |
| PROG. CARD I/O MAP |       |          |     |
| PROG CARD LI MAP   |       |          |     |
| PROG. CARD AI MAP  |       |          |     |
| PROG CARD LO MAP   |       |          |     |
| PROG. CARD AO MAP  |       |          |     |
| Code               | Quick |          |     |

Move from one screen to another  
(from PROG CARD LI MAP  
to PROG. CARD AO MAP)  
by turning the navigation button

- State 0
- State 1

|                  |      |          |      |
|------------------|------|----------|------|
| RUN              | Term | +50.00Hz | 80A  |
| PROG CARD LI MAP |      |          |      |
| 1                | LI51 | LI52     | LI53 |
| 0                | LI54 | LI55     | LI56 |
|                  | LI57 | LI58     |      |
| 1                | LI59 | LI60     |      |
| 0                |      |          |      |
| << >> Quick      |      |          |      |

|                  |      |          |       |
|------------------|------|----------|-------|
| RUN              | Term | +50.00Hz | 80A   |
| PROG CARD AI MAP |      |          |       |
| AI51             | :    | 0.000 mA |       |
| AI52             | :    | 9.87 V   |       |
| Code             | <<   | >>       | Quick |

ENT

|             |      |              |     |
|-------------|------|--------------|-----|
| RUN         | Term | +50.00Hz     | 80A |
| AI51        |      |              |     |
| 0 mA        |      |              |     |
| Min = 0.001 |      | Max = 20,000 |     |
| << >> Quick |      |              |     |

- State 0
- State 1

|                  |      |          |      |
|------------------|------|----------|------|
| RUN              | Term | +50.00Hz | 80A  |
| PROG CARD LO MAP |      |          |      |
| 1                | LO51 | LO52     | LO53 |
| 0                | LO54 | LO55     | LO56 |
| << >> Quick      |      |          |      |

|                   |      |          |       |
|-------------------|------|----------|-------|
| RUN               | Term | +50.00Hz | 80A   |
| PROG. CARD AO MAP |      |          |       |
| AO51              | :    | 0.000 mA |       |
| AO52              | :    | 9.87 V   |       |
| Code              | <<   | >>       | Quick |

ENT

|             |      |              |     |
|-------------|------|--------------|-----|
| RUN         | Term | +50.00Hz     | 80A |
| AO51        |      |              |     |
| 0 mA        |      |              |     |
| Min = 0.001 |      | Max = 20,000 |     |
| << >> Quick |      |              |     |

## With graphic display terminal

### Communication

| RUN                  | Term     | +50.00Hz | 80A |
|----------------------|----------|----------|-----|
| COMMUNICATION MAP    |          |          |     |
| Command Channel :    | Modbus   |          |     |
| Cmd value :          | ABCD Hex |          |     |
| Active ref. channel: | CANopen  |          |     |
| Frequency ref. :     | -12.5 Hz |          |     |
| ETA state word:      | 2153 Hex |          |     |
| Code                 | Quick    |          |     |

W3141 : F230 Hex  
 W2050 : F230 Hex  
 W4325 : F230 Hex  
 W0894 : F230 Hex

COM. SCANNER INPUT MAP  
 COM SCAN OUTPUT MAP  
 CMD. WORD IMAGE  
 FREQ. REF. WORD MAP  
 MODBUS NETWORK DIAG  
 MODBUS HMI DIAG  
 CANopen MAP  
 PROG. CARD SCANNER

[COMMUNICATION MAP] indicates the types of bus used for control or reference, the corresponding command and reference values, the status word, the words selected in the [DISPLAY CONFIG.] menu, etc.

The display format (hexadecimal or decimal) can be configured in the [DISPLAY CONFIG.] menu.

| RUN                    | Term  | +50.00Hz | 80A |
|------------------------|-------|----------|-----|
| COM. SCANNER INPUT MAP |       |          |     |
| Com Scan In1 val.:     | 0     |          |     |
| Com Scan In2 val.:     | 0     |          |     |
| Com Scan In3 val.:     | 0     |          |     |
| Com Scan In4 val.:     | 0     |          |     |
| Com Scan In5 val.:     | 0     |          |     |
| Code                   | Quick |          |     |
| Com Scan In6 val.:     | 0     |          |     |
| Com Scan In7 val.:     | 0     |          |     |
| Com Scan In8 val.:     | 0     |          |     |

| RUN                 | Term  | +50.00Hz | 80A |
|---------------------|-------|----------|-----|
| COM SCAN OUTPUT MAP |       |          |     |
| Com Scan Out1 val.: | 0     |          |     |
| Com Scan Out2 val.: | 0     |          |     |
| Com Scan Out3 val.: | 0     |          |     |
| Com Scan Out4 val.: | 0     |          |     |
| Com Scan Out5 val.: | 0     |          |     |
| Code                | Quick |          |     |
| Com Scan Out6 val.: | 0     |          |     |
| Com Scan Out7 val.: | 0     |          |     |
| Com Scan Out8 val.: | 0     |          |     |

| RUN              | Term      | +50.00Hz | 80A |
|------------------|-----------|----------|-----|
| CMD. WORD IMAGE  |           |          |     |
| Modbus cmd.:     | 0000 Hex. |          |     |
| CANopen cmd.:    | 0000 Hex. |          |     |
| COM. card cmd.:  | 0000 Hex. |          |     |
| Prog. card cmd.: | 0000 Hex. |          |     |
| Code             | Quick     |          |     |

| RUN                 | Term   | +50.00Hz | 80A |
|---------------------|--------|----------|-----|
| FREQ. REF. WORD MAP |        |          |     |
| Ref. Modbus:        | 0.0 Hz |          |     |
| Ref. CANopen:       | 0.0 Hz |          |     |
| Com. card ref.:     | 0.0 Hz |          |     |
| Prog. Card ref.:    | 0.0 Hz |          |     |
| Code                | Quick  |          |     |

[COM. SCANNER INPUT MAP] and [COM SCAN OUTPUT MAP]:

Visualization of registers exchanged periodically (8 input and 8 output) for integrated Modbus and for fieldbus cards.

## With graphic display terminal

### Communication (continued)

The state of the LEDs, the periodic data, the address, the speed, and the format, etc., is given for each bus.

| RUN                  | Term     | +50.00Hz | 80A |
|----------------------|----------|----------|-----|
| COMMUNICATION MAP    |          |          |     |
| Command Channel :    | Modbus   |          |     |
| Cmd value :          | ABCD Hex |          |     |
| Active ref. channel: | CANopen  |          |     |
| Frequency ref. :     | -12.5 Hz |          |     |
| ETA state word:      | 2153 Hex |          |     |
| Code                 | Quick    |          |     |

- W3141 : F230 Hex
- W2050 : F230 Hex
- W4325 : F230 Hex
- W0894 : F230 Hex
- COM. SCANNER INPUT MAP
- COM SCAN OUTPUT MAP
- CMD. WORD IMAGE
- FREQ. REF. WORD MAP
- MODBUS NETWORK DIAG
- MODBUS HMI DIAG
- CANopen MAP
- PROG. CARD SCANNER

- ⊗ LED off
- ⊙ LED on

#### Communication via Modbus

| RUN                 | Term  | +50.00Hz | 80A |
|---------------------|-------|----------|-----|
| MODBUS NETWORK DIAG |       |          |     |
| COM LED :           | ⊗     |          |     |
| Mb NET frames nb.   |       |          |     |
| Mb NET CRC errors   |       |          |     |
| Code                | Quick |          |     |

#### Communication via the graphic display terminal

| RUN               | Term  | +50.00Hz | 80A |
|-------------------|-------|----------|-----|
| MODBUS HMI DIAG   |       |          |     |
| COM LED :         | ⊙     |          |     |
| Mb HMI frames nb. |       |          |     |
| Mb HMI CRC errors |       |          |     |
| Code              | Quick |          |     |

#### Communication via CANopen

| RUN         | Term  | +50.00Hz | 80A |
|-------------|-------|----------|-----|
| CANopen MAP |       |          |     |
| RUN LED:    | ⊗     |          |     |
| ERR LED:    | ⊗     |          |     |
| PDO1 IMAGE  |       |          |     |
| PDO2 IMAGE  |       |          |     |
| PDO3 IMAGE  |       |          |     |
| Code        | Quick |          |     |

|                   |   |
|-------------------|---|
| Canopen NMT state |   |
| Number of TX PDO  | 0 |
| Number of RX PDO  | 0 |
| Error code        | 0 |
| RX Error Counter  | 0 |
| TX Error Counter  | 0 |

PDO images are only visible if CANopen has been enabled (address other than OFF) and if the PDOs are active.

PDO configuration using the network tool. Some PDOs cannot be used.

| RUN               | Term     | +50.00Hz | 80A |
|-------------------|----------|----------|-----|
| PDO1 IMAGE        |          |          |     |
| Received PDO1-1 : | FDBA Hex |          |     |
| Received PDO1-2   |          |          |     |
| Received PDO1-3   |          |          |     |
| Received PDO1-4   |          |          |     |
| Transmit PDO1-1 : | FDBA Hex |          |     |
| Code              | Quick    |          |     |

|                 |  |
|-----------------|--|
| Transmit PDO1-2 |  |
| Transmit PDO1-3 |  |
| Transmit PDO1-4 |  |

| RUN               | Term     | +50.00Hz | 80A |
|-------------------|----------|----------|-----|
| PDO2 IMAGE        |          |          |     |
| Received PDO2-1 : | FDBA Hex |          |     |
| Received PDO2-2   |          |          |     |
| Received PDO2-3   |          |          |     |
| Received PDO2-4   |          |          |     |
| Transmit PDO2-1 : | FDBA Hex |          |     |
| Code              | Quick    |          |     |

|                 |  |
|-----------------|--|
| Transmit PDO2-2 |  |
| Transmit PDO2-3 |  |
| Transmit PDO2-4 |  |

| RUN               | Term     | +50.00Hz | 80A |
|-------------------|----------|----------|-----|
| PDO3 IMAGE        |          |          |     |
| Received PDO3-1 : | FDBA Hex |          |     |
| Received PDO3-2   |          |          |     |
| Received PDO3-3   |          |          |     |
| Received PDO3-4   |          |          |     |
| Transmit PDO3-1 : | FDBA Hex |          |     |
| Code              | Quick    |          |     |

|                 |  |
|-----------------|--|
| Transmit PDO3-2 |  |
| Transmit PDO3-3 |  |
| Transmit PDO3-4 |  |

## With graphic display terminal

### Communication (continued)

| RUN                  | Term     | +50.00Hz | 80A |
|----------------------|----------|----------|-----|
| COMMUNICATION MAP    |          |          |     |
| Command Channel :    | Modbus   |          |     |
| Cmd value :          | ABCD Hex |          |     |
| Active ref. channel: | CANopen  |          |     |
| Frequency ref. :     | -12.5 Hz |          |     |
| ETA state word:      | 2153 Hex |          |     |
| Code                 | Quick    |          |     |

W3141 : F230 Hex  
 W2050 : F230 Hex  
 W4325 : F230 Hex  
 W0894 : F230 Hex  
 COM. SCANNER INPUT MAP  
 COM SCAN OUTPUT MAP  
 CMD. WORD IMAGE  
 FREQ. REF. WORD MAP  
 MODBUS NETWORK DIAG  
 MODBUS HMI DIAG  
 CANopen MAP  
 PROG. CARD SCANNER

#### Controller Inside card

| RUN                | Term  | +50.00Hz | 80A |
|--------------------|-------|----------|-----|
| PROG. CARD SCANNER |       |          |     |
| Input scanner      |       |          |     |
| Output scanner     |       |          |     |
| Code               | Quick |          |     |

| RUN                 | Term  | +50.00Hz | 80A |
|---------------------|-------|----------|-----|
| Input scanner       |       |          |     |
| Prg.card. scan in1: | 0     |          |     |
| Prg.card. scan in2: | 0     |          |     |
| Prg.card. scan in3: | 0     |          |     |
| Prg.card. scan in4: | 0     |          |     |
| Prg.card. scan in5: | 0     |          |     |
| Code                | Quick |          |     |

|                    |   |  |  |
|--------------------|---|--|--|
| Prg.card scan in6: | 0 |  |  |
| Prg.card scan in7: | 0 |  |  |
| Prg.card scan in8: | 0 |  |  |

| RUN                  | Term  | +50.00Hz | 80A |
|----------------------|-------|----------|-----|
| Output scanner       |       |          |     |
| PLC card.scan Out1:  | 0     |          |     |
| PLC card.scan Out2:  | 0     |          |     |
| PLC card.scan Out3:  | 0     |          |     |
| PLC card.scan Out4:  | 0     |          |     |
| PLC card.scan Out5 : | 0     |          |     |
| Code                 | Quick |          |     |

|                     |   |  |  |
|---------------------|---|--|--|
| PLC card.scan Out6: | 0 |  |  |
| PLC card.scan Out7: | 0 |  |  |
| PLC card.scan Out8: | 0 |  |  |

[Input scanner] and [Output scanner]:

Visualization of registers exchanged periodically (8 input and 8 output).



## [1.2 MONITORING] (SUP-)

### With graphic display terminal: Drive-internal states and values

| Name/Description              |   |
|-------------------------------|---|
| [Alarm groups] (ALGr)         | Current alarm group numbers   |
| [HMI Frequency ref.] (LFr)    | in Hz. Frequency reference via the graphic display terminal (can be accessed if the function has been configured).  |
| [Internal PID ref.] (rPI)     | as a process value. PID reference via graphic display terminal (can be accessed if the function has been configured).   |
| [HMI torque ref.] (Ltr)       | as a % of the rated torque. Torque reference via graphic display terminal.  |
| [Multiplying coeff.] (MFr)    | as a % (can be accessed if [Multiplier ref. -] (MA2,MA3) page 133 has been assigned)  |
| [Frequency ref.] (FrH)        | in Hz   |
| [Torque reference] (trr)      | as a % of the rated torque (can be accessed if the function has been configured)  |
| [Output frequency] (rFr)      | in Hz   |
| [Measured output fr.] (MMF)   | in Hz: The measured motor speed is displayed if an encoder card has been inserted and configured in speed feedback mode, otherwise 0 appears.   |
| [Pulse in. work. freq.] (FqS) | in Hz: Frequency of the "Pulse input" input used by the [FREQUENCY METER] (FqF-) function, page 228.  |
| [Motor current] (LCr)         | in A  |
| [ENA avg speed] (AUS)         | in Hz: The parameter can be accessed if [ENA system] (EnA) = [Yes] (YES) (see page 78)  |
| [Motor speed] (SPd)           | in rpm  |
| [Motor voltage] (UOP)         | in V  |
| [Motor power] (OPr)           | as a % of the rated power   |
| [Motor torque] (Otr)          | as a % of the rated torque  |
| [Mains voltage] (ULn)         | in V. Line voltage from the point of view of the DC bus, motor running or stopped.  |
| [Motor thermal state] (tHr)   | as a %  |
| [Drv.thermal state] (tHd)     | as a %  |
| [DBR thermal state] (tHb)     | as a % (can only be accessed on high rating drives)   |
| [Consumption] (APH)           | in Wh, kWh or MWh (accumulated consumption)   |
| [Run time] (rtH)              | in seconds, minutes or hours (length of time the motor has been switched on)  |
| [Power on time] (PtH)         | in seconds, minutes or hours (length of time the drive has been switched on)  |
| [IGBT alarm counter] (tAC)    | in seconds (length of time the "IGBT temperature" alarm has been active)  |
| [PID reference] (rPC)         | as a process value (can be accessed if the PID function has been configured)  |
| [PID feedback] (rPF)          | as a process value (can be accessed if the PID function has been configured)  |
| [PID error] (rPE)             | as a process value (can be accessed if the PID function has been configured)  |
| [PID Output] (rPO)            | in Hz (can be accessed if the PID function has been configured)   |
| [Date/Time] (CLO)             | Current date and time generated by the Controller Inside card (can be accessed if the card has been inserted)   |
| [- - - -] (o02)               | Words generated by the Controller Inside card (can be accessed if the card has been inserted)   |
| to                            |   |
| [- - - -] (o06)               |   |
| [Config. active] (CnFS)       | Active configuration [Config. n°0, 1 or 2]  |
| [Utilised param. set] (CFPS)  | [Set n°1, 2 or 3] (can be accessed if parameter switching has been enabled, see page 195)   |
| [ALARMS] (ALr-)               | List of current alarms. If an alarm is present, a ✓ appears.  |
| [OTHER STATE] (SSt-)          | List of secondary states: <ul style="list-style-type: none"> <li>- [In motor fluxing] (FLX): In motor fluxing</li> <li>- [PTC1 alarm] (PtC1): Probe alarm 1</li> <li>- [PTC2 alarm] (PtC2): Probe alarm 2</li> <li>- [LI6=PTC alarm] (PtC3): LI6 = PTC probe alarm</li> <li>- [Fast stop in prog.] (FSt): Fast stop in progress</li> <li>- [Current Th. attained] (CtA): Current threshold attained ([Current threshold] (Ctd) page 64)</li> <li>- [Freq. Th. attained] (FtA): Frequency threshold attained ([Freq. threshold] (Ftd) page 65)</li> <li>- [Freq. Th. 2 attained] (F2A): 2<sup>nd</sup> frequency threshold attained ([Freq. threshold 2] (F2d) page 65)</li> <li>- [Frequency ref. att.] (SrA): Frequency reference attained</li> <li>- [Motor th. state att.] (tSA): Motor 1 thermal state attained</li> <li>- [External fault alarm] (EtF): External fault alarm</li> <li>- [Auto restart] (AUtO): Automatic restart in progress</li> <li>- [Remote] (FtL) : Line mode control</li> <li>- [Auto-tuning] (tUn): Performing auto-tuning</li> <li>- [Undervoltage] (USA): Undervoltage alarm</li> <li>- [Cnfg.1 act.] (CnF1): Configuration 1 active</li> <li>- [Cnfg.2 act.] (CnF2): Configuration 2 active</li> <li>- [HSP attained] (FLA): High speed attained</li> <li>- [Load slipping] (AnA): Slipping alarm</li> <li>- [Set 1 active] (CFP1): Parameter set 1 active</li> <li>- [Set 2 active] (CFP2): Parameter set 2 active</li> <li>- [Set 3 active] (CFP3): Parameter set 3 active</li> <li>- [In braking] (brS): Drive braking</li> <li>- [DC bus loading] (dbL): DC bus loading</li> <li>- [Forward] (MFrd): Motor running forward</li> <li>- [Reverse] (MrrS): Motor running in reverse</li> <li>- [High torque alarm] (ttHA): Motor torque overshooting high threshold [High torque thd.] (tH) page 64.</li> <li>- [Low torque alarm] (ttLA): Motor torque undershooting low threshold [Low torque thd.] (ttL) page 64.</li> <li>- [Freq. meter Alarm] (FqLA): Measured speed threshold attained: [Pulse warning thd.] (FqL) page 65.</li> </ul> |

## [1.2 MONITORING] (SUP-)

### With integrated display terminal

This menu can be used to display the drive inputs, states and internal values.

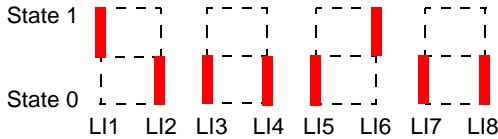
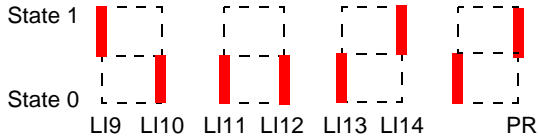
| Code   | Name/Description  | Adjustment range | Factory setting |
|--|---|------------------|-----------------|
| <b>I 0 7 -</b>   | <b>I/O MAP</b>  |                  |                 |
| <b>L 1 A -</b>   | <b>Logic input functions</b>  |                  |                 |
| <b>L 1 A</b><br>to<br><b>L 1 4 A</b>                                 | <p>Can be used to display the functions assigned to each input. If no functions have been assigned, nO is displayed.</p> <p>Use the ▲ and ▼ arrows to scroll through the functions. If a number of functions have been assigned to the same input, check that they are compatible.</p>  |                  |                 |
| <b>L 1 5 1</b>   | <b>State of logic inputs LI1 to LI8</b>   |                  |                 |
|  | <p>Can be used to visualize the state of logic inputs LI1 to LI8 (display segment assignment: high = 1, low = 0)</p>  <p>Example above: LI1 and LI6 are at 1; LI2 to LI5, LI7 and LI8 are at 0.</p>  |                  |                 |
| <b>L 1 5 2</b>   | <b>State of logic inputs LI9 to LI14 and Power Removal</b>  |                  |                 |
|  | <p>Can be used to visualize the state of logic inputs LI9 to LI14 and PR (Power Removal) (display segment assignment: high = 1, low = 0)</p>  <p>Example above: LI9 and LI14 are at 1, LI10 to LI13 are at 0 and PR (Power Removal) is at 1.</p> |                  |                 |
| <b>A 1 A -</b>   | <b>Analog input functions</b>   |                  |                 |
| <b>A 1 1 A</b><br><b>A 1 2 A</b><br><b>A 1 3 A</b><br><b>A 1 4 A</b> | <p>Can be used to display the functions assigned to each input. If no functions have been assigned, nO is displayed. Use the ▲ and ▼ arrows to scroll through the functions. If a number of functions have been assigned to the same input, check that they are compatible.</p>   |                  |                 |

## [1.2 MONITORING] (SUP-)

### With integrated display terminal: Drive-internal states and values

| Code           | Name/Description  | Unit                            |
|----------------|---|---------------------------------|
| <b>ALGr</b>    | <b>Alarm groups:</b> Current alarm group numbers  |                                 |
| <b>rPI</b>     | <b>Internal PID reference:</b> PID reference via graphic display terminal (can be accessed if the function has been configured).              | as a process value              |
| <b>PFr</b>     | <b>Multiplication coefficient</b> (can be accessed if <a href="#">[Multiplier ref. -] (MA2,MA3)</a> page 133 has been assigned)               | %                               |
| <b>F r H</b>   | <b>Frequency ref.</b>   | Hz                              |
| <b>t r r</b>   | <b>Torque reference:</b> Can be accessed if the function has been configured  | %.                              |
| <b>r F r</b>   | <b>Output frequency</b>   | Hz                              |
| <b>nnF</b>     | <b>The measured motor speed is displayed</b> if an encoder card has been inserted and configured in speed feedback mode, otherwise 0 appears. | Hz                              |
| <b>F q S</b>   | <b>Frequency of the "Pulse input" input</b> used by the <a href="#">[FREQUENCY METER] (FqF-)</a> function, page 228.                          | Hz                              |
| <b>LCr</b>     | <b>Motor current</b>  | A                               |
| <b>AUS</b>     | <b>ENA avg SPEED:</b> The parameter can be accessed if EnA = YES (see page 78)  | Hz                              |
| <b>SPd</b>     | <b>Motor speed</b>  | rpm                             |
| <b>UQP</b>     | <b>Motor voltage</b>  | V                               |
| <b>OPr</b>     | <b>Motor power</b>  | %                               |
| <b>OTr</b>     | <b>Motor torque</b>   | %                               |
| <b>ULn</b>     | <b>Line voltage:</b> Line voltage from the point of view of the DC bus, motor running or stopped.   | V                               |
| <b>tHr</b>     | <b>Motor thermal state</b>  | %                               |
| <b>tHd</b>     | <b>Drv thermal state</b>  | %                               |
| <b>tHb</b>     | <b>DBR thermal state:</b> Can be accessed on high rating drives only.   | %                               |
| <b>APH</b>     | <b>Power consumption</b>  | Wh, kWh or MWh                  |
| <b>r t H</b>   | <b>Run time:</b> Length of time the motor has been turned on  | seconds,<br>minutes or<br>hours |
| <b>P t H</b>   | <b>Power on time:</b> Length of time the drive has been turned on   |                                 |
| <b>t r C</b>   | <b>IGBT alarm counter:</b> Length of time the "IGBT temperature" alarm has been active  |                                 |
| <b>r P C</b>   | <b>PID reference:</b> Can be accessed if the PID function has been configured   | as a process value              |
| <b>r P F</b>   | <b>PID feedback:</b> Can be accessed if the PID function has been configured  |                                 |
| <b>r P E</b>   | <b>PID error:</b> Can be accessed if the PID function has been configured   |                                 |
| <b>r P O</b>   | <b>PID Output:</b> Can be accessed if the PID function has been configured  |                                 |
| <b>CLD-</b>    | <b>tIME, dAY:</b> Current date and time generated by the Controller Inside card (can be accessed if the card has been inserted)               |                                 |
| <b>o02</b>     | Word generated by the Controller Inside card (can be accessed if the card has been inserted)  |                                 |
| <b>o03</b>     | Word generated by the Controller Inside card (can be accessed if the card has been inserted)  |                                 |
| <b>o04</b>     | Word generated by the Controller Inside card (can be accessed if the card has been inserted)  |                                 |
| <b>o05</b>     | Word generated by the Controller Inside card (can be accessed if the card has been inserted)  |                                 |
| <b>o06</b>     | Word generated by the Controller Inside card (can be accessed if the card has been inserted)  |                                 |
| <b>C n F S</b> | <b>Config. active:</b> CnF0, 1 or 2 (can be accessed if motor or configuration switching has been enabled, see page 199)                      |                                 |
| <b>C F P S</b> | <b>Utilised param. set:</b> CFP1, 2 or 3 (can be accessed if parameter switching has been enabled, see page 195)                              |                                 |

## [1.3 SETTINGS] (SEt-)

With graphic display terminal:

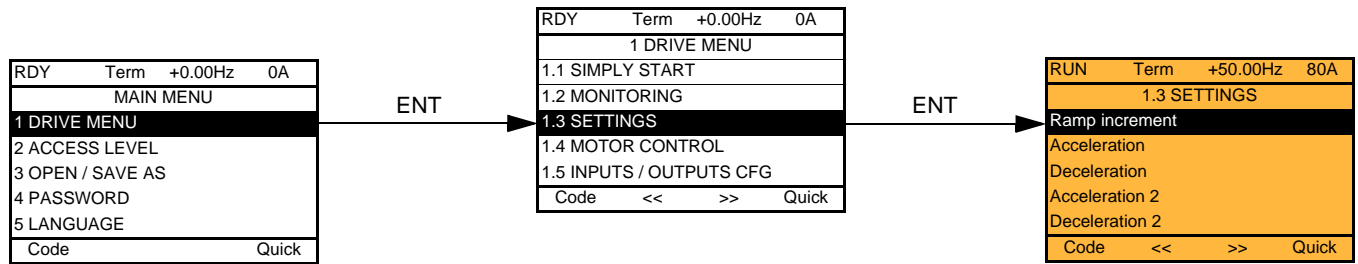

With integrated display terminal:

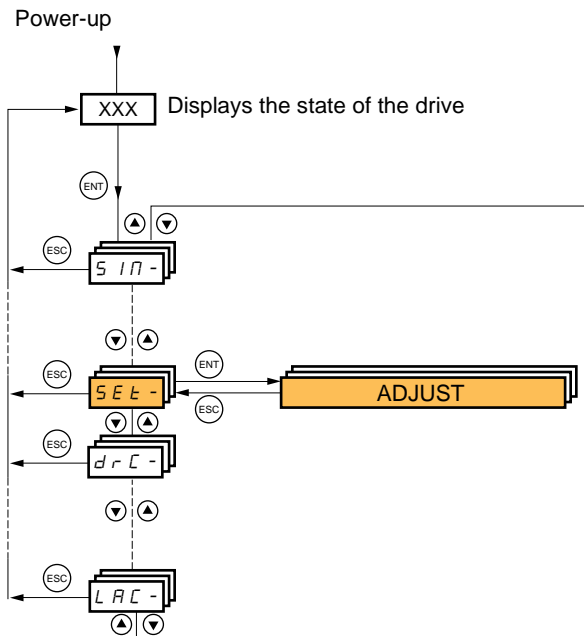

## [1.3 SETTINGS] (SEt-)

The adjustment parameters can be modified with the drive running or stopped.

|  <b>DANGER</b>   |  |
|---|--|
| <b>UNINTENDED EQUIPMENT OPERATION</b>   |  |
| <ul style="list-style-type: none"> <li>• Check that changes made to the settings during operation do not present any danger.</li> <li>• We recommend stopping the drive before making any changes.</li> </ul> |  |
| <b>Failure to follow these instructions will result in death or serious injury.</b>   |  |

| Code  | Name/Description  | Adjustment range   | Factory setting |
|---|---|--------------------|-----------------|
| <i>Inr</i><br><i>0.01</i><br><i>0.1</i><br><i>1</i> | <input type="checkbox"/> <b>[Ramp increment]</b><br><input type="checkbox"/> <b>[0,01]</b> : ramp up to 99.99 seconds<br><input type="checkbox"/> <b>[0,1]</b> : ramp up to 999.9 seconds<br><input type="checkbox"/> <b>[1]</b> : ramp up to 6000 seconds<br>This parameter is valid for <b>[Acceleration] (ACC)</b> , <b>[Deceleration] (dEC)</b> , <b>[Acceleration 2] (AC2)</b> and <b>[Deceleration 2] (dE2)</b> . | 0,01 - 0,1 - 1     | 0,1             |
| <i>ACC</i>  | <input type="checkbox"/> <b>[Acceleration]</b><br>Time to accelerate from 0 to the <b>[Rated motor freq.] (FrS)</b> (page 67). Make sure that this value is compatible with the inertia being driven.   | 0.01 to 6000 s (1) | 3.0 s           |
| <i>dEC</i>  | <input type="checkbox"/> <b>[Deceleration]</b><br>Time to decelerate from the <b>[Rated motor freq.] (FrS)</b> (page 67) to 0. Make sure that this value is compatible with the inertia being driven.   | 0.01 to 6000 s (1) | 3.0 s           |
| <i>AC2</i><br>★                                     | <input type="checkbox"/> <b>[Acceleration 2]</b><br>See page 136<br>Time to accelerate from 0 to the <b>[Rated motor freq.] (FrS)</b> . Make sure that this value is compatible with the inertia being driven.  | 0.01 to 6000 s (1) | 5.0 s           |
| <i>dE2</i><br>★                                     | <input type="checkbox"/> <b>[Deceleration 2]</b><br>See page 136<br>Time to decelerate from the <b>[Rated motor freq.] (FrS)</b> to 0. Make sure that this value is compatible with the inertia being driven.   | 0.01 to 6000 s (1) | 5.0 s           |
| <i>tA1</i><br>★                                     | <input type="checkbox"/> <b>[Begin Acc round]</b><br>See page 135<br>Rounding of start of acceleration ramp as a % of the <b>[Acceleration] (ACC)</b> or <b>[Acceleration 2] (AC2)</b> ramp time.   | 0 to 100%          | 10%             |
| <i>tA2</i><br>★                                     | <input type="checkbox"/> <b>[End Acc round]</b><br>See page 135<br>- Rounding of end of acceleration ramp as a % of the <b>[Acceleration] (ACC)</b> or <b>[Acceleration 2] (AC2)</b> ramp time.<br>- Can be set between 0 and (100% - <b>[Begin Acc round] (tA1)</b> )  |                    | 10%             |
| <i>tA3</i><br>★                                     | <input type="checkbox"/> <b>[Begin Dec round]</b><br>See page 135<br>Rounding of start of deceleration ramp as a % of the <b>[Deceleration] (dEC)</b> or <b>[Deceleration 2] (dE2)</b> ramp time.   | 0 to 100%          | 10%             |

(1) Range 0.01 to 99.99 s or 0.1 to 999.9 s or 1 to 6000 s according to **[Ramp increment] (Inr)**.

★ These parameters only appear if the corresponding function has been selected in another menu. When the parameters can also be accessed and adjusted from within the configuration menu for the corresponding function, their description is detailed in these menus, on the pages indicated, to aid programming.

## [1.3 SETTINGS] (SEt-)

| Code                | Name/Description   | Adjustment range  | Factory setting           |
|---------------------|--|-------------------|---------------------------|
| <b>EA4</b><br><br>★ | <input type="checkbox"/> <b>[End Dec round]</b><br><br>See page 135<br>- Rounding of end of deceleration ramp as a % of the [Deceleration] (dEC) or [Deceleration 2] (dE2) ramp time.<br>- Can be set between 0 and (100% - [Begin Dec round] (tA3)) |                   | 10%                       |
| <b>LSP</b>          | <input type="checkbox"/> <b>[Low speed]</b><br><br>Motor frequency at minimum reference, can be set between 0 and [High speed] (HSP).  |                   | 0 Hz                      |
| <b>HSP</b>          | <input type="checkbox"/> <b>[High speed]</b><br><br>Motor frequency at maximum reference, can be set between [Low speed] (LSP) and [Max frequency] (tFr). The factory setting changes to 60 Hz if [Standard mot. freq] (bFr) = [60Hz NEMA] (60).     |                   | 50 Hz                     |
| <b>IEH</b>          | <input type="checkbox"/> <b>[Mot. therm. current]</b><br><br>Motor thermal protection current, to be set to the rated current indicated on the nameplate.  | 0.2 to 1.5 In (1) | According to drive rating |
| <b>SPG</b>          | <input type="checkbox"/> <b>[Speed prop. gain]</b><br><br>Speed loop proportional gain   | 0 to 1000%        | 40%                       |
| <b>SIE</b>          | <input type="checkbox"/> <b>[Speed time integral]</b><br><br>Speed loop integral time constant.  | 1 to 1000%        | 100%                      |
| <b>SFC</b>          | <input type="checkbox"/> <b>[K speed loop filter]</b><br><br>Speed loop filter coefficient.  | 0 to 100          | 0                         |

(1) In corresponds to the rated drive current indicated in the Installation Manual or on the drive nameplate.

## [1.3 SETTINGS] (SEt-)

### Parameter settings for [K speed loop filter] (SFC), [Speed prop. gain] (SPG) and [Speed time integral] (SIt)

- The following parameters can only be accessed in vector control profiles: [Motor control type] (Ctt) page 69 = [SVC V] (UUC), [SVC I] (CUC), [FVC] (FUC) and [Sync. mot.] (SYn) and if [ENA system] (EnA) page 78 = [No] (nO).
- The factory settings are suitable for most applications.

#### General case: Setting for [K speed loop filter] (SFC) = 0

The regulator is an "IP" type with filtering of the speed reference, for applications requiring flexibility and stability (hoisting or high inertia, for example).

- [Speed prop. gain] (SPG) affects excessive speed.
- [Speed time integral] (SIt) affects the passband and response time.

#### Initial response

Reference division

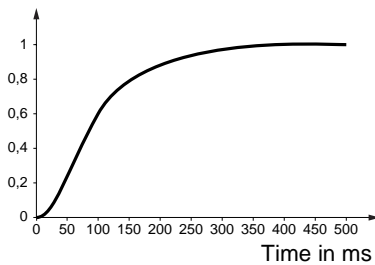

#### Reduction in SIT ↘

Reference division

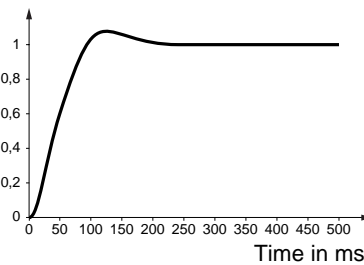

#### Reduction in SIT ↘↘

Reference division

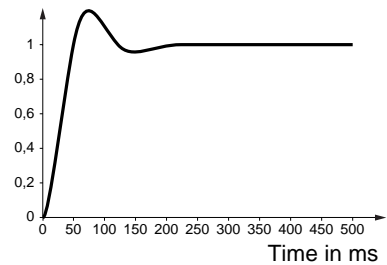

#### Initial response

Reference division

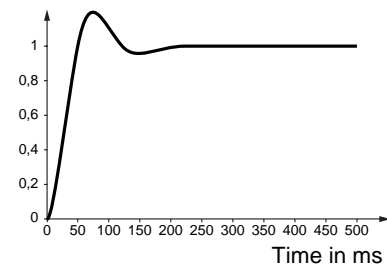

#### Increase in SPG ↗

Reference division

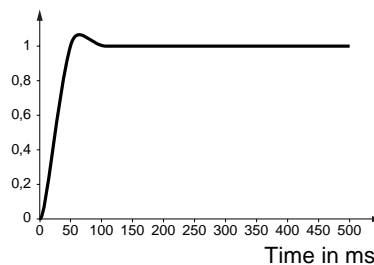

#### Increase in SPG ↗↗

Reference division

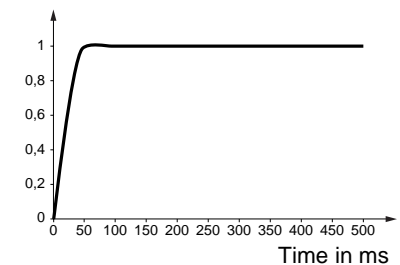

## [1.3 SETTINGS] (SEt-)

### Special case: Parameter [K speed loop filter] (SFC) not 0

This parameter must be reserved for specific applications that require a short response time (trajectory positioning or servo control).

- When set to 100 as described above the regulator is a "PI" type, without filtering of the speed reference.
- Settings between 0 and 100 will obtain an intermediate function between the settings below and those on the previous page.

### Example: Setting for [K speed loop filter] (SFC) = 100

- [Speed prop. gain] (SPG) affects the passband and response time.
- [Speed time integral] (SIt) affects excessive speed.

#### Initial response

Reference division

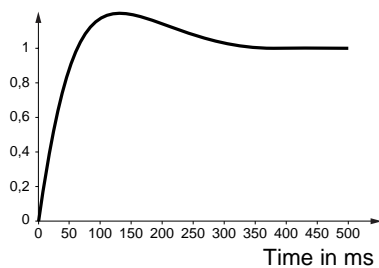

#### Reduction in SIT ↘

Reference division

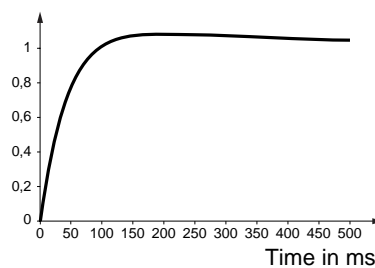

#### Reduction in SIT ↘↘

Reference division

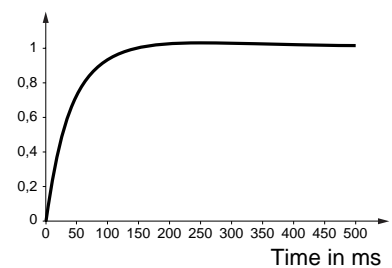

#### Initial response

Reference division

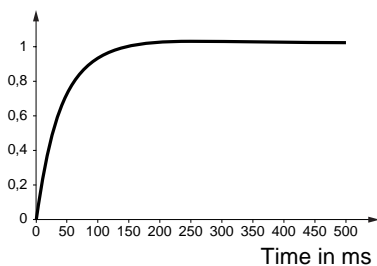

#### Increase in SPG ↗

Reference division

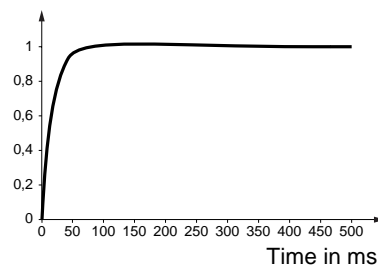

#### Increase in SPG ↗↗

Reference division

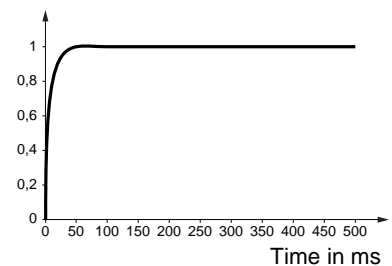



## [1.3 SETTINGS] (SEt-)

| Code             | Name/Description   | Adjustment range                         | Factory setting |
|------------------|--|--|-----------------|
| <i>GPE</i><br>★  | <input type="checkbox"/> [ENA prop.gain]<br>See page 78  | 1 to 9999                                | 250             |
| <i>GIE</i><br>★  | <input type="checkbox"/> [ENA integral gain]<br>See page 78  | 0 to 9999                                | 100             |
| <i>UF r</i><br>★ | <input type="checkbox"/> [IR compensation]<br>See page 72  | 25 to 200%                               | 100%            |
| <i>SLP</i><br>★  | <input type="checkbox"/> [Slip compensation]<br>See page 72  | 0 to 300%                                | 100%            |
| <i>dCF</i><br>★  | <input type="checkbox"/> [Ramp divider]<br>See page 137  | 0 to 10                                  | 4               |
| <i>IdC</i><br>★  | <input type="checkbox"/> [DC inject. level 1]<br>See page 138<br>Level of DC injection braking current activated via logic input or selected as stop mode.<br><br><b>CAUTION</b><br><br>Check that the motor will withstand this current without overheating.<br><b>Failure to follow this instruction can result in equipment damage.</b>   | 0.1 to 1.41 In (1)                       | 0.64 In (1)     |
| <i>td1</i><br>★  | <input type="checkbox"/> [DC injection time 1]<br>See page 138<br>Maximum current injection time [DC inject. level 1] (IdC). After this time the injection current becomes [DC inject. level 2] (IdC2).  | 0.1 to 30 s                              | 0.5 s           |
| <i>IdC2</i><br>★ | <input type="checkbox"/> [DC inject. level 2]<br>See page 138<br>Injection current activated by logic input or selected as stop mode, once period of time [DC injection time 1] (td1) has elapsed.<br><br><b>CAUTION</b><br><br>Check that the motor will withstand this current without overheating.<br><b>Failure to follow this instruction can result in equipment damage.</b> | 0.1 In (2) to [DC inject. level 1] (IdC) | 0.5 In (1)      |
| <i>tdC</i><br>★  | <input type="checkbox"/> [DC injection time 2]<br>See page 138<br>Maximum injection time [DC inject. level 2] (IdC2) for injection selected as stop mode only.   | 0.1 to 30 s                              | 0.5 s           |

(1) In corresponds to the rated drive current indicated in the Installation Manual or on the drive nameplate.

★ These parameters only appear if the corresponding function has been selected in another menu. When the parameters can also be accessed and adjusted from within the configuration menu for the corresponding function, their description is detailed in these menus, on the pages indicated, to aid programming.

# [1.3 SETTINGS] (SEt-)

| Code         | Name/Description   | Adjustment range | Factory setting |
|--------------|--|------------------|-----------------|
| SdC1<br>★    | <input type="checkbox"/> <b>[Auto DC inj. level 1]</b><br><br>Level of standstill DC injection current. This parameter can be accessed if [Auto DC injection] (AdC) page 139 is not [No] (nO)<br>This parameter is forced to 0 if [Motor control type] (Ctt) page 69 = [Sync. mot.] (SYn).                           | 0 to 1.2 In (1)  | 0.7 In (1)      |
| E d C 1<br>★ | <input type="checkbox"/> <b>[Auto DC inj. time 1]</b><br><br>Standstill injection time. This parameter can be accessed if [Auto DC injection] (AdC) page 139 is not [No] (nO)<br>If [Motor control type] (Ctt) page 69 = [FVC] (FUC) or [Sync. mot.] (SYn) this time corresponds to the zero speed maintenance time. | 0.1 to 30 s      | 0.5 s           |
| SdC2<br>★    | <input type="checkbox"/> <b>[Auto DC inj. level 2]</b><br><br>2 <sup>nd</sup> level of standstill DC injection current.<br>This parameter can be accessed if [Auto DC injection] (AdC) page 139 is not [No] (nO)<br>This parameter is forced to 0 if [Motor control type] (Ctt) page 69 = [Sync. mot.] (SYn).        | 0 to 1.2 In (1)  | 0.5 In (1)      |
| E d C 2<br>★ | <input type="checkbox"/> <b>[Auto DC inj. time 2]</b><br><br>2 <sup>nd</sup> standstill injection time.<br>This parameter can be accessed if [Auto DC injection] (AdC) page 139 = [Yes] (YES)  | 0 to 30 s        | 0 s             |





  

| AdC         | SdC2 | Operation |
|-------------|------|-----------|
| YES         | x    |           |
| Ct          | ≠ 0  |           |
| Ct          | = 0  |           |
| Run command |      |           |
| Speed       |      |           |

**Note:** When [Motor control type] (Ctt) page 69 = [FVC] (FUC):  
 [Auto DC inj. level 1] (SdC1), [Auto DC inj. level 2] (SdC2) and [Auto DC inj. time 2] (tdC2) are not accessible. Only [Auto DC inj. time 1] (tdC1) can be accessed. This then corresponds to a zero speed maintenance time.

(1) In corresponds to the rated drive current indicated in the Installation Manual or on the drive nameplate.

## [1.3 SETTINGS] (SEt-)

| Code  | Name/Description   | Adjustment range    | Factory setting     |
|---|--|---------------------|---------------------|
| SFr   | <p><input type="checkbox"/> <b>[Switching freq.]</b></p> <p>Switching frequency setting.<br/> <b>Adjustment range:</b> This can vary between 1 and 16 kHz, but the minimum and maximum values, as well as the factory setting, can be limited in accordance with the type of drive (ATV71H or W), the rating and the configuration of the <a href="#">[Sinus filter] (OFI)</a> and <a href="#">[Motor surge limit] (SUL)</a> parameters, page <a href="#">80</a>.</p> <p>If the value is less than 2 kHz, <a href="#">[Current Limitation] (CLI)</a> and <a href="#">[I Limit. 2 value] (CL2)</a> page <a href="#">59</a> are limited to 1.36 In.</p> <p>Adjustment with drive running:</p> <ul style="list-style-type: none"> <li>- If the initial value is less than 2 kHz, it is not possible to increase it above 1.9 kHz while running.</li> <li>- If the initial value is greater than or equal to 2 kHz, a minimum of 2 kHz must be maintained while running.</li> </ul> <p>Adjustment with the drive stopped: No restrictions.</p> <p> <b>Note:</b> In the event of excessive temperature rise, the drive will automatically reduce the switching frequency and reset it once the temperature returns to normal.</p> <p> <b>Note:</b> If <a href="#">[Motor control type] (Ctt)</a> page <a href="#">69</a> = <a href="#">[FVC] (FUC)</a>, we do not recommend setting the switching frequency to a value less than 2 kHz (in order to avoid speed instability).</p> | According to rating | According to rating |
| <b>CAUTION</b>  |  |                     |                     |
| On ATV71●075N4 to U40N4, drives, if the RFI filters are disconnected (operation on an IT system), the drive's switching frequency must not exceed 4 kHz.<br><b>Failure to follow this instruction can result in equipment damage.</b> |  |                     |                     |
| CL1   | <p><input type="checkbox"/> <b>[Current Limitation]</b></p> <p>Used to limit the motor current.<br/> The adjustment range is limited to 1.36 In if <a href="#">[Switching freq.] (SFr)</a> page <a href="#">59</a> is less than 2 kHz.</p> <p> <b>Note:</b> If the setting is less than 0.25 In, the drive may lock in <a href="#">[Output Phase Loss] (OPF)</a> fault mode if this has been enabled (see page <a href="#">217</a>). If it is less than the no-load motor current, the limitation no longer has any effect.</p>   | 0 to 1.65 In (1)    | 1.5 In (1)          |
| CL2   | <p><input type="checkbox"/> <b>[I Limit. 2 value]</b></p> <p>See page <a href="#">184</a><br/> The adjustment range is limited to 1.36 In if <a href="#">[Switching freq.] (SFr)</a> page <a href="#">59</a> is less than 2 kHz.</p> <p> <b>Note:</b> If the setting is less than 0.25 In, the drive may lock in <a href="#">[Output Phase Loss] (OPF)</a> fault mode if this has been enabled (see page <a href="#">217</a>). If it is less than the no-load motor current, the limitation no longer has any effect.</p>   | 0 to 1.65 In (1)    | 1.5 In (1)          |

(1) In corresponds to the rated drive current indicated in the Installation Manual or on the drive nameplate.

 These parameters only appear if the corresponding function has been selected in another menu. When the parameters can also be accessed and adjusted from within the configuration menu for the corresponding function, their description is detailed in these menus, on the pages indicated, to aid programming.

## [1.3 SETTINGS] (SEt-)

| Code   | Name/Description  | Adjustment range | Factory setting   |
|--|---|------------------|-------------------|
| <b>FLU</b><br><br><b>FnC</b><br><b>FCE</b><br><br><b>FnD</b> | <input type="checkbox"/> <b>[Motor fluxing]</b><br><br><input type="checkbox"/> <b>[Not cont.] (FnC)</b> : Non-continuous mode<br><input type="checkbox"/> <b>[Continuous] (Fct)</b> : Continuous mode. This option is not possible if <b>[Auto DC injection] (AdC)</b> page 139 is <b>[Yes] (YES)</b> or if <b>[Type of stop] (Stt)</b> page 137 is <b>[Freewheel] (nSt)</b> .<br><input type="checkbox"/> <b>[No] (FnO)</b> : Function inactive This option is not possible if <b>[Motor control type] (Ctt)</b> page 69 = <b>[SVCI] (CUC)</b> or <b>[FVC] (FUC)</b> .<br>If <b>[Motor control type] (Ctt)</b> page 69 = <b>[SVCI] (CUC)</b> , <b>[FVC] (FUC)</b> or <b>[Sync. mot.] (SYn)</b> the factory setting is replaced by <b>[Not cont.] (FnC)</b> .<br><br>In order to obtain rapid high torque on startup, magnetic flux needs to already have been established in the motor.<br><ul style="list-style-type: none"> <li>In <b>[Continuous] (Fct)</b> mode, the drive automatically builds up flux when it is powered up.</li> <li>In <b>[Not cont.] (FnC)</b> mode, fluxing occurs when the motor starts up.</li> </ul> The flux current is greater than nCr (configured rated motor current) when the flux is established and is then adjusted to the motor magnetizing current...<br><br><div style="border: 1px solid black; padding: 5px; text-align: center;"> <b>CAUTION</b> </div> <div style="border: 1px solid black; padding: 5px;">                     Check that the motor will withstand this current without overheating.<br/> <b>Failure to follow this instruction can result in equipment damage.</b> </div><br>If <b>[Motor control type] (Ctt)</b> page 69 = <b>[Sync. mot.] (SYn)</b> , the <b>[Motor fluxing] (FLU)</b> parameter causes the alignment of the rotor and not the fluxing.<br>If <b>[Brake assignment] (bLC)</b> page 157 is not <b>[No] (nO)</b> , the <b>[Motor fluxing] (FLU)</b> parameter has no effect. |                  | <b>[No] (FnO)</b> |
| <b>tLS</b>   | <input type="checkbox"/> <b>[Low speed time out]</b><br><br>Maximum operating time at <b>[Low speed] (LSP)</b> (see page 42)<br>Following operation at LSP for a defined period, a motor stop is requested automatically. The motor will restart if the reference is greater than LSP and if a run command is still present.<br>Caution: A value of 0 indicates an unlimited period of time.<br><br> <b>Note:</b> If <b>[Low speed time out] (tLS)</b> is not 0, <b>[Type of stop] (Stt)</b> page 137 is forced to <b>[Ramp stop] (rMP)</b> (only if a ramp stop can be configured).   | 0 to 999.9 s     | 0 s               |
| <b>JGF</b><br><br>★  | <input type="checkbox"/> <b>[Jog frequency]</b><br><br>See page 141<br>Reference in jog operation   | 0 to 10 Hz       | 10 Hz             |
| <b>JGt</b><br><br>★  | <input type="checkbox"/> <b>[Jog delay]</b><br><br>See page 141<br>Anti-repeat delay between 2 consecutive jog operations.  | 0 to 2.0 s       | 0.5 s             |

(1) In corresponds to the rated drive current indicated in the Installation Manual or on the drive nameplate.

★ These parameters only appear if the corresponding function has been selected in another menu. When the parameters can also be accessed and adjusted from within the configuration menu for the corresponding function, their description is detailed in these menus, on the pages indicated, to aid programming.

## [1.3 SETTINGS] (SEt-)

| Code      | Name/Description  | Adjustment range | Factory setting |
|-----------|---|------------------|-----------------|
| SP2<br>★  | <input type="checkbox"/> [Preset speed 2]<br><br>See page 144<br>Preset speed 2   | 0 to 1600 Hz     | 10 Hz           |
| SP3<br>★  | <input type="checkbox"/> [Preset speed 3]<br><br>See page 144<br>Preset speed 3   | 0 to 1600 Hz     | 15 Hz           |
| SP4<br>★  | <input type="checkbox"/> [Preset speed 4]<br><br>See page 144<br>Preset speed 4   | 0 to 1600 Hz     | 20 Hz           |
| SP5<br>★  | <input type="checkbox"/> [Preset speed 5]<br><br>See page 144<br>Preset speed 5   | 0 to 1600 Hz     | 25 Hz           |
| SP6<br>★  | <input type="checkbox"/> [Preset speed 6]<br><br>See page 144<br>Preset speed 6   | 0 to 1600 Hz     | 30 Hz           |
| SP7<br>★  | <input type="checkbox"/> [Preset speed 7]<br><br>See page 144<br>Preset speed 7   | 0 to 1600 Hz     | 35 Hz           |
| SP8<br>★  | <input type="checkbox"/> [Preset speed 8]<br><br>See page 144<br>Preset speed 8   | 0 to 1600 Hz     | 40 Hz           |
| SP9<br>★  | <input type="checkbox"/> [Preset speed 9]<br><br>See page 144<br>Preset speed 9   | 0 to 1600 Hz     | 45 Hz           |
| SP10<br>★ | <input type="checkbox"/> [Preset speed 10]<br><br>See page 144<br>Preset speed 10 | 0 to 1600 Hz     | 50 Hz           |
| SP11<br>★ | <input type="checkbox"/> [Preset speed 11]<br><br>See page 144<br>Preset speed 11 | 0 to 1600 Hz     | 55 Hz           |
| SP12<br>★ | <input type="checkbox"/> [Preset speed 12]<br><br>See page 144<br>Preset speed 12 | 0 to 1600 Hz     | 60 Hz           |
| SP13<br>★ | <input type="checkbox"/> [Preset speed 13]<br><br>See page 144<br>Preset speed 13 | 0 to 1600 Hz     | 70 Hz           |
| SP14<br>★ | <input type="checkbox"/> [Preset speed 14]<br><br>See page 144<br>Preset speed 14 | 0 to 1600 Hz     | 80 Hz           |

★ These parameters only appear if the corresponding function has been selected in another menu. When the parameters can also be accessed and adjusted from within the configuration menu for the corresponding function, their description is detailed in these menus, on the pages indicated, to aid programming.

## [1.3 SETTINGS] (SEt-)

| Code       | Name/Description   | Adjustment range                                  | Factory setting |
|------------|--|---|-----------------|
| SP 15<br>★ | <input type="checkbox"/> [Preset speed 15]<br><br>See page 144<br>Preset speed 15  | 0 to 1600 Hz                                      | 90 Hz           |
| SP 16<br>★ | <input type="checkbox"/> [Preset speed 16]<br><br>See page 144<br>Preset speed 16  | 0 to 1600 Hz                                      | 100 Hz          |
| PF r       | <input type="checkbox"/> [Multiplying coeff.]<br><br>Multiplying coefficient, can be accessed if [Multiplier ref.-] (MA2,MA3) page 133 has been assigned to the graphic terminal           | 0 to 100%   | 100%            |
| S r P<br>★ | <input type="checkbox"/> [+/-Speed limitation]<br><br>See page 148<br>Limitation of +/- speed variation  | 0 to 50%  | 10%             |
| r P G<br>★ | <input type="checkbox"/> [PID prop. gain]<br><br>See page 173<br>Proportional gain   | 0.01 to 100                                       | 1               |
| r I G<br>★ | <input type="checkbox"/> [PID integral gain]<br><br>See page 174<br>Integral gain  | 0.01 to 100                                       | 1               |
| r d G<br>★ | <input type="checkbox"/> [PID derivative gain]<br><br>See page 174<br>Derivative gain  | 0.00 to 100                                       | 0               |
| P r P<br>★ | <input type="checkbox"/> [PID ramp]<br><br>See page 174<br>PID acceleration/deceleration ramp, defined to go from [Min PID reference] (PIP1) to [Max PID reference] (PIP2) and vice versa. | 0 to 99.9 s                                       | 0               |
| P D L<br>★ | <input type="checkbox"/> [Min PID output]<br><br>See page 174<br>Minimum value of regulator output in Hz   | - 500 to 500 or -1600 to 1600 according to rating | 0 Hz            |
| P D H<br>★ | <input type="checkbox"/> [Max PID output]<br><br>See page 174<br>Maximum value of regulator output in Hz   | 0 to 500 or 1600 according to rating              | 60 Hz           |
| P A L<br>★ | <input type="checkbox"/> [Min fbk alarm]<br><br>See page 174<br>Minimum monitoring threshold for regulator feedback  | See page 174 (1)                                  | 100             |
| P A H<br>★ | <input type="checkbox"/> [Max fbk alarm]<br><br>See page 174<br>Maximum monitoring threshold for regulator feedback  | See page 174 (1)                                  | 1000            |

(1) If a graphic display terminal is not in use, values greater than 9999 will be displayed on the 4-digit display with a period mark after the thousand digit, e.g., 15.65 for 15650.

★ These parameters only appear if the corresponding function has been selected in another menu. When the parameters can also be accessed and adjusted from within the configuration menu for the corresponding function, their description is detailed in these menus, on the pages indicated, to aid programming.

## [1.3 SETTINGS] (SEt-)

| Code            | Name/Description  | Adjustment range            | Factory setting |
|-----------------|---|-----------------------------|-----------------|
| <i>PEr</i><br>★ | <input type="checkbox"/> <b>[PID error Alarm]</b><br>See page 174<br>Regulator error monitoring threshold   | 0 to 65535 (1)              | 100             |
| <i>PSr</i><br>★ | <input type="checkbox"/> <b>[Speed input %]</b><br>See page 175<br>Multiplying coefficient for predictive speed input.  | 1 to 100%                   | 100%            |
| <i>rP2</i><br>★ | <input type="checkbox"/> <b>[Preset ref. PID 2]</b><br>See page 177<br>Preset PID reference   | See page 177 (1)            | 300             |
| <i>rP3</i><br>★ | <input type="checkbox"/> <b>[Preset ref. PID 3]</b><br>See page 177<br>Preset PID reference   | See page 177 (1)            | 600             |
| <i>rP4</i><br>★ | <input type="checkbox"/> <b>[Preset ref. PID 4]</b><br>See page 177<br>Preset PID reference   | See page 177 (1)            | 900             |
| <i>Ibr</i><br>★ | <input type="checkbox"/> <b>[Brake release I FW]</b><br>See page 157<br>Brake release current threshold for lifting or forward movement   | 0 to 1.32 In (2)            | 0               |
| <i>Ird</i><br>★ | <input type="checkbox"/> <b>[Brake release I Rev]</b><br>See page 157<br>Brake release current threshold for lowering or reverse movement   | 0 to 1.32 In (2)            | 0               |
| <i>brt</i><br>★ | <input type="checkbox"/> <b>[Brake Release time]</b><br>See page 158<br>Brake release time delay  | 0 to 5.00 s                 | 0 s             |
| <i>blr</i><br>★ | <input type="checkbox"/> <b>[Brake release freq]</b><br>See page 158<br>Brake release frequency threshold   | [Auto] (AUtO)<br>0 to 10 Hz | [Auto] (AUtO)   |
| <i>bEn</i><br>★ | <input type="checkbox"/> <b>[Brake engage freq]</b><br>See page 158<br>Brake engage frequency threshold   | [Auto] (AUtO)<br>0 to 10 Hz | [Auto] (AUtO)   |
| <i>tBE</i><br>★ | <input type="checkbox"/> <b>[Brake engage delay]</b><br>See page 158<br>Time delay before request to engage brake. To delay the engaging of the brake, for horizontal movement only, if you wish the brake to engage when the drive comes to a complete stop. | 0 to 5.00 s                 | 0 s             |

(1) If a graphic display terminal is not in use, values greater than 9999 will be displayed on the 4-digit display with a period mark after the thousand digit, e.g., 15.65 for 15650.

(2) In corresponds to the rated drive current indicated in the Installation Manual or on the drive nameplate.

★ These parameters only appear if the corresponding function has been selected in another menu. When the parameters can also be accessed and adjusted from within the configuration menu for the corresponding function, their description is detailed in these menus, on the pages indicated, to aid programming.

## [1.3 SETTINGS] (SEt-)

| Code             | Name/Description   | Adjustment range                 | Factory setting |
|------------------|--|----------------------------------|-----------------|
| <b>BEt</b><br>★  | <input type="checkbox"/> <b>[Brake engage time]</b><br><br>See page 158<br>Brake engage time (brake response time)   | 0 to 5.00 s                      | 0 s             |
| <b>JdC</b><br>★  | <input type="checkbox"/> <b>[Jump at reversal]</b><br><br>See page 159   | [Auto] (AUtO)<br>0 to 10 Hz      | [Auto] (AUtO)   |
| <b>EEr</b><br>★  | <input type="checkbox"/> <b>[Time to restart]</b><br><br>See page 159<br>Time between the end of a brake engage sequence and the start of a brake release sequence   | 0 to 5.00 s                      | 0 s             |
| <b>ELIN</b><br>★ | <input type="checkbox"/> <b>[Motoring torque lim]</b><br><br>See page 182<br>Torque limitation in generator mode, as a % or in 0.1% increments of the rated torque in accordance with the [Torque increment] (IntP) parameter, page 182. | 0 to 300%                        | 100%            |
| <b>ELIG</b><br>★ | <input type="checkbox"/> <b>[Gen. torque lim]</b><br><br>See page 182<br>Torque limitation in generator mode, as a % or in 0.1% increments of the rated torque in accordance with the [Torque increment] (IntP) parameter, page 182.     | 0 to 300%                        | 100%            |
| <b>ErH</b><br>★  | <input type="checkbox"/> <b>[Traverse freq. high]</b><br><br>See page 205  | 0 to 10 Hz                       | 4 Hz            |
| <b>ErL</b><br>★  | <input type="checkbox"/> <b>[Traverse freq. low]</b><br><br>See page 205   | 0 to 10 Hz                       | 4 Hz            |
| <b>q5H</b><br>★  | <input type="checkbox"/> <b>[Quick step High]</b><br><br>See page 205  | 0 to [Traverse freq. high] (trH) | 0 Hz            |
| <b>q5L</b><br>★  | <input type="checkbox"/> <b>[Quick step Low]</b><br><br>See page 205   | 0 to [Traverse freq. low] (trL)  | 0 Hz            |
| <b>Ctd</b>       | <input type="checkbox"/> <b>[Current threshold]</b><br><br>Current threshold for [I attained] (CtA) function assigned to a relay or a logic output (see page 100).   | 0 to 1.5 In (1)                  | In (1)          |
| <b>EEH</b>       | <input type="checkbox"/> <b>[High torque thd.]</b><br><br>High current threshold for [High tq. att.] (ttHA) function assigned to a relay or a logic output (see page 100), as a % of the rated motor torque.                             | -300% to +300%                   | 100%            |
| <b>EEl</b>       | <input type="checkbox"/> <b>[Low torque thd.]</b><br><br>Low current threshold for [Low tq. att.] (ttLA) function assigned to a relay or a logic output (see page 100), as a % of the rated motor torque.                                | -300% to +300%                   | 50%             |

(1) In corresponds to the rated drive current indicated in the Installation Manual or on the drive nameplate.

★ These parameters only appear if the corresponding function has been selected in another menu. When the parameters can also be accessed and adjusted from within the configuration menu for the corresponding function, their description is detailed in these menus, on the pages indicated, to aid programming.



## [1.3 SETTINGS] (SEt-)

| Code     | Name/Description  | Adjustment range  | Factory setting                    |
|----------|---|-------------------|------------------------------------|
| F9L<br>★ | <input type="checkbox"/> <b>[Pulse warning thd.]</b><br>Speed threshold measured by the <a href="#">FREQUENCY METER</a> FqF-) function, page <a href="#">228</a> , assigned to a relay or a logic output (see page <a href="#">100</a> ).   | 0 Hz to 30.00 kHz | 0 Hz                               |
| Ftd      | <input type="checkbox"/> <b>[Freq. threshold]</b><br>Frequency threshold for <a href="#">[Freq.Th.att.]</a> (FtA) function assigned to a relay or a logic output (see page <a href="#">100</a> ), or used by the <a href="#">[PARAM. SET SWITCHING]</a> (MLP-) function, page <a href="#">195</a> .   | 0.0 to 1600 Hz    | <a href="#">[High speed]</a> (HSP) |
| F2d      | <input type="checkbox"/> <b>[Freq. threshold 2]</b><br>Frequency threshold for <a href="#">[Freq. Th. 2 attain.]</a> (F2A) function assigned to a relay or a logic output (see page <a href="#">100</a> ), or used by the <a href="#">[PARAM. SET SWITCHING]</a> (MLP-) function, page <a href="#">195</a> .  | 0.0 to 1600 Hz    | <a href="#">[High speed]</a> (HSP) |
| FFt<br>★ | <input type="checkbox"/> <b>[Freewheel stop Thd]</b><br>See page <a href="#">137</a><br>This parameter supports switching from a ramp stop or a fast stop to a freewheel stop below a low speed threshold.<br>It can be accessed if <a href="#">[Type of stop]</a> (Stt) = <a href="#">[Fast stop]</a> (FSt) or <a href="#">[Ramp stop]</a> (rMP).<br><input type="checkbox"/> 0.0: Does not switch to freewheel stop.<br><input type="checkbox"/> 0,1 to 1600 Hz: Speed threshold below which the motor will switch to freewheel stop. | 0.0 to 1600 Hz    | 0.0 Hz                             |
| ttt<br>★ | <input type="checkbox"/> <b>[Motor therm. level]</b><br>See page <a href="#">217</a><br>Trip threshold for motor thermal alarm (logic output or relay)  | 0 to 118%         | 100%                               |
| LbC<br>★ | <input type="checkbox"/> <b>[Load correction]</b><br>See page <a href="#">82</a><br>Rated correction in Hz.   | 0 to 1000 Hz      | 0                                  |

★ These parameters only appear if the corresponding function has been selected in another menu. When the parameters can also be accessed and adjusted from within the configuration menu for the corresponding function, their description is detailed in these menus, on the pages indicated, to aid programming.

# [1.4 MOTOR CONTROL] (drC-)

With graphic display terminal:

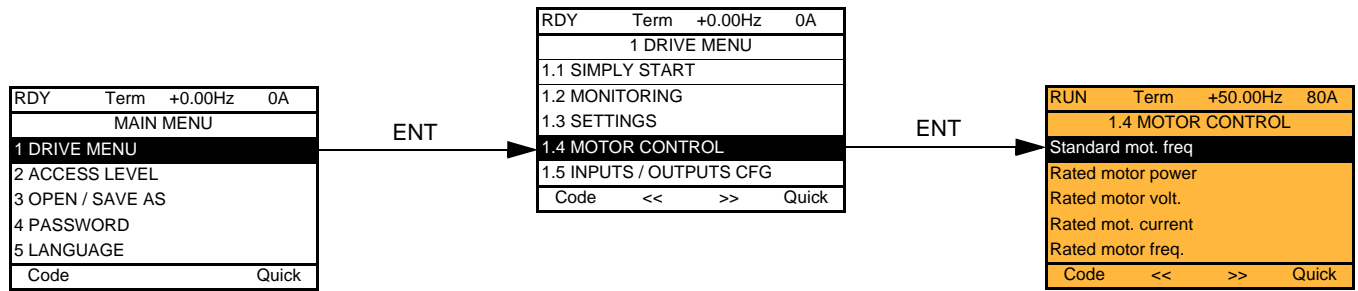

With integrated display terminal:

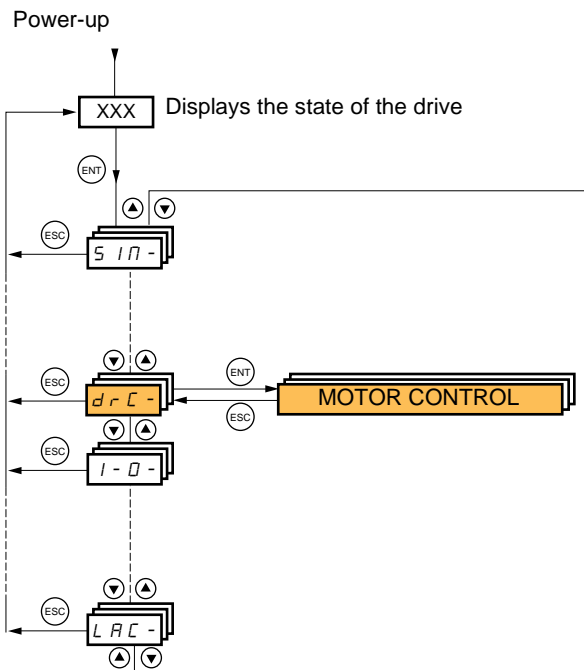

## [1.4 MOTOR CONTROL] (drC-)



The parameters in the [1.4 MOTOR CONTROL] (drC-) menu can only be modified when the drive is stopped and no run command is present, with the following exceptions:

- [Auto tuning] (tUn) page 68, which may cause the motor to start up.
- Parameters containing the sign (C) in the code column, which can be modified with the drive running or stopped.

| Code            | Name/Description   | Adjustment range          | Factory setting  |
|-----------------|--|---------------------------|--|
| bFr<br>50<br>60 | <input type="checkbox"/> [Standard mot. freq]<br><input type="checkbox"/> [50Hz IEC] (50): IEC<br><input type="checkbox"/> [60Hz NEMA] (60): NEMA<br>This parameter modifies the presets of the following parameters: [High speed] (HSP) page 42, [Freq. threshold] (Ftd) page 65, [Rated motor volt.] (UnS), [Rated motor freq.] (FrS) and [Max frequency] (tFr).   |                           | [50Hz IEC] (50)  |
| nPr             | <input type="checkbox"/> [Rated motor power]<br>The parameter cannot be accessed if [Motor control type] (Ctt) page 69 = [Sync. mot.] (SYn).<br>Rated motor power given on the nameplate, in kW if [Standard mot. freq] (bFr) = [50Hz IEC] (50), in HP if [Standard mot. freq] (bFr) = [60Hz NEMA] (60).   | According to drive rating | According to drive rating                                |
| UnS             | <input type="checkbox"/> [Rated motor volt.]<br>The parameter cannot be accessed if [Motor control type] (Ctt) page 69 = [Sync. mot.] (SYn).<br>Rated motor voltage given on the nameplate.<br>ATV71...M3X: 100 to 240 V<br>ATV71...N4: 200 to 480 V   | According to drive rating | According to drive rating and [Standard mot. freq] (bFr) |
| nCr             | <input type="checkbox"/> [Rated mot. current]<br>The parameter cannot be accessed if [Motor control type] (Ctt) page 69 = [Sync. mot.] (SYn).<br>Rated motor current given on the nameplate.   | 0.25 to 1.5 In (1)        | According to drive rating and [Standard mot. freq] (bFr) |
| FrS             | <input type="checkbox"/> [Rated motor freq.]<br>The parameter cannot be accessed if [Motor control type] (Ctt) page 69 = [Sync. mot.] (SYn).<br>Rated motor frequency given on the nameplate.<br>The factory setting is 50 Hz, or preset to 60 Hz if [Standard mot. freq] (bFr) is set to 60 Hz.<br>The maximum value is limited to 500 Hz if [Motor control type] (Ctt) (page 69) is not V/F or if the drive rating is higher than ATV71HD37.<br>Values between 500 Hz and 1600 Hz are only possible in V/F control and for powers limited to 37 kW (50 HP).<br>In this case configure [Motor control type] (Ctt) before [Rated motor freq.] (FrS).   | 10 to 1600 Hz             | 50 Hz  |
| InSP<br>1<br>10 | <input type="checkbox"/> [rpm increment]<br>Increment of parameter [Rated motor speed] (nSP).<br><input type="checkbox"/> [x1 rpm] (1): Increment of 1 rpm, to be used if [Rated motor speed] (nSP) does not exceed 65535 rpm.<br><input type="checkbox"/> [x10 rpm] (10): Increment of 10 rpm, to be used if [Rated motor speed] (nSP) exceeds 65535 rpm.<br> <b>Note:</b> Changing [rpm increment] (InSP) will restore [Rated motor speed] (nSP) to its factory setting.  |                           | [x1 rpm] (1)   |
| nSP             | <input type="checkbox"/> [Rated motor speed]<br>The parameter cannot be accessed if [Motor control type] (Ctt) page 69 = [Sync. mot.] (SYn).<br>Rated motor speed given on the nameplate. Adjustable between 0 and 65535 rpm if [rpm increment] (InSP) = [x1 rpm] (1) or between 0.00 and 96.00 krpm if [rpm increment] (InSP) = [x10 rpm] (10).<br>0 to 9999 rpm then 10.00 to 65.53 or 96.00 krpm on the integrated display terminal.<br>If, rather than the rated speed, the nameplate indicates the synchronous speed and the slip in Hz or as a %, calculate the rated speed as follows: <ul style="list-style-type: none"> <li>• Nominal speed = Synchronous speed x <math>\frac{100 - \text{slip as a \%}}{100}</math></li> <li>or</li> <li>• Nominal speed = Synchronous speed x <math>\frac{50 - \text{slip in Hz}}{50}</math> (50 Hz motors)</li> <li>or</li> <li>• Nominal speed = Synchronous speed x <math>\frac{60 - \text{slip in Hz}}{60}</math> (60 Hz motors)</li> </ul> | 0 to 96000 rpm            | According to drive rating                                |

(1) In corresponds to the rated drive current indicated in the Installation Manual and on the drive nameplate.

## [1.4 MOTOR CONTROL] (drC-)

| Code   | Name/Description  | Factory setting         |
|--|---|-------------------------|
| <b>tFr</b>   | <p><input type="checkbox"/> <b>[Max frequency]</b></p> <p>The factory setting is 60 Hz, or preset to 72 Hz if <b>[Standard mot. freq] (bFr)</b> is set to 60 Hz. The maximum value is limited by the following conditions:</p> <ul style="list-style-type: none"> <li>It must not exceed 10 times the value of <b>[Rated motor freq.] (FrS)</b></li> <li>It must not exceed 500 Hz if <b>[Motor control type] (Ctt)</b> (page 69) is not V/F or if the drive rating is higher than ATV71HD37.</li> </ul> <p>Values between 500 Hz and 1600 Hz are only possible in V/F control and for powers limited to 37 kW (50 HP). In this case configure <b>[Motor control type] (Ctt)</b> before <b>[Max frequency] (tFr)</b>.</p>   | 10 to 1600 Hz           |
| <b>tUn</b><br><b>nO</b><br><b>YES</b><br><b>dOnE</b>   | <p><input type="checkbox"/> <b>[Auto tuning]</b></p> <p><input type="checkbox"/> <b>[No] (nO)</b>: Auto-tuning not performed.</p> <p><input type="checkbox"/> <b>[Yes] (YES)</b>: Auto-tuning is performed as soon as possible, then the parameter automatically changes to <b>[Done] (dOnE)</b>.</p> <p><input type="checkbox"/> <b>[Done] (dOnE)</b>: Use of the values given the last time auto-tuning was performed.</p> <p><b>Caution:</b></p> <ul style="list-style-type: none"> <li>It is essential that all the motor parameters are correctly configured before starting auto-tuning. <ul style="list-style-type: none"> <li>Asynchronous motor: <b>[Rated motor volt.] (UnS)</b>, <b>[Rated motor freq.] (FrS)</b>, <b>[Rated mot. current] (nCr)</b>, <b>[Rated motor speed] (nSP)</b>, <b>[Rated motor power] (nPr)</b></li> <li>Synchronous motor: <b>[Nominal I sync.] (nCrS)</b>, <b>[Nom motor spdsync] (nSPS)</b>, <b>[Pole pairs] (PPnS)</b>, <b>[Syn. EMF constant] (PHS)</b>, <b>[Autotune L d-axis] (LdS)</b>, <b>[Autotune L q-axis] (LqS)</b></li> </ul> </li> </ul> <p>If one or more of these parameters is modified after auto-tuning has been performed, <b>[Auto tuning] (tUn)</b> will return to <b>[No] (nO)</b> and the procedure must be repeated.</p> <ul style="list-style-type: none"> <li>Auto-tuning is only performed if no stop command has been activated. If a "freewheel stop" or "fast stop" function has been assigned to a logic input, this input must be set to 1 (active at 0).</li> <li>Auto-tuning takes priority over any run or prefluxing commands, which will be taken into account after the auto-tuning sequence.</li> <li>If auto-tuning fails, the drive displays <b>[No] (nO)</b> and, depending on the configuration of <b>[Autotune fault mgt] (tnL)</b> page 231, may switch to <b>[Auto-tuning] (tnF)</b> fault mode.</li> <li>Auto-tuning may last for 1 to 2 seconds. Do not interrupt the process. Wait for the display to change to <b>"[Done] (dOnE)"</b> or <b>"[No] (nO)"</b>.</li> </ul> <p> <b>Note:</b> During auto-tuning the motor operates at rated current.</p> | <b>[No] (nO)</b>        |
| <b>AutE</b><br><b>nO</b><br><b>YES</b>   | <p><input type="checkbox"/> <b>[Automatic autotune]</b></p> <p><input type="checkbox"/> <b>[No] (nO)</b>: Function inactive</p> <p><input type="checkbox"/> <b>[Yes] (YES)</b>: Auto-tuning is performed on every power-up.</p> <p><b>Caution:</b> Same comments as for <b>[Auto tuning] (tUn)</b> above.</p>   | <b>[No] (nO)</b>        |
| <b>tUS</b><br><b>tAb</b><br><b>PEnd</b><br><b>PrOG</b><br><b>FAIL</b><br><b>dOnE</b><br><b>CUS</b> | <p><input type="checkbox"/> <b>[Auto tuning state]</b></p> <p>For information only, cannot be modified.</p> <p><input type="checkbox"/> <b>[Not done] (tAb)</b>: The default stator resistance value is used to control the motor.</p> <p><input type="checkbox"/> <b>[Pending] (PEnd)</b>: Auto-tuning has been requested but not yet performed.</p> <p><input type="checkbox"/> <b>[In Progress] (PrOG)</b>: Auto-tuning in progress</p> <p><input type="checkbox"/> <b>[Failed] (FAIL)</b>: Auto-tuning has failed.</p> <p><input type="checkbox"/> <b>[Done] (dOnE)</b>: The stator resistance measured by the auto-tuning function is used to control the motor.</p> <p><input type="checkbox"/> <b>[Customized] (CUS)</b>: Auto-tuning has been performed, but at least one parameter set by this auto-tuning operation has subsequently been modified. The <b>[Auto tuning] (tUn)</b> parameter then returns to <b>[No] (nO)</b>. The following auto-tuning parameters are affected:<br/><b>[Cust. stator R syn] (rSAS)</b> page 72, <b>[Cust stator resist.] (rSA)</b>, <b>[ldw] (ldA)</b>, <b>[LFw] (LFA)</b> and <b>[T2w] (trA)</b> page 73.</p>  | <b>[Not done] (tAb)</b> |
| <b>PHr</b><br><b>AbC</b><br><b>ACb</b>   | <p><input type="checkbox"/> <b>[Output Ph rotation]</b></p> <p><input type="checkbox"/> <b>[ABC] (AbC)</b>: Forward</p> <p><input type="checkbox"/> <b>[ACB] (ACb)</b>: Reverse</p> <p>This parameter can be used to reverse the direction of rotation of the motor without reversing the wiring.</p> <p> <b>Do not modify the [Output Ph rotation] (PHr) parameter when [Motor control type] (Ctt) page 69 = [FVC] (FUC).</b> The direction of rotation must be modified, if required, before or during the procedure to check the encoder page 76 when <b>[Motor control type] (Ctt)</b> is not <b>[FVC] (FUC)</b>.</p>  | <b>[ABC] (AbC)</b>      |

# [1.4 MOTOR CONTROL] (drC-)

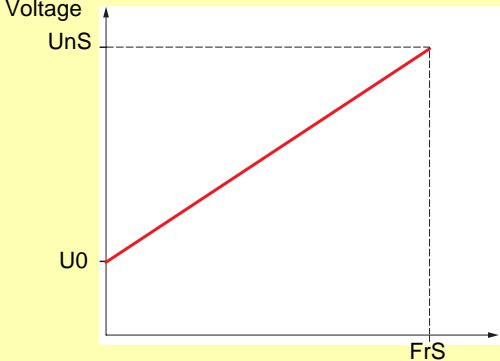
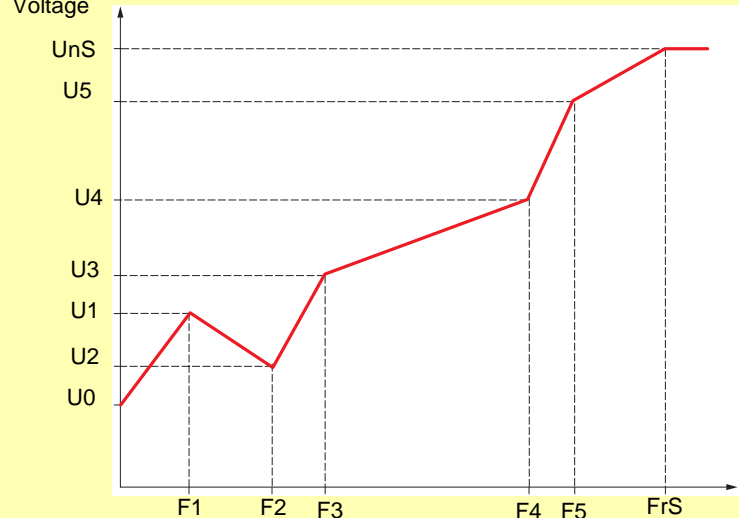
| Code         | Name/Description   | Adjustment range | Factory setting      |
|--------------|--|------------------|----------------------|
| <b>C E E</b> | <input type="checkbox"/> <b>[Motor control type]</b>   |                  | <b>[SVC V] (UUC)</b> |
| <b>U U C</b> | <input type="checkbox"/> <b>[SVC V] (UUC)</b> : Open-loop voltage flux vector control. This type of control is recommended when replacing an ATV58. It supports operation with a number of motors connected in parallel on the same drive.   |                  |                      |
| <b>C U C</b> | <input type="checkbox"/> <b>[SVC I] (CUC)</b> : Open-loop current flux vector control. This type of control is recommended when replacing an ATV58F used in an open-loop configuration. It does not support operation with a number of motors connected in parallel on the same drive.   |                  |                      |
| <b>F U C</b> | <input type="checkbox"/> <b>[FVC] (FUC)</b> : Closed-loop current flux vector control for motor with incremental encoder type sensor, can only be selected if an encoder card has been inserted. This type of control is recommended when replacing an ATV58F used in a closed-loop configuration. It provides better performance in terms of speed and torque accuracy and enables torque to be obtained at zero speed. It does not support operation with a number of motors connected in parallel on the same drive.<br> <b>It is essential that the encoder check page 76 is performed successfully before selecting [FVC] (FUC).</b> |                  |                      |
| <b>U F 2</b> | <input type="checkbox"/> <b>[V/F 2pts] (UF2)</b> : Simple V/F profile without slip compensation. It supports operation with: <ul style="list-style-type: none"> <li>- Special motors (wound rotor, tapered rotor, etc.)</li> <li>- A number of motors in parallel on the same drive</li> <li>- High-speed motors</li> <li>- Motors with a low power rating in comparison to that of the drive</li> </ul>   |                  |                      |
|              |  <p>The profile is defined by the values of parameters UnS, FrS and U0.</p>  |                  |                      |
| <b>U F 5</b> | <input type="checkbox"/> <b>[V/F 5pts] (UF5)</b> : 5-segment V/F profile: As V/F 2 pts profile but also supports the avoidance of resonance (saturation).  |                  |                      |
|              |  <p>The profile is defined by the values of parameters UnS, FrS, U0 to U5 and F0 to F5.</p> <p><math>FrS &gt; F5 &gt; F4 &gt; F3 &gt; F2 &gt; F1</math></p>  |                  |                      |
| <b>S Y n</b> | <input type="checkbox"/> <b>[Sync. mot.] (SYn)</b> : For synchronous permanent magnet motors with sinusoidal electromotive force (EMF) only. This selection makes the asynchronous motor parameters inaccessible, and the synchronous motor parameters accessible  |                  |                      |

## [1.4 MOTOR CONTROL] (drC-)

| Code       | Name/Description  | Adjustment range                       | Factory setting |
|------------|---|--|-----------------|
| <b>U 0</b> | <input type="checkbox"/> <b>[U0]</b><br><br>V/F profile setting. The parameter can be accessed if [Motor control type] (Ctt) = [V/F 2pts] (UF2) or [V/F 5pts] (UF5) | 0 to 600 or 1000 V according to rating | 0               |
| <b>U 1</b> | <input type="checkbox"/> <b>[U1]</b><br><br>V/F profile setting. The parameter can be accessed if [Motor control type] (Ctt) = [V/F 5pts] (UF5)                     | 0 to 600 or 1000 V according to rating | 0               |
| <b>F 1</b> | <input type="checkbox"/> <b>[F1]</b><br><br>V/F profile setting. The parameter can be accessed if [Motor control type] (Ctt) = [V/F 5pts] (UF5)                     | 0 to 1600 Hz                           | 0               |
| <b>U 2</b> | <input type="checkbox"/> <b>[U2]</b><br><br>V/F profile setting. The parameter can be accessed if [Motor control type] (Ctt) = [V/F 5pts] (UF5)                     | 0 to 600 or 1000 V according to rating | 0               |
| <b>F 2</b> | <input type="checkbox"/> <b>[F2]</b><br><br>V/F profile setting. The parameter can be accessed if [Motor control type] (Ctt) = [V/F 5pts] (UF5)                     | 0 to 1600 Hz                           | 0               |
| <b>U 3</b> | <input type="checkbox"/> <b>[U3]</b><br><br>V/F profile setting. The parameter can be accessed if [Motor control type] (Ctt) = [V/F 5pts] (UF5)                     | 0 to 600 or 1000 V according to rating | 0               |
| <b>F 3</b> | <input type="checkbox"/> <b>[F3]</b><br><br>V/F profile setting. The parameter can be accessed if [Motor control type] (Ctt) = [V/F 5pts] (UF5)                     | 0 to 1600 Hz                           | 0               |
| <b>U 4</b> | <input type="checkbox"/> <b>[U4]</b><br><br>V/F profile setting. The parameter can be accessed if [Motor control type] (Ctt) = [V/F 5pts] (UF5)                     | 0 to 600 or 1000 V according to rating | 0               |
| <b>F 4</b> | <input type="checkbox"/> <b>[F4]</b><br><br>V/F profile setting. The parameter can be accessed if [Motor control type] (Ctt) = [V/F 5pts] (UF5)                     | 0 to 1600 Hz                           | 0               |
| <b>U 5</b> | <input type="checkbox"/> <b>[U5]</b><br><br>V/F profile setting. The parameter can be accessed if [Motor control type] (Ctt) = [V/F 5pts] (UF5)                     | 0 to 600 or 1000 V according to rating | 0               |
| <b>F 5</b> | <input type="checkbox"/> <b>[F5]</b><br><br>V/F profile setting. The parameter can be accessed if [Motor control type] (Ctt) = [V/F 5pts] (UF5)                     | 0 to 1600 Hz                           | 0               |

## [1.4 MOTOR CONTROL] (drC-)

| Code             | Name/Description   | Adjustment range  | Factory setting  |
|------------------|--|---|--|
| UC2<br>n0<br>YES | <input type="checkbox"/> <b>[Vector Control 2pt]</b><br><p>The parameter can be accessed if [Motor control type] (Ctt) is not [Sync. mot.] (SYn).</p> <p><input type="checkbox"/> <b>[No] (n0)</b>: Function inactive<br/> <input type="checkbox"/> <b>[Yes] (YES)</b>: Function active.</p> <p>Used in applications in which the motor rated speed and frequency need to be exceeded in order to optimize operation at constant power, or when the maximum voltage of the motor needs to be limited to a value below the line voltage.<br/> The voltage/frequency profile must then be adapted in accordance with the motor's capabilities to operate at maximum voltage UCP and maximum frequency FCP.</p> |   | [No] (n0)  |
| UCP              | <input type="checkbox"/> <b>[V. constant power]</b><br><p>The parameter can be accessed if [Vector Control 2pt] (UC2) = [Yes] (YES)</p>  | According to drive rating                               | According to drive rating and [Standard mot. freq] (bFr) |
| FCP              | <input type="checkbox"/> <b>[Freq. Const Power]</b><br><p>The parameter can be accessed if [Vector Control 2pt] (UC2) = [Yes] (YES)</p>  | According to drive rating and [Rated motor freq.] (FrS) | = [Standard mot. freq] (bFr)                             |

## [1.4 MOTOR CONTROL] (drC-)

### Synchronous motor parameters:

These parameters can be accessed if [Motor control type] (Ctt) page 69 = [Sync. mot.] (SYn). In this case, the asynchronous motor parameters cannot be accessed.

| Code        | Name/Description   | Adjustment range          | Factory setting           |
|-------------|--|---------------------------|---------------------------|
| <i>nCrS</i> | <input type="checkbox"/> [Nominal I sync.]<br>Rated synchronous motor current given on the nameplate.  | 0.25 to 1.5 In (2)        | According to drive rating |
| <i>nSPS</i> | <input type="checkbox"/> [Nom motor spdsync]<br>Rated motor speed given on the nameplate.<br>On the integrated display unit: 0 to 9999 rpm then 10.00 to 60.00 krpm.   | 0 to 60000 rpm            | According to drive rating |
| <i>PPnS</i> | <input type="checkbox"/> [Pole pairs]<br>Number of pairs of poles on the synchronous motor.  | 1 to 50                   | According to drive rating |
| <i>PHS</i>  | <input type="checkbox"/> [Syn. EMF constant]<br>Synchronous motor EMF constant, in mV per rpm (peak voltage per phase).<br>On the integrated display unit: 0 to 9999 then 10.00 to 65.53 (10000 to 65536).   | 0 to 65535                | According to drive rating |
| <i>LdS</i>  | <input type="checkbox"/> [Autotune L d-axis]<br>Axis "d" stator inductance in mH (per phase).<br>On motors with smooth poles [Autotune L d-axis] (LdS) = [Autotune L q-axis] (LqS) = Stator inductance L.  | 0 to 655.3                | According to drive rating |
| <i>LqS</i>  | <input type="checkbox"/> [Autotune L q-axis]<br>Axis "q" stator inductance in mH (per phase).<br>On motors with smooth poles [Autotune L d-axis] (LdS) = [Autotune L q-axis] (LqS) = Stator inductance L.  | 0 to 655.3                | According to drive rating |
| <i>rSRS</i> | <input type="checkbox"/> [Cust. stator R syn]<br>Cold state stator resistance (per winding) The factory setting is replaced by the result of the auto-tuning operation, if it has been performed.<br>The value can be entered by the user, if he knows it.<br>Value in milliohms (mΩ) up to 75 kW (100 HP), in hundredths of milliohms (mΩ/100) above 75 kW (100 HP).<br>On the integrated display unit: 0 to 9999 then 10.00 to 65.53 (10000 to 65536). | According to drive rating | According to drive rating |

| Code       | Name/Description   | Adjustment range | Factory setting |
|------------|--|------------------|-----------------|
| <i>UFr</i> | <input type="checkbox"/> [IR compensation] (1)<br>The parameter can be accessed if [Motor control type] (Ctt) is not [V/F 2pts] (UF2) and [V/F 5pts] (UF5).<br>Used to optimize the torque at very low speed (increase [IR compensation] (UFr) if the torque is insufficient).<br>Check that the [IR compensation] (UFr) value is not too high when the motor is warm (risk of instability).   | 25 to 200%       | 100%            |
| <i>SLP</i> | <input type="checkbox"/> [Slip compensation] (1)<br>The parameter can be accessed if [Motor control type] (Ctt) is not [V/F 2pts] (UF2), [V/F 5pts] (UF5) and [Sync. mot.] (SYn).<br>Adjusts the slip compensation around the value set by the rated motor speed.<br>The speeds given on motor nameplates are not necessarily exact. <ul style="list-style-type: none"> <li>• If slip setting &lt; actual slip: The motor is not rotating at the correct speed in steady state, but at a speed lower than the reference.</li> <li>• If slip setting &gt; actual slip: The motor is overcompensated and the speed is unstable.</li> </ul> | 0 to 300%        | 100%            |

(1) The parameter can also be accessed in the [1.3 SETTINGS] (SEt-) menu.

(2) In corresponds to the rated drive current indicated in the Installation Manual and on the drive nameplate.

 Parameter that can be modified during operation or when stopped.



## [1.4 MOTOR CONTROL] (drC-)

### Motor parameters that can be accessed in [Expert] mode.

These include:

- Parameters calculated by the drive during auto-tuning, in read-only mode. For example, R1r, calculated cold stator resistance.
- The possibility of replacing some of these calculated parameters by other values, if necessary. For example, R1w, measured cold stator resistance.

When a parameter Xyw is modified by the user, the drive uses it in place of the calculated parameter Xyr.

### Asynchronous motor

If an auto-tuning operation is performed or if one of the motor parameters on which auto-tuning depends is modified ([Rated motor volt.] (UnS), [Rated motor freq.] (FrS), [Rated mot. current] (nCr), [Rated motor speed] (nSP), [Rated motor power] (nPr)), parameters Xyw return to their factory settings.

| Code  | Name/Description   |
|-------|--|
| r 5 r | <input type="checkbox"/> <b>[Stator R measured]</b><br>Cold stator resistance, calculated by the drive, in read-only mode. Value in milliohms (mΩ) up to 75 kW (100 HP), in hundredths of milliohms (mΩ/100) above 75 kW (100 HP).   |
| l d r | <input type="checkbox"/> <b>[ldr]</b><br>Magnetizing current in A, calculated by the drive, in read-only mode.   |
| L F r | <input type="checkbox"/> <b>[Lfr]</b><br>Leakage inductance in mH, calculated by the drive, in read-only mode.   |
| t r r | <input type="checkbox"/> <b>[T2r]</b><br>Rotor time constant in mS, calculated by the drive, in read-only mode.  |
| n 5 L | <input type="checkbox"/> <b>[Nominal motor slip]</b><br>Rated slip in Hz, calculated by the drive, in read-only mode.<br>To modify the rated slip, modify the [Rated motor speed] (nSP) (page 67).   |
| P P n | <input type="checkbox"/> <b>[Pr]</b><br>Number of pairs of poles, calculated by the drive, in read-only mode.  |
| r 5 A | <input type="checkbox"/> <b>[Cust stator resist.]</b><br>Cold state stator resistance (per winding), modifiable value. In milliohms (mΩ) up to 75 kW (100 HP), in hundredths of milliohms (mΩ/100) above 75 kW (100 HP). On the integrated display unit: 0 to 9999 then 10.00 to 65.53 (10000 to 65536). |
| l d A | <input type="checkbox"/> <b>[ldw]</b><br>Magnetizing current in A, modifiable value.   |
| L F A | <input type="checkbox"/> <b>[Lfw]</b><br>Leakage inductance in mH, modifiable value.   |
| t r A | <input type="checkbox"/> <b>[T2w]</b><br>Rotor time constant in mS, modifiable value.  |

## [1.4 MOTOR CONTROL] (drC-)

---

### Synchronous motor

| Code           | Name/Description   |
|----------------|--|
| <i>r 5 r 5</i> | <input type="checkbox"/> <b>[R1rS]</b><br>Cold state stator resistance (per winding), in read-only mode. This is the drive factory setting or the result of the auto-tuning operation, if it has been performed.<br>Value in milliohms ( $m\Omega$ ) up to 75 kW (100 HP), in hundredths of milliohms ( $m\Omega/100$ ) above 75 kW (100 HP).<br>On the integrated display unit: 0 to 9999 then 10.00 to 65.53 (10000 to 65536). |
| <i>F r 5 5</i> | <input type="checkbox"/> <b>[Nominal freq sync.]</b><br>Motor frequency at rated speed in Hz, calculated by the drive (rated motor frequency), in read-only mode.  |

## [1.4 MOTOR CONTROL] (drC-)

### Selecting the encoder

Follow the recommendations in the catalog and the Installation Manual.

| Code  | Name/Description   | Adjustment range | Factory setting |
|---|--|------------------|-----------------|
| <i>EnS</i><br><i>nO</i><br><i>AAbb</i><br><i>Ab</i><br><i>A</i> | <input type="checkbox"/> <b>[Encoder type]</b><br><br>To be configured in accordance with the type of card and encoder used (1).<br><input type="checkbox"/> [----] (nO): Card missing.<br><input type="checkbox"/> [AABB] (AAbb): For signals A, A-, B, B-.<br><input type="checkbox"/> [AB] (Ab): For signals A, B.<br><input type="checkbox"/> [A] (A): For signal A. Value cannot be accessed if [Encoder usage] (EnU) page 76 = [Spd fdk reg.] (rEG). |                  | [AABB] (AAbb)   |
| <i>PGI</i>  | <input type="checkbox"/> <b>[Number of pulses]</b><br><br>Number of pulses per encoder revolution.<br>The parameter can be accessed if an encoder card has been inserted (1).  | 100 to 5000      | 1024            |

(1) The encoder parameters can only be accessed if the encoder card has been inserted, and the available selections will depend on the type of encoder card used. The encoder configuration can also be accessed in the [1.5- INPUTS / OUTPUTS CFG] (I/O) menu.

## [1.4 MOTOR CONTROL] (drC-)

### Encoder check procedure

1. Set [Motor control type] (Ctt) to a value other than [FVC] (FUC) even if it is the required configuration.
2. Set up in open-loop mode, following the recommendations on page 5.
3. Set [Encoder usage] (EnU) = [No] (nO).
4. Set [Encoder type] (EnS) and [Number of pulses] (PGI) accordingly for the encoder used.
5. Set [Encoder check] (EnC) = [Yes] (YES)
6. Check that the rotation of the motor is safe.
7. Set the motor rotating at stabilized speed ≈ 15% of the rated speed for at least 3 seconds, and use the [1.2-MONITORING] (SUP-) menu to monitor its behavior.
8. If it trips on an [Encoder fault] (EnF), [Encoder check] (EnC) returns to [No] (nO).
  - Check [Number of pulses] (PGI) and [Encoder type] (EnS).
  - Check that the mechanical and electrical operation of the encoder, its power supply and connections are all correct.
  - Reverse the direction of rotation of the motor ([Output Ph rotation] (PHr) parameter page 68) or the encoder signals.
9. Repeat the operations from 5 onwards until [Encoder check] (EnC) changes to [Done] (dOnE).
10. If necessary, change [Motor control type] (Ctt) to [FVC] (FUC).

| Code                                   | Name/Description   | Adjustment range | Factory setting |
|--|--|------------------|-----------------|
| EnC<br><br>nO<br>YES<br>dOnE           | <input type="checkbox"/> <b>[Encoder check]</b><br><br>Check encoder feedback See the procedure below.<br>The parameter can be accessed if an encoder card has been inserted (1).<br><input type="checkbox"/> <b>[Not done] (nO)</b> Check not performed.<br><input type="checkbox"/> <b>[Yes] (YES)</b> : Activates monitoring of the encoder.<br><input type="checkbox"/> <b>[Done] (dOnE)</b> : Check performed successfully.<br>The check procedure checks: <ul style="list-style-type: none"> <li>- The direction of rotation of the encoder/motor</li> <li>- The presence of signals (wiring continuity)</li> <li>- The number of pulses/revolution</li> </ul> If a fault is detected, the drive locks in [Encoder fault] (EnF) fault mode.  |                  | [Not done] (nO) |
| EnU<br><br>nO<br>SEC<br>rEG<br><br>PGr | <input type="checkbox"/> <b>[Encoder usage]</b><br><br>The parameter can be accessed if an encoder card has been inserted (1).<br><input type="checkbox"/> <b>[No] (nO)</b> : Function inactive<br><input type="checkbox"/> <b>[Fdbk monit.] (SEC)</b> : The encoder provides speed feedback for monitoring only.<br><input type="checkbox"/> <b>[Spd fdk reg.] (rEG)</b> : The encoder provides speed feedback for regulation and monitoring. This configuration is automatic if the drive is configured for closed-loop operation ([Motor control type] (Ctt) = [FVC] (FUC). If [Motor control type] (Ctt) = [SVC V] (UUC) the encoder operates in speed feedback mode and enables static correction of the speed to be performed. This configuration is not accessible for other [Motor control type] (Ctt) values.<br><input type="checkbox"/> <b>[Speed ref.] (PGr)</b> : The encoder provides a reference. |                  | [No] (nO)       |

(1) The encoder parameters can only be accessed if the encoder card has been inserted, and the available selections will depend on the type of encoder card used. The encoder configuration can also be accessed in the [1.5- INPUTS / OUTPUTS CFG] (I/O) menu.

## [1.4 MOTOR CONTROL] (drC-)

### [ENA SYSTEM]

ENA SYSTEM is a control profile designed for rotating machines with unbalanced load. It is used primarily for oil pumps. The operating principle applied:

- Allows operation without a braking resistor
- Reduces mechanical stress on the rod
- Reduces line current fluctuations
- Reduces energy consumption by improving the electric power/current ratio

### [ENA prop.gain]

This setting is used to achieve a compromise between the reduced energy consumption (and/or line current fluctuations) and the mechanical stress to which the rod is subject.

Energy is saved by reducing current fluctuations and increasing the current while retaining the same average speed.

### [ENA integral gain]

This setting is used to smooth the DC bus voltage.

Start up the machine with a low integral and proportional gain (proportional 25% and integral 10%) in order to avoid an overvoltage trip in the absence of a braking resistor. See if these settings are suitable.

### Recommended adjustments to be made during operation:

- To eliminate the braking resistor and, therefore, the increase in the DC bus voltage:  
Display the machine speed on the graphic display terminal.  
Reduce the integral gain value until the machine speed drops. When this point is reached, increase the integral gain until the machine speed stabilizes.  
Use the graphic display terminal or an oscilloscope to check that the DC bus voltage is stable.
- To save energy:  
Reducing the proportional gain (gradually) may increase energy savings by reducing the maximum value of the line current, but it will increase speed variations and, therefore, mechanical stress.  
The aim is to identify settings that will enable energy to be saved and minimize mechanical stress.  
When reducing the proportional gain, it may be necessary to readjust the integral gain in order to avoid an overvoltage trip.

**Note:** Once the adjustments are complete, check that the pump starts up correctly. If the ENA integral gain setting is too low, this may lead to insufficient torque on startup.

### [Reduction ratio]

This setting corresponds to the motor speed ahead of gearbox/speed after gearbox ratio. This parameter is used to display the average speed in Hz and the machine speed in customer units (e.g., in strokes per minute) on the graphic display terminal. In order to be displayed on the graphic display terminal, these values must be selected in the [1.2 MONITORING] (SUP-) menu.







## [1.4 MOTOR CONTROL] (drC-)

| Code                    | Name/Description   | Adjustment range | Factory setting |
|-------------------------|--|------------------|-----------------|
| <b>EnA</b><br>nO<br>YES | <input type="checkbox"/> <b>[ENA system]</b><br>The parameter can be accessed if [Motor control type] (Ctt) = [SVC V] (UUC), see page 69.<br><input type="checkbox"/> <b>[No] (nO)</b> : Function inactive<br><input type="checkbox"/> <b>[Yes] (YES)</b> : Function active. |                  | [No] (nO)       |
| <b>GPE</b><br>⌚         | <input type="checkbox"/> <b>[ENA prop.gain]</b> (1)<br>The parameter can be accessed if [ENA system] (EnA) = [Yes] (YES)   | 1 to 9999        | 250             |
| <b>GIE</b><br>⌚         | <input type="checkbox"/> <b>[ENA integral gain]</b> (1)<br>The parameter can be accessed if [ENA system] (EnA) = [Yes] (YES)   | 0 to 9999        | 100             |
| <b>rRP</b><br>⌚         | <input type="checkbox"/> <b>[Reduction ratio]</b> (1)<br>The parameter can be accessed if [ENA system] (EnA) = [Yes] (YES)   | 10.0 to 999.9    | 10              |

(1) The parameter can also be accessed in the [1.3 SETTINGS] (SEt-) menu.

 Parameter that can be modified during operation or when stopped.

# [1.4 MOTOR CONTROL] (drC-)

| Code   | Name/Description   | Adjustment range    | Factory setting     |
|--|--|---------------------|---------------------|
| <b>OFI</b><br>nO<br>YES  | <input type="checkbox"/> <b>[Sinus filter]</b><br><input type="checkbox"/> <b>[No] (nO)</b> : No sinus filter<br><input type="checkbox"/> <b>[Yes] (YES)</b> : Use of a sinus filter, to limit overvoltages on the motor and reduce the ground fault leakage current.<br><b>[Sinus filter] (OFI)</b> is forced to <b>[No] (nO)</b> on ATV71●037M3 and ATV71●075N4.<br><br> <b>Note:</b> The settings for <b>[Current Limitation] (CLI)</b> and <b>[I Limit. 2 value] (CL2)</b> page 59 must be made once <b>[Sinus filter] (OFI)</b> has been set to <b>[Yes] (YES)</b> and <b>[Motor control type] (Ctt)</b> page 69 has been set to <b>[V/F 2pts] (UF2)</b> or <b>[V/F 5pts] (UF5)</b> . This is due to the fact that for certain ratings, this configuration will result in a reduced factory setting (1.36 In) for current limitations. |                     | <b>[No] (nO)</b>    |
| <b>CAUTION</b>   |  |                     |                     |
| If <b>[Sinus filter] (OFI) = [Yes] (YES)</b> , <b>[Motor control type] (Ctt)</b> page 69 must be <b>[V/F 2pts] (UF2)</b> , <b>[V/F 5pts] (UF5)</b> , or <b>[SVC V] (UUC) only</b> , and <b>[Max frequency] (tFr)</b> must not exceed 100 Hz.<br><b>Failure to follow this instruction can result in equipment damage.</b>  |  |                     |                     |
| <b>SFr</b><br>  | <input type="checkbox"/> <b>[Switching freq.]</b> (1)  | According to rating | According to rating |
| Switching frequency setting.<br><b>Adjustment range:</b> This can vary between 1 and 16 kHz, but the minimum and maximum values, as well as the factory setting, can be limited in accordance with the type of drive (ATV71H or W), the rating and the configuration of the <b>[Sinus filter] (OFI)</b> and <b>[Motor surge limit] (SUL)</b> parameters, page 80.<br><br>If the value is less than 2 kHz, <b>[Current Limitation] (CLI)</b> and <b>[I Limit. 2 value] (CL2)</b> page 59 are limited to 1.36 In.<br>Adjustment with drive running:<br>- If the initial value is less than 2 kHz, it is not possible to increase it above 1.9 kHz while running.<br>- If the initial value is greater than or equal to 2 kHz, a minimum of 2 kHz must be maintained while running.<br>Adjustment with the drive stopped: No restrictions.<br><br> <b>Note:</b> In the event of excessive temperature rise, the drive will automatically reduce the switching frequency and reset it once the temperature returns to normal.<br><br> <b>Note:</b> If <b>[Motor control type] (Ctt)</b> page 69 = <b>[FVC] (FUC)</b> , we do not recommend setting the switching frequency to a value less than 2 kHz (in order to avoid speed instability). |  |                     |                     |
| <b>CAUTION</b>   |  |                     |                     |
| On ATV71●075N4 to U40N4, drives, if the RFI filters are disconnected (operation on an IT system), the drive's switching frequency must not exceed 4 kHz.<br><b>Failure to follow this instruction can result in equipment damage.</b>  |  |                     |                     |
| <b>CLI</b><br>  | <input type="checkbox"/> <b>[Current Limitation]</b> (1)   | 0 to 1.65 In (2)    | 1.5 In (2)          |
| Used to limit the motor current.<br>The adjustment range is limited to 1.36 In if <b>[Switching freq.] (SFr)</b> is less than 2 kHz.<br> <b>Note:</b> If the setting is less than 0.25 In, the drive may lock in <b>[Output Phase Loss] (OPF)</b> fault mode if this has been enabled (see page 217). If it is less than the no-load motor current, the limitation no longer has any effect.  |  |                     |                     |

(1) The parameter can also be accessed in the **[1.3 SETTINGS] (SEt-)** menu.

(2) In corresponds to the rated drive current indicated in the Installation Manual and on the drive nameplate.

 Parameter that can be modified during operation or when stopped.

## [1.4 MOTOR CONTROL] (drC-)

| Code  | Name/Description   | Adjustment range | Factory setting     |
|---|--|------------------|---------------------|
| <p><i>n r d</i></p> <p><i>n O</i></p> <p><i>Y E S</i></p> | <p><input type="checkbox"/> <b>[Noise reduction]</b></p> <p><input type="checkbox"/> <b>[No] (nO)</b>: Fixed frequency. Factory setting at and above 55 kW (75 HP) for ATV71●●●M3X and at and above 90 kW (120 HP) for ATV71●●●N4.</p> <p><input type="checkbox"/> <b>[Yes] (YES)</b>: Frequency with random modulation. Factory setting up to 45 kW (60 HP) for ATV71●●●M3X and up to 75 kW (100 HP) for the ATV71●●●N4.</p> <p>Random frequency modulation prevents any resonance, which may occur at a fixed frequency.</p>   |                  | According to rating |
| <p><i>S U L</i></p> <p><i>n O</i></p> <p><i>Y E S</i></p> | <p><input type="checkbox"/> <b>[Motor surge limit.]</b></p> <p>This function limits motor overvoltages and is useful in the following applications:</p> <ul style="list-style-type: none"> <li>- NEMA motors</li> <li>- Japanese motors</li> <li>- Spindle motors</li> <li>- Rewound motors</li> </ul> <p><input type="checkbox"/> <b>[No] (nO)</b> : Function inactive</p> <p><input type="checkbox"/> <b>[Yes] (YES)</b> : Function active</p> <p>This parameter is forced to <b>[No] (nO)</b> if <b>[Sinus filter] (OFI)</b> previous page = <b>[Yes] (YES)</b>.</p> <p>This parameter can remain = <b>[No] (nO)</b> for 230/400 V motors used at 230 V, or if the length of cable between the drive and the motor does not exceed:</p> <ul style="list-style-type: none"> <li>- 4 m with unshielded cables</li> <li>- 10 m with shielded cables</li> </ul> |                  | <b>[No] (nO)</b>    |
| <i>S O P</i>  | <p><input type="checkbox"/> <b>[Volt surge limit. opt]</b></p> <p>Optimization parameter for transient overvoltages at the motor terminals. Can be accessed if <b>[Motor surge limit.] (SUL)</b> = <b>[Yes] (YES)</b>.</p> <p>Set to 6, 8, or 10 μs, according to the following table.</p>   |                  | 10 μs               |

The value of the "SOP" parameter corresponds to the attenuation time of the cable used. It is defined to prevent the superimposition of voltage wave reflections resulting from long cable lengths. It limits overvoltages to twice the DC bus rated voltage.

The tables on the following page give examples of correspondence between the "SOP" parameter and the length of the cable between the drive and the motor. For longer cable lengths, a sinus filter or a dV/dt protection filter must be used.

- For motors in parallel, the sum of all the cable lengths must be taken into consideration. Compare the length given in the table row corresponding to the power for one motor with that corresponding to the total power, and select the shorter length. Example: Two 7.5 kW (10 HP) motors - take the lengths on the 15 kW (20 HP) table row, which are shorter than those on the 7.5 kW (10 HP) row, and divide by the number of motors to obtain the length per motor (with unshielded "GORSE" cable and SOP = 6, the result is  $40/2 = 20$  m maximum for each 7.5 kW (10 HP) motor).

In special cases (for example, different types of cable, different motor powers in parallel, different cable lengths in parallel, etc.), we recommend using an oscilloscope to check the overvoltage values obtained at the motor terminals.

To retain the overall drive performance, do not increase the SOP value unnecessarily.



## [1.4 MOTOR CONTROL] (drC-)



Tables giving the correspondence between the SOP parameter and the cable length, for 400 V line supply

| Altivar 71  | Motor |     | Cable cross-section |     | Maximum cable length in meters                 |          |          |   |          |          |
|-------------|-------|-----|---------------------|-----|--|----------|----------|---|----------|----------|
| Reference   | Power |     |                     |     | Unshielded "GORSE" cable<br>Type H07 RN-F 4Gxx |          |          | Shielded "GORSE" cable<br>Type GVCSTV-LS/LH |          |          |
|             | kW    | HP  | in mm <sup>2</sup>  | AWG | SOP = 10                                       | SOP = 8  | SOP = 6  | SOP = 10                                    | SOP = 8  | SOP = 6  |
| ATV71H075N4 | 0.75  | 1   | 1.5                 | 14  | 109.36 yd                                      | 76.55 yd | 49.21 yd | 114.83 yd                                   | 92.96 yd | 71.08 yd |
| ATV71HU15N4 | 1.5   | 2   | 1.5                 | 14  | 109.36 yd                                      | 76.55 yd | 49.21 yd | 114.83 yd                                   | 92.96 yd | 71.08 yd |
| ATV71HU22N4 | 2.2   | 3   | 1.5                 | 14  | 120.30 yd                                      | 71.08 yd | 49.21 yd | 114.83 yd                                   | 92.96 yd | 71.08 yd |
| ATV71HU30N4 | 3     | -   | 1.5                 | 14  | 120.30 yd                                      | 71.08 yd | 49.21 yd | 114.83 yd                                   | 92.96 yd | 71.08 yd |
| ATV71HU40N4 | 4     | 5   | 1.5                 | 14  | 120.30 yd                                      | 71.08 yd | 49.21 yd | 114.83 yd                                   | 92.96 yd | 71.08 yd |
| ATV71HU55N4 | 5.5   | 7.5 | 2.5                 | 14  | 131.23 yd                                      | 71.08 yd | 49.21 yd | 114.83 yd                                   | 92.96 yd | 71.08 yd |
| ATV71HU75N4 | 7.5   | 10  | 2.5                 | 14  | 131.23 yd                                      | 71.08 yd | 49.21 yd | 114.83 yd                                   | 92.96 yd | 71.08 yd |
| ATV71HD11N4 | 11    | 15  | 6                   | 10  | 125.77 yd                                      | 65.62 yd | 49.21 yd | 109.36 yd                                   | 82.02 yd | 60.15 yd |
| ATV71HD15N4 | 15    | 20  | 10                  | 8   | 114.83 yd                                      | 65.62 yd | 43.74 yd | 109.36 yd                                   | 76.55 yd | 54.68 yd |
| ATV71HD18N4 | 18.5  | 25  | 10                  | 8   | 125.77 yd                                      | 65.62 yd | 38.28 yd | 164.04 yd                                   | 82.02 yd | 54.68 yd |
| ATV71HD22N4 | 22    | 30  | 16                  | 6   | 164.04 yd                                      | 65.62 yd | 43.74 yd | 164.04 yd                                   | 76.55 yd | 54.68 yd |
| ATV71HD30N4 | 30    | 40  | 25                  | 4   | 164.04 yd                                      | 60.15 yd | 38.28 yd | 164.04 yd                                   | 76.55 yd | 54.68 yd |
| ATV71HD37N4 | 37    | 50  | 35                  | 5   | 218.72 yd                                      | 71.08 yd | 54.68 yd | 164.04 yd                                   | 76.55 yd | 54.68 yd |
| ATV71HD45N4 | 45    | 60  | 50                  | 0   | 218.72 yd                                      | 60.15 yd | 32.81 yd | 164.04 yd                                   | 65.62 yd | 43.74 yd |
| ATV71HD55N4 | 55    | 75  | 70                  | 2/0 | 218.72 yd                                      | 54.68 yd | 27.34 yd | 164.04 yd                                   | 60.15 yd | 32.81 yd |
| ATV71HD75N4 | 75    | 100 | 95                  | 4/0 | 218.72 yd                                      | 49.21 yd | 27.34 yd | 164.04 yd                                   | 60.15 yd | 32.81 yd |

| Altivar 71  | Motor |     | Cable cross-section |     | Maximum cable length in meters        |          |          |   |          |          |
|-------------|-------|-----|---------------------|-----|---------------------------------------|----------|----------|---|----------|----------|
| Reference   | Power |     |                     |     | Shielded "BELDEN" cable<br>Type 2950x |          |          | Shielded "PROTOFLEX" cable<br>Type EMV 2YSLCY-J |          |          |
|             | kW    | HP  | in mm <sup>2</sup>  | AWG | SOP = 10                              | SOP = 8  | SOP = 6  | SOP = 10  | SOP = 8  | SOP = 6  |
| ATV71H075N4 | 0.75  | 1   | 1.5                 | 14  | 54.68 yd                              | 43.74 yd | 32.81 yd |   |          |          |
| ATV71HU15N4 | 1.5   | 2   | 1.5                 | 14  | 54.68 yd                              | 43.74 yd | 32.81 yd |   |          |          |
| ATV71HU22N4 | 2.2   | 3   | 1.5                 | 14  | 54.68 yd                              | 43.74 yd | 32.81 yd |   |          |          |
| ATV71HU30N4 | 3     | -   | 1.5                 | 14  | 54.68 yd                              | 43.74 yd | 32.81 yd |   |          |          |
| ATV71HU40N4 | 4     | 5   | 1.5                 | 14  | 54.68 yd                              | 43.74 yd | 32.81 yd |   |          |          |
| ATV71HU55N4 | 5.5   | 7.5 | 2.5                 | 14  | 54.68 yd                              | 43.74 yd | 32.81 yd |   |          |          |
| ATV71HU75N4 | 7.5   | 10  | 2.5                 | 14  | 54.68 yd                              | 43.74 yd | 32.81 yd |   |          |          |
| ATV71HD11N4 | 11    | 15  | 6                   | 10  | 54.68 yd                              | 43.74 yd | 32.81 yd |   |          |          |
| ATV71HD15N4 | 15    | 20  | 10                  | 8   | 54.68 yd                              | 43.74 yd | 32.81 yd |   |          |          |
| ATV71HD18N4 | 18.5  | 25  | 10                  | 8   | 54.68 yd                              | 43.74 yd | 32.81 yd |   |          |          |
| ATV71HD22N4 | 22    | 30  | 16                  | 6   |                                       |          |          | 82.02 yd  | 43.74 yd | 27.34 yd |
| ATV71HD30N4 | 30    | 40  | 25                  | 4   |                                       |          |          | 82.02 yd  | 43.74 yd | 27.34 yd |
| ATV71HD37N4 | 37    | 50  | 35                  | 5   |                                       |          |          | 82.02 yd  | 43.74 yd | 27.34 yd |
| ATV71HD45N4 | 45    | 60  | 50                  | 0   |                                       |          |          | 82.02 yd  | 43.74 yd | 27.34 yd |
| ATV71HD55N4 | 55    | 75  | 70                  | 2/0 |                                       |          |          | 82.02 yd  | 32.81 yd | 16.40 yd |
| ATV71HD75N4 | 75    | 100 | 95                  | 4/0 |                                       |          |          | 82.02 yd  | 32.81 yd | 16.40 yd |

For 230/400 V motors used at 230 V, the [Motor surge limit.] (SUL) parameter can remain = [No] (nO).

# [1.4 MOTOR CONTROL] (drC-)

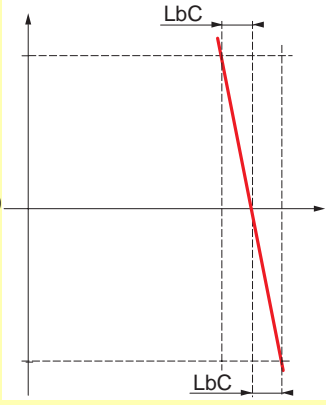
| Code  | Name/Description  | Adjustment range | Factory setting                   |
|---|---|------------------|-----------------------------------|
| <b>Ubr</b><br>   | <input type="checkbox"/> <b>[Braking level]</b><br><br>DC bus voltage threshold above which the braking transistor cuts in to limit this voltage.<br>ATV71●●●●M3●: factory setting 395 V.<br>ATV71●●●●N4: factory setting 785 V.<br>The adjustment range depends on the voltage rating of the drive and the <b>[Mains voltage] (UrES)</b> parameter, page 221.  |                  | According to drive voltage rating |
| <b>bbA</b><br><br><b>nO</b><br><b>YES</b>   | <input type="checkbox"/> <b>[Braking balance]</b><br><br><input type="checkbox"/> <b>[No] (nO)</b> : Function inactive<br><input type="checkbox"/> <b>[Yes] (YES)</b> : Function active, to be used on drives connected in parallel via their DC bus. Used to balance the braking power between the drives. The <b>[Braking level] (Ubr)</b> parameter must be set to the same value on the various drives.<br>The value <b>[Yes] (YES)</b> is possible only if <b>[Dec ramp adapt.] (brA) = [No] (nO)</b> (see page 136)   |                  | <b>[No] (nO)</b>                  |
| <b>LbA</b><br><br><b>nO</b><br><b>YES</b>   | <input type="checkbox"/> <b>[Load sharing]</b><br><br>When 2 motors are connected mechanically and therefore at the same speed, and each is controlled by a drive, this function can be used to improve torque distribution between the two motors. To do this, it varies the speed based on the torque.<br><input type="checkbox"/> <b>[No] (nO)</b> : Function inactive<br><input type="checkbox"/> <b>[Yes] (YES)</b> : Function active<br>The parameter can only be accessed if <b>[Motor control type] (Ctt)</b> page 69 is not <b>[V/F 2pts] (UF2)</b> or <b>[V/F 5pts] (UF5)</b> . |                  | <b>[No] (nO)</b>                  |
| <b>LbC</b><br> | <input type="checkbox"/> <b>[Load correction]</b> (1)<br><br>Rated correction in Hz.<br>The parameter can be accessed if <b>[Load sharing] (LbA) = [Yes] (YES)</b><br><br><div style="display: flex; align-items: center;"> <div style="margin-right: 10px;">Torque</div>  </div>  | 0 to 1000 Hz     | 0                                 |

(1) The parameter can also be accessed in the **[1.3 SETTINGS] (SEt-)** menu.

 Parameter that can be modified during operation or when stopped.

## [1.4 MOTOR CONTROL] (drC-)

### Load sharing, parameters that can be accessed at expert level

#### Principle

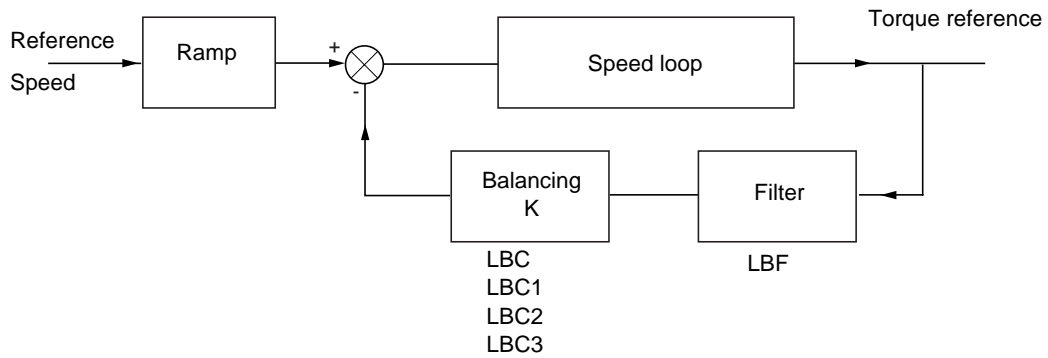

The load sharing factor  $K$  is determined by the torque and speed, with two factors  $K1$  and  $K2$  ( $K = K1 \times K2$ ).

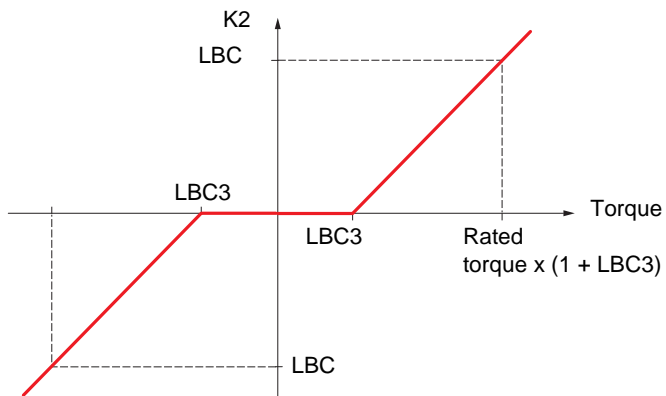
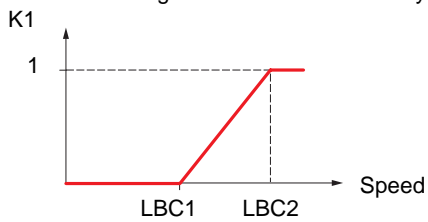

## [1.4 MOTOR CONTROL] (drC-)

| Code        | Name/Description  | Adjustment range                             | Factory setting |
|-------------|---|--|-----------------|
| LbC1<br>( ) | <input type="checkbox"/> <b>[Correction min spd]</b><br>The parameter can be accessed if [Load sharing] (LbA) = [Yes] (YES)<br>Minimum speed for load correction in Hz. Below this threshold, no corrections are made. Used to prevent correction at very low speed if this would hamper rotation of the motor.       | 0 to 999.9 Hz                                | 0               |
| LbC2<br>( ) | <input type="checkbox"/> <b>[Correction max spd]</b><br>The parameter can be accessed if [Load sharing] (LbA) = [Yes] (YES)<br>Speed threshold in Hz above which maximum load correction is applied.  | [Correction min spd] (LbC1) + 0.1 at 1000 Hz | 0,1             |
| LbC3<br>( ) | <input type="checkbox"/> <b>[Torque offset]</b><br>The parameter can be accessed if [Load sharing] (LbA) = [Yes] (YES)<br>Minimum torque for load correction as a % of the rated torque. Below this threshold, no corrections are made. Used to avoid torque instabilities when the torque direction is not constant. | 0 to 300%                                    | 0%              |
| LbF<br>( )  | <input type="checkbox"/> <b>[Sharing filter]</b><br>The parameter can be accessed if [Load sharing] (LbA) = [Yes] (YES)<br>Time constant (filter) for correction in ms. Used in the event of flexible mechanical coupling in order to avoid instabilities.  | 100 ms to 20 s                               | 100 ms          |

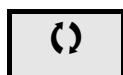

Parameter that can be modified during operation or when stopped.

# [1.5 INPUTS / OUTPUTS CFG] (I-O-)

With graphic display terminal:

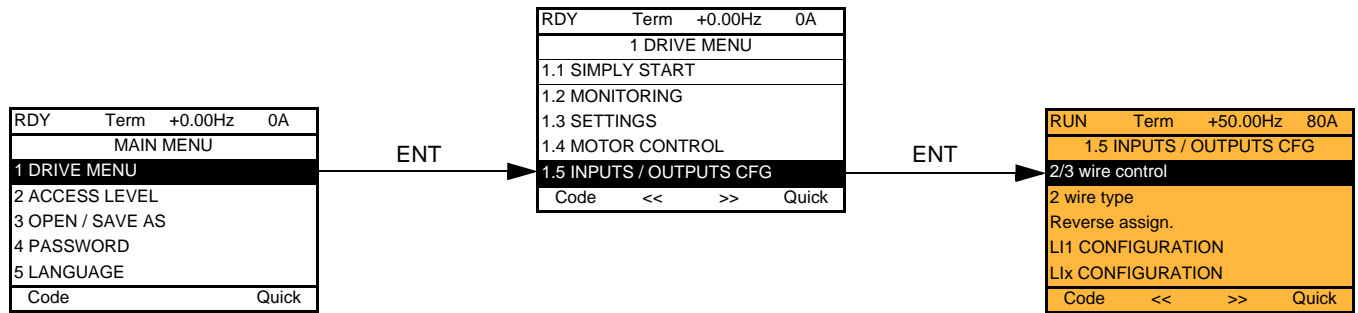

With integrated display terminal:

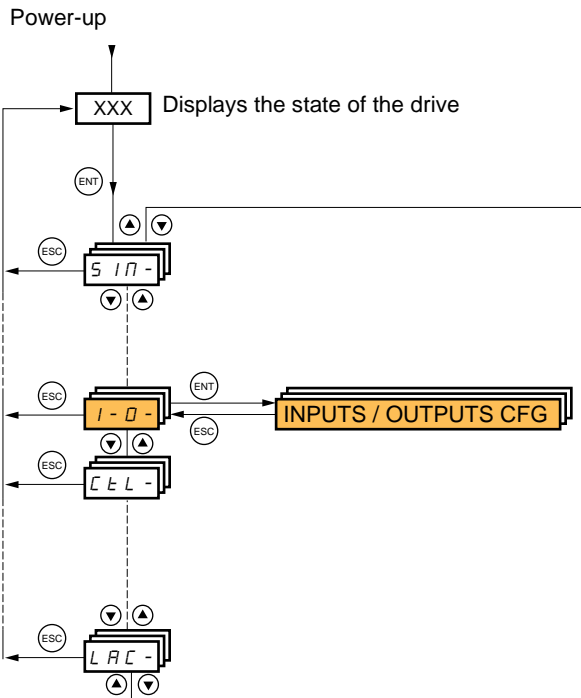

# [1.5 INPUTS / OUTPUTS CFG] (I-O-)

The parameters in the [1.5 INPUTS / OUTPUTS CFG] (I-O-) menu can only be modified when the drive is stopped and no run command is present.

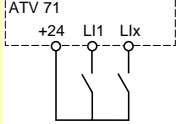
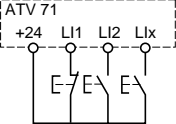
| Code  | Name/Description   | Adjustment range | Factory setting    |
|---|--|------------------|--------------------|
| <p><b>tCC</b></p> <p>2C<br/>3C</p>  | <p><input type="checkbox"/> <b>[2/3 wire control]</b></p> <p><input type="checkbox"/> [2 wire] (2C)<br/><input type="checkbox"/> [3 wire] (3C)</p> <p>2-wire control: This is the input state (0 or 1) or edge (0 to 1 or 1 to 0), which controls running or stopping.</p> <p>Example of "source" wiring:</p>  <p>LI1: forward<br/>LIx: reverse</p> <p>3-wire control (pulse commands): A "forward" or "reverse" pulse is sufficient to command starting, a "stop" pulse is sufficient to command stopping.</p> <p>Example of "source" wiring:</p>  <p>LI1: stop<br/>LI2: forward<br/>LIx: reverse</p>   |                  | [2 wire] (2C)      |
| <p><b>⚠ WARNING</b></p> <p><b>UNINTENDED EQUIPMENT OPERATION</b></p> <p>To change the assignment of [2/3 wire control] (tCC) press and hold down the "ENT" key for 2 s. It causes the following functions to return to factory setting: [2 wire type] (tCt) and [Reverse assign.] (rrS) below, and all functions which assign logic inputs and analog inputs. The macro configuration selected will also be reset if it has been customized (loss of custom settings). It is advisable to configure this parameter before configuring the [1.6 COMMAND] (CtL-) and [1.7 APPLICATION FUNCT.] (FUn-) menus. Check that this change is compatible with the wiring diagram used. <b>Failure to follow these instructions can result in death or serious injury.</b></p> |  |                  |                    |
| <p><b>tCt</b></p> <p>LEL<br/>t r n<br/>PFO</p>  | <p><input type="checkbox"/> <b>[2 wire type]</b></p> <p><input type="checkbox"/> [Level] (LEL): State 0 or 1 is taken into account for run (1) or stop (0).<br/><input type="checkbox"/> [Transition] (trn): A change of state (transition or edge) is necessary to initiate operation, in order to prevent accidental restarts after a break in the power supply.<br/><input type="checkbox"/> [Fwd priority] (PFO): State 0 or 1 is taken into account for run or stop, but the "forward" input always takes priority over the "reverse" input.</p>  |                  | [Transition] (trn) |
| <p><b>rrS</b></p> <p>nO<br/>LI1<br/>-<br/>-<br/>C101<br/>-<br/>-<br/>-<br/>Cd00<br/>-</p>   | <p><input type="checkbox"/> <b>[Reverse assign.]</b></p> <p><input type="checkbox"/> [No] (nO): Not assigned<br/><input type="checkbox"/> [LI1] (LI1) to [LI6] (LI6)<br/><input type="checkbox"/> [LI7] (LI7) to [LI10] (LI10): If VW3A3201 logic I/O card has been inserted<br/><input type="checkbox"/> [LI11] (LI11) to [LI14] (LI14): If VW3A3202 extended I/O card has been inserted<br/><input type="checkbox"/> [C101] (C101) to [C115] (C115): With integrated Modbus in [I/O profile] (IO)<br/><input type="checkbox"/> [C201] (C201) to [C215] (C215): With integrated CANopen in [I/O profile] (IO)<br/><input type="checkbox"/> [C301] (C301) to [C315] (C315): With a communication card in [I/O profile] (IO)<br/><input type="checkbox"/> [C401] (C401) to [C415] (C415): With a Controller Inside card in [I/O profile] (IO)<br/><input type="checkbox"/> [CD00] (Cd00) to [CD13] (Cd13): In [I/O profile] (IO) can be switched with possible logic inputs<br/><input type="checkbox"/> [CD14] (Cd14) to [CD15] (Cd15): In [I/O profile] (IO) can be switched without logic inputs</p> <p>Assignment of the reverse direction command.</p> |                  | [LI2] (LI2)        |

## [1.5 INPUTS / OUTPUTS CFG] (I-O-)

| Code   | Name/Description  | Adjustment range | Factory setting |
|--|---|------------------|-----------------|
| L 1 -  | <b>■ [LI1 CONFIGURATION]</b>  |                  |                 |
| L 1 A  | <input type="checkbox"/> <b>[LI1 assignment]</b><br>Read-only parameter, cannot be configured.<br>It displays all the functions that are assigned to input LI1 in order to check for multiple assignments.  |                  |                 |
| L 1 d  | <input type="checkbox"/> <b>[LI1 On Delay]</b><br>This parameter is used to take account of the change of the logic input to state 1 with a delay that can be adjusted between 0 and 200 milliseconds, in order to filter out possible interference. The change to state 0 is taken into account without delay. | 0 to 200 ms      | 0               |
| <div style="border: 1px solid black; padding: 5px; margin: 10px auto; width: 80%;">  <b>WARNING</b><br/> <b>UNINTENDED EQUIPMENT OPERATION</b><br/>           Check that the delay set does not pose a risk or lead to undesired operation.<br/>           The relative order in which these inputs are taken into account may be modified according to the delay values of the various logic inputs, and thus lead to unintended operation.<br/> <b>Failure to follow these instructions can result in death or serious injury.</b> </div> |   |                  |                 |
| L - -  | <b>■ [Lix CONFIGURATION]</b>  |                  |                 |
|  | All the logic inputs available on the drive are processed as in the example for LI1 above, up to LI6, LI10 or LI14, depending on whether or not option cards have been inserted.  |                  |                 |

## Configuration of analog inputs and Pulse input

The minimum and maximum input values (in volts, mA, etc.) are converted to % in order to adapt the references to the application.

### Minimum and maximum input values:

The minimum value corresponds to a reference of 0% and the maximum value to a reference of 100%. The minimum value may be greater than the maximum value:

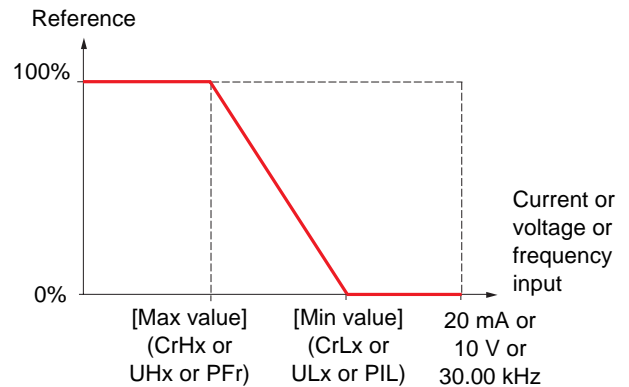
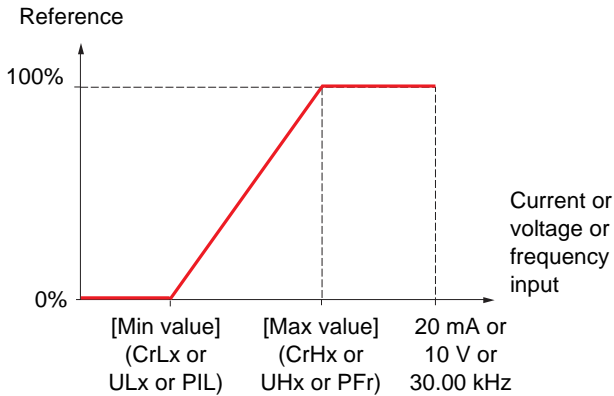

For +/- bidirectional inputs, the min. and max. are relative to the absolute value, for example, +/- 2 to 8 V.

### Negative min. value of Pulse input:

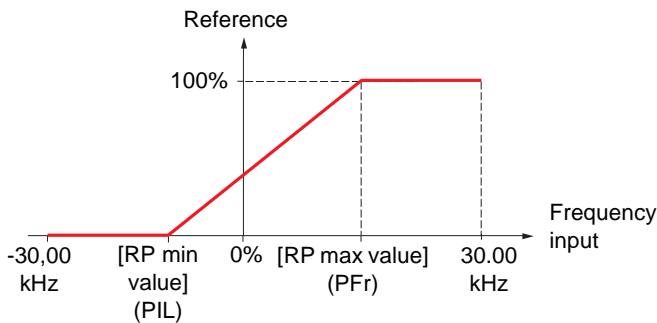

### Range (output values): For analog inputs only

This parameter is used to configure the reference range to [0% → 100%] or [-100% → +100%] in order to obtain a bidirectional output from a unidirectional input.

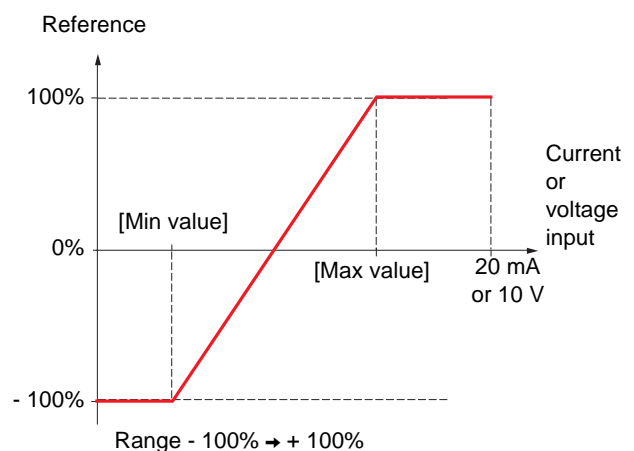
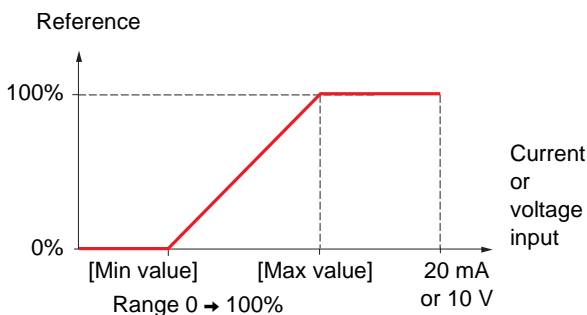

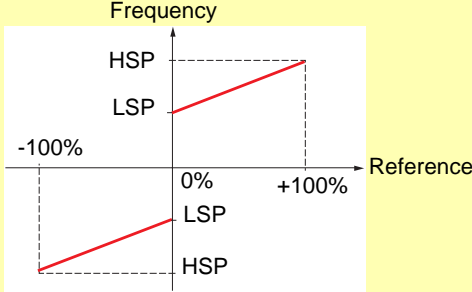
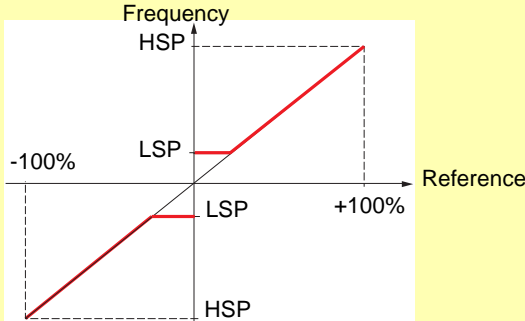
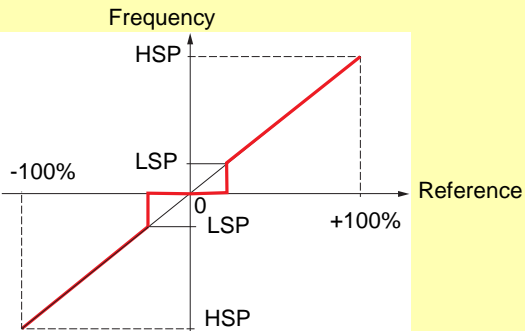
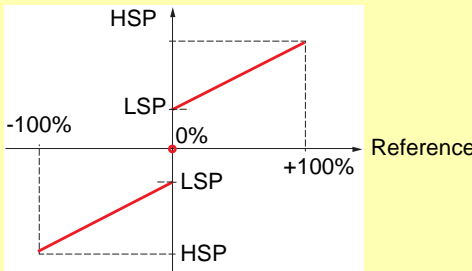

# [1.5 INPUTS / OUTPUTS CFG] (I-O-)

| Code  | Name/Description   | Adjustment range   | Factory setting         |
|---|--|--|-------------------------|
| <b>bSP</b>  | <input type="checkbox"/> <b>[Reference template]</b>   |  | <b>[Standard] (bSd)</b> |
| <b>bSd</b>  | <input type="checkbox"/> <b>[Standard] (bSd)</b><br>      | At zero reference the frequency = LSP  |                         |
| <b>bLS</b>  | <input type="checkbox"/> <b>[Pedestal] (bLS)</b><br>     | At reference = 0 to LSP the frequency = LSP  |                         |
| <b>bnS</b>  | <input type="checkbox"/> <b>[Deadband] (bnS)</b><br>    | At reference = 0 to LSP the frequency = 0  |                         |
| <b>bnS0</b>   | <input type="checkbox"/> <b>[Deadband 0] (bnS0)</b><br> | <p>This operation is the same as <b>[Standard] (bSd)</b>, except that in the following cases at zero reference, the frequency = 0:</p> <ul style="list-style-type: none"> <li>• The signal is less than [Min value], which is greater than 0 (example 1 V on a 2 - 10 V input)</li> <li>• The signal is greater than [Min value], which is greater than [Max value] (example 11 V on a 10 - 0 V input).</li> </ul> <p>If the input range is configured as "bidirectional", operation remains identical to <b>[Standard] (bSd)</b>.</p> |                         |
| <p><b>This parameter defines how the speed reference is taken into account, for analog inputs and Pulse input only.</b> In the case of the PID regulator, this is the PID output reference.<br/> The limits are set by the <b>[Low speed] (LSP)</b> and <b>[High speed] (HSP)</b> parameters, page 42</p> |  |  |                         |

# [1.5 INPUTS / OUTPUTS CFG] (I-O-)

## Delinearization: For analog inputs only

The input can be delinearized by configuring an intermediate point on the input/output curve of this input:

For range 0 → 100%

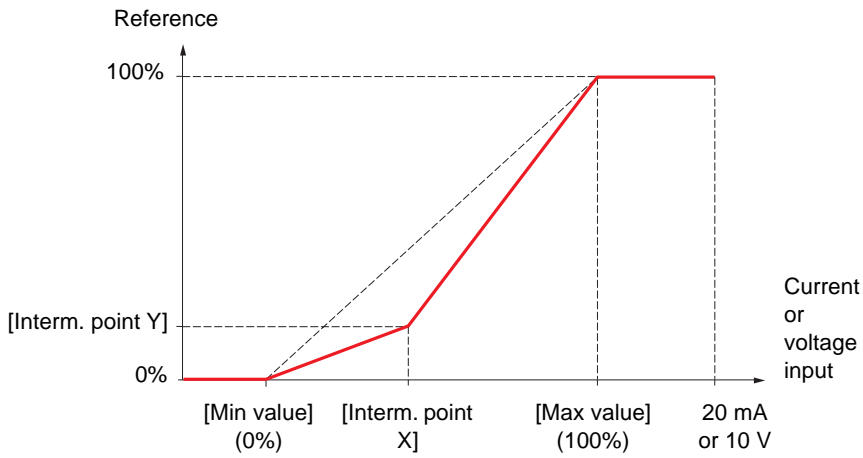

**Note:** For [Interm. point X], 0% corresponds to [Min value] and 100% to [Max value]

For range -100% → 100%

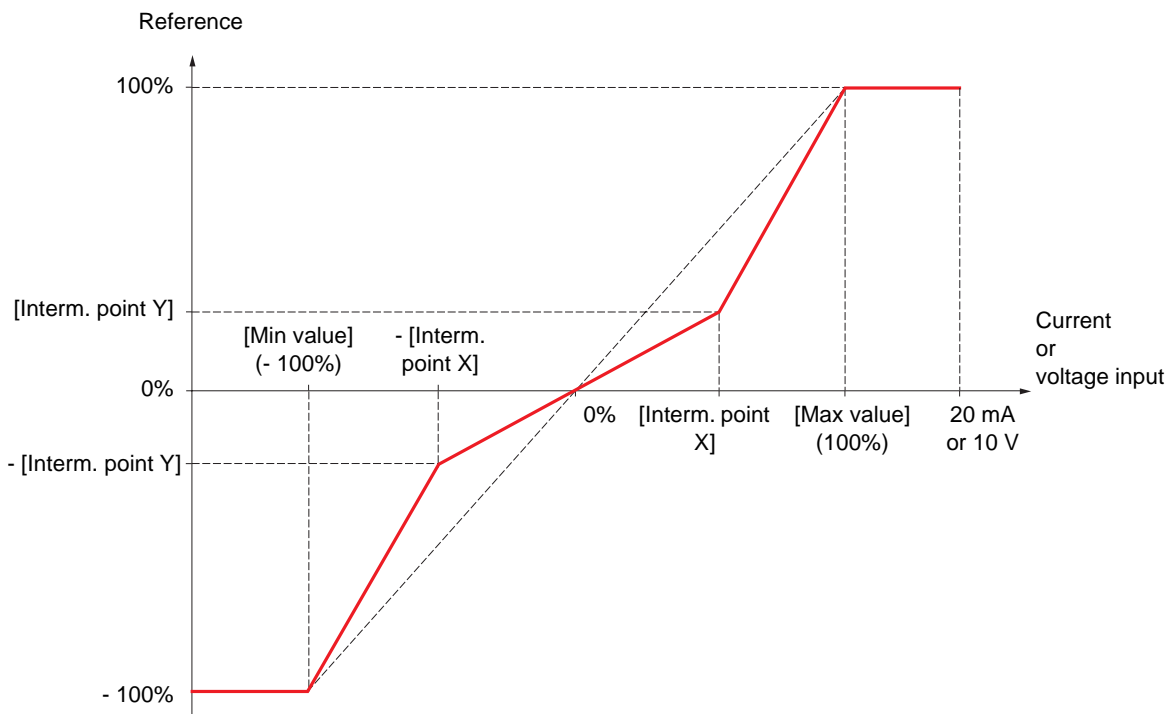

## [1.5 INPUTS / OUTPUTS CFG] (I-O-)

| Code                                     | Name/Description  | Adjustment range | Factory setting        |
|--|---|------------------|------------------------|
| <b>A11 -</b>                             | <b>■ [A1 CONFIGURATION]</b>   |                  |                        |
| <b>A11A</b>                              | <input type="checkbox"/> <b>[A1 assignment]</b><br>Read-only parameter, cannot be configured.<br>It displays all the functions associated with input A11 in order to check, for example, for compatibility problems.  |                  |                        |
| <b>A11E</b><br><b>10U</b><br><b>n10U</b> | <input type="checkbox"/> <b>[A1 Type]</b><br><input type="checkbox"/> <b>[Voltage] (10U)</b> : Positive voltage input (negative values are interpreted as zero: the input is unidirectional).<br><input type="checkbox"/> <b>[Voltage +/-] (n10U)</b> : Positive and negative voltage input (the input is bidirectional). |                  | <b>[Voltage] (10U)</b> |
| <b>UIL1</b>                              | <input type="checkbox"/> <b>[A11 min value]</b>   | 0 to 10.0 V      | 0 V                    |
| <b>UIH1</b>                              | <input type="checkbox"/> <b>[A11 max value]</b>   | 0 to 10.0 V      | 10.0 V                 |
| <b>A11F</b>                              | <input type="checkbox"/> <b>[A11 filter]</b><br>Interference filtering.   | 0 to 10.00 s     | 0 s                    |
| <b>A11E</b>                              | <input type="checkbox"/> <b>[A11 Interm. point X]</b><br>Input delinearization point coordinate.<br><ul style="list-style-type: none"> <li>• 0% corresponds to <b>[A11 min value] (UIL1)</b>.</li> <li>• 100% corresponds to <b>[A11 max value] (UIH1)</b>.</li> </ul>  | 0 to 100%        | 0%                     |
| <b>A11S</b>                              | <input type="checkbox"/> <b>[A11 Interm. point Y]</b><br>Output delinearization point coordinate (frequency reference).   | 0 to 100%        | 0%                     |

# [1.5 INPUTS / OUTPUTS CFG] (I-O-)

| Code                                     | Name/Description  | Adjustment range | Factory setting         |
|--|---|------------------|-------------------------|
| <b>A 12 -</b>                            | <b>■ [AI2 CONFIGURATION]</b>  |                  |                         |
| <b>A 12A</b>                             | <input type="checkbox"/> <b>[AI2 assignment]</b><br>Read-only parameter, cannot be configured.<br>It displays all the functions associated with input AI2 in order to check, for example, for compatibility problems.   |                  |                         |
| <b>A 12E</b><br><b>10U</b><br><b>0A</b>  | <input type="checkbox"/> <b>[AI2 Type]</b><br><input type="checkbox"/> <b>[Voltage] (10U)</b> : Voltage input<br><input type="checkbox"/> <b>[Current] (0A)</b> : Current input   |                  | <b>[Current] (0 A)</b>  |
| <b>CrL2</b>                              | <input type="checkbox"/> <b>[AI2 min value]</b><br>The parameter can be accessed if <b>[AI2 Type] (AI2t) = [Current] (0 A)</b>  | 0 to 20.0 mA     | 0 mA                    |
| <b>U 1L2</b>                             | <input type="checkbox"/> <b>[AI2 min value]</b><br>The parameter can be accessed if <b>[AI2 Type] (AI2t) = [Voltage] (10U)</b>  | 0 to 10.0 V      | 0 V                     |
| <b>CrH2</b>                              | <input type="checkbox"/> <b>[AI2 max. value]</b><br>The parameter can be accessed if <b>[AI2 Type] (AI2t) = [Current] (0 A)</b>   | 0 to 20.0 mA     | 20.0 mA                 |
| <b>U 1H2</b>                             | <input type="checkbox"/> <b>[AI2 max. value]</b><br>The parameter can be accessed if <b>[AI2 Type] (AI2t) = [Voltage] (10U)</b>   | 0 to 10.0 V      | 10.0 V                  |
| <b>A 12F</b>                             | <input type="checkbox"/> <b>[AI2 filter]</b><br>Interference filtering.   | 0 to 10.00 s     | 0 s                     |
| <b>A 12L</b><br><b>POS</b><br><b>nEG</b> | <input type="checkbox"/> <b>[AI2 range]</b><br><input type="checkbox"/> <b>[0 - 100%] (POS)</b> : Unidirectional input<br><input type="checkbox"/> <b>[+/- 100%] (nEG)</b> : Bidirectional input<br>Example: On a 0/10 V input<br>- 0 V corresponds to reference -100%<br>- 5 V corresponds to reference 0%<br>- 10 V corresponds to reference + 100% |                  | <b>[0 - 100%] (POS)</b> |
| <b>A 12E</b>                             | <input type="checkbox"/> <b>[AI2 Interm. point X]</b><br>Input delinearization point coordinate.<br>• 0% corresponds to <b>[Min value]</b> if the range is 0 → 100%.<br>• 0% corresponds to $\frac{[\text{Max value}] + [\text{Min value}]}{2}$ if the range is -100% → + 100%.<br>• 100% corresponds to <b>[Max value]</b> .                         | 0 to 100%        | 0%                      |
| <b>A 12S</b>                             | <input type="checkbox"/> <b>[AI2 Interm. point Y]</b><br>Output delinearization point coordinate (frequency reference).   | 0 to 100%        | 0%                      |

# [1.5 INPUTS / OUTPUTS CFG] (I-O-)

| Code                                     | Name/Description  | Adjustment range | Factory setting        |
|--|---|------------------|------------------------|
| <b>A I3 -</b>                            | <b>■ [AI3 CONFIGURATION]</b><br>Can be accessed if a VW3A3202 option card has been inserted   |                  |                        |
| <b>A I3A</b>                             | <input type="checkbox"/> <b>[AI3 assignment]</b><br>Read-only parameter, cannot be configured.<br>It displays all the functions associated with input AI3 in order to check, for example, for compatibility problems.   |                  |                        |
| <b>A I3E</b>                             | <input type="checkbox"/> <b>[AI3 Type]</b><br>Read-only parameter, cannot be configured.<br><input type="checkbox"/> <b>[Current] (0 A)</b> : Current input   |                  | <b>[Current] (0 A)</b> |
| <b>CrL3</b>                              | <input type="checkbox"/> <b>[AI3 min. value]</b>  | 0 to 20.0 mA     | 0 mA                   |
| <b>CrH3</b>                              | <input type="checkbox"/> <b>[AI3 max. value]</b>  | 0 to 20.0 mA     | 20.0 mA                |
| <b>A I3F</b>                             | <input type="checkbox"/> <b>[AI3 filter]</b><br>Interference filtering.   | 0 to 10.00 s     | 0 s                    |
| <b>A I3L</b><br><b>POS</b><br><b>nEG</b> | <input type="checkbox"/> <b>[AI3 range]</b><br><input type="checkbox"/> <b>[0 - 100%] (POS)</b> : Unidirectional input<br><input type="checkbox"/> <b>[+/- 100%] (nEG)</b> : Bidirectional input<br>Example: On a 4 - 20 mA input<br>- 4 mA corresponds to reference -100%<br>- 12 mA corresponds to reference 0%<br>- 20 mA corresponds to reference + 100%<br>Since AI3 is, in physical terms, a bidirectional input, the <b>[+/- 100%] (nEG)</b> configuration must only be used if the signal applied is unidirectional. A bidirectional signal is not compatible with a bidirectional configuration. |                  |                        |
| <b>A I3E</b>                             | <input type="checkbox"/> <b>[AI3 Interm. point X]</b><br>Input delinearization point coordinate.<br><ul style="list-style-type: none"> <li>0% corresponds to <b>[Min value] (CrL3)</b> if the range is 0 → 100%.</li> <li>0% corresponds to <math>\frac{\text{[AI3 max. value] (CrH3)} - \text{[AI3 min. value] (CrL3)}}{2}</math> if the range is -100% → +100%.</li> <li>100% corresponds to <b>[AI3 max. value] (CrH3)</b>.</li> </ul>   | 0 to 100%        | 0%                     |
| <b>A I3S</b>                             | <input type="checkbox"/> <b>[AI3 Interm. point Y]</b><br>Output delinearization point coordinate (frequency reference).   | 0 to 100%        | 0%                     |

## [1.5 INPUTS / OUTPUTS CFG] (I-O-)

| Code   | Name/Description  | Adjustment range | Factory setting         |
|--|---|------------------|-------------------------|
| <b>A 14 -</b>                                | <b>■ [AI4 CONFIGURATION]</b><br>Can be accessed if a VW3A3202 option card has been inserted   |                  |                         |
| <b>A 14A</b>                                 | <input type="checkbox"/> <b>[AI4 assignment]</b><br>Read-only parameter, cannot be configured.<br>It displays all the functions associated with input AI4 in order to check, for example, for compatibility problems.   |                  |                         |
| <b>A 14E</b><br><br><b>10U</b><br><b>0A</b>  | <input type="checkbox"/> <b>[AI4 Type]</b><br><input type="checkbox"/> <b>[Voltage] (10U)</b> : Voltage input<br><input type="checkbox"/> <b>[Current] (0A)</b> : Current input   |                  | <b>[Voltage] (10U)</b>  |
| <b>C r L 4</b>                               | <input type="checkbox"/> <b>[AI4 min value]</b><br>The parameter can be accessed if <b>[AI4 Type] (AI4t) = [Current] (0A)</b>   | 0 to 20.0 mA     | 0 mA                    |
| <b>U I L 4</b>                               | <input type="checkbox"/> <b>[AI4 min value]</b><br>The parameter can be accessed if <b>[AI4 Type] (AI4t) = [Voltage] (10U)</b>  | 0 to 10.0 V      | 0 V                     |
| <b>C r H 4</b>                               | <input type="checkbox"/> <b>[AI4 max value]</b><br>The parameter can be accessed if <b>[AI4 Type] (AI4t) = [Current] (0A)</b>   | 0 to 20.0 mA     | 20.0 mA                 |
| <b>U I H 4</b>                               | <input type="checkbox"/> <b>[AI4 max value]</b><br>The parameter can be accessed if <b>[AI4 Type] (AI4t) = [Voltage] (10U)</b>  | 0 to 10.0 V      | 10.0 V                  |
| <b>A 14F</b>                                 | <input type="checkbox"/> <b>[AI4 filter]</b><br>Interference filtering.   | 0 to 10.00 s     | 0 s                     |
| <b>A 14L</b><br><br><b>POS</b><br><b>nEG</b> | <input type="checkbox"/> <b>[AI4 range]</b><br><input type="checkbox"/> <b>[0 - 100%] (POS)</b> : Unidirectional input<br><input type="checkbox"/> <b>[+/- 100%] (nEG)</b> : Bidirectional input<br>Example: On a 0/10 V input<br>- 0 V corresponds to reference -100%<br>- 5 V corresponds to reference 0%<br>- 10 V corresponds to reference + 100% |                  | <b>[0 - 100%] (POS)</b> |
| <b>A 14E</b>                                 | <input type="checkbox"/> <b>[AI4 Interm.point X]</b><br>Input delinearization point coordinate.<br>• 0% corresponds to <b>[Min value]</b> if the range is 0 → 100%.<br>• 0% corresponds to $\frac{[\text{Max value}] + [\text{Min value}]}{2}$ if the range is -100% → + 100%.<br>• 100% corresponds to <b>[Max value]</b> .                          | 0 to 100%        | 0%                      |
| <b>A 14S</b>                                 | <input type="checkbox"/> <b>[AI4 Interm.point Y]</b><br>Output delinearization point coordinate (frequency reference).  | 0 to 100%        | 0%                      |

# [1.5 INPUTS / OUTPUTS CFG] (I-O-)

| Code  | Name/Description   | Adjustment range | Factory setting         |
|---|--|------------------|-------------------------|
| <p><i>AU I-</i></p> <p><i>A I C I</i></p> <p><i>n O</i></p> <p><i>M d b</i></p> <p><i>C A n</i></p> <p><i>n E t</i></p> <p><i>A P P</i></p> | <p><b>■ [VIRTUAL AI1]</b></p> <p><input type="checkbox"/> <b>[AI net. channel]</b></p> <p>Virtual input.<br/>This parameter can also be accessed in the <b>[PID REGULATOR] (Pid-)</b> submenu page <b>173</b>.<br/><b>[No] (nO)</b>: Not assigned (in this case, the virtual input does not appear in the analog input assignment parameters for the functions)</p> <ul style="list-style-type: none"> <li><input type="checkbox"/> <b>[Modbus] (Mdb)</b>: Integrated Modbus</li> <li><input type="checkbox"/> <b>[CANopen] (CAN)</b>: Integrated CANopen</li> <li><input type="checkbox"/> <b>[Com. card] (nEt)</b>: Communication card (if inserted)</li> <li><input type="checkbox"/> <b>[C.Insid. card] (APP)</b>: Controller Inside card (if inserted)</li> </ul> <p>Scale: the value 8192 transmitted by this input is equivalent to 10 V on a 10 V input.</p> <div style="border: 1px solid black; padding: 5px; text-align: center;"> <p> <b>WARNING</b></p> <p><b>UNINTENDED EQUIPMENT OPERATION</b></p> <p>If the equipment switches to forced local mode (see page <b>237</b>), the virtual input remains fixed at the last value transmitted.<br/>Do not use the virtual input and forced local mode in the same configuration.<br/><b>Failure to follow these instructions can result in death or serious injury.</b></p> </div> |                  | <p><b>[No] (nO)</b></p> |

## [1.5 INPUTS / OUTPUTS CFG] (I-O-)

| Code         | Name/Description  | Adjustment range     | Factory setting |
|--------------|---|----------------------|-----------------|
| <i>PL I-</i> | <b>■ [RP CONFIGURATION]</b><br>Can be accessed if a VW3A3202 option card has been inserted  |                      |                 |
| <i>P I R</i> | <input type="checkbox"/> <b>[RP assignment]</b><br>Read-only parameter, cannot be configured.<br>It displays all the functions associated with the Pulse In input in order to check, for example, for compatibility problems. |                      |                 |
| <i>P I L</i> | <input type="checkbox"/> <b>[RP min value]</b><br>Frequency corresponding to the minimum speed  | - 30.00 to 30.00 kHz | 0               |
| <i>P F r</i> | <input type="checkbox"/> <b>[RP max value]</b><br>Frequency corresponding to the maximum speed  | 0 to 30.00 kHz       | 30.00 kHz       |
| <i>P F I</i> | <input type="checkbox"/> <b>[RP filter]</b><br>Interference filtering.  | 0 to 1000 ms         | 0               |



## [1.5 INPUTS / OUTPUTS CFG] (I-O-)

### Configuration of the encoder input serving as a reference, with a frequency generator

This reference is not signed, therefore the directions of operation must be given via the control channel (logic inputs, for example).

#### Minimum and maximum values (input values):

The minimum value corresponds to a minimum reference of 0% and the maximum value to a maximum reference of 100%. The minimum value may be greater than the maximum value. It may also be negative.

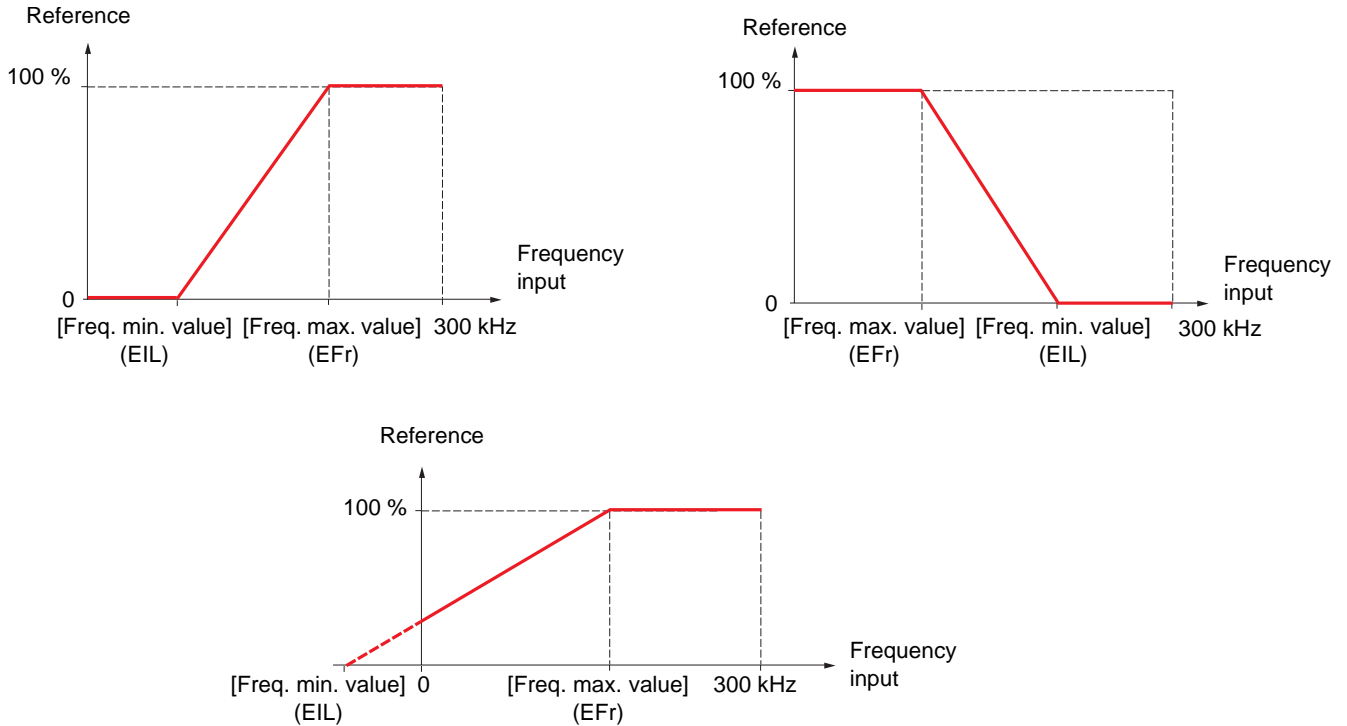

A reference can be obtained at zero frequency by assigning a negative value to the minimum value.

# [1.5 INPUTS / OUTPUTS CFG] (I-O-)

The encoder configuration can also be accessed in the [1.4 MOTOR CONTROL] (drC-) menu.

| Code                   | Name/Description   | Adjustment range | Factory setting |
|------------------------|--|------------------|-----------------|
| <b>IE n -</b>          | <b>■ [ENCODER CONFIGURATION]</b><br>The encoder parameters can only be accessed if the encoder card has been inserted, and the available selections will depend on the type of encoder card used.  |                  |                 |
| <b>EnS</b>             | <b>□ [Encoder type]</b><br><br>The parameter can be accessed if an encoder card has been inserted. To be configured in accordance with the type of encoder used.   |                  | [AABB] (AAbb)   |
| nO<br>AA bb<br>Ab<br>A | <input type="checkbox"/> [----] (nO): Card missing.<br><input type="checkbox"/> [AABB] (AAbb): For signals A, A-, B, B-.<br><input type="checkbox"/> [AB] (Ab): For signals A and B.<br><input type="checkbox"/> [A] (A) : For signal A. Value cannot be accessed if [Encoder usage] (EnU) page 99 = [Spd fdk reg.] (rEG).   |                  |                 |
| <b>EnC</b>             | <b>□ [Encoder check]</b><br><br>Checks the encoder feedback. See procedure page 77.<br>The parameter can be accessed if an encoder card has been inserted and if [Encoder usage] (EnU) page 99 is not [Speed ref.] (PGr).  |                  | [Not done] (nO) |
| nO<br>YES<br>dOnE      | <input type="checkbox"/> [Not done] (nO): Check not performed.<br><input type="checkbox"/> [Yes] (YES): Activates monitoring of the encoder.<br><input type="checkbox"/> [Done] (dOnE): Check performed successfully.<br>The check procedure checks: <ul style="list-style-type: none"> <li>- The direction of rotation of the encoder/motor</li> <li>- The presence of signals (wiring continuity)</li> <li>- The number of pulses/revolution</li> </ul> If a fault is detected, the drive locks in [Encoder fault] (EnF) fault mode. |                  |                 |

## [1.5 INPUTS / OUTPUTS CFG] (I-O-)

| Code  | Name/Description  | Adjustment range | Factory setting |
|---|---|------------------|-----------------|
| <b>■ [ENCODER CONFIGURATION]</b> (continued)        |   |                  |                 |
| <i>EnU</i>  | <input type="checkbox"/> <b>[Encoder usage]</b><br>The parameter can be accessed if an encoder card has been inserted.<br><input type="checkbox"/> <b>[No]</b> (nO): Function inactive. In this case, the other parameters cannot be accessed.<br><input type="checkbox"/> <b>[Fdbk monit.]</b> (SEC): The encoder provides speed feedback for monitoring only.<br><input type="checkbox"/> <b>[Spd fdk reg.]</b> (rEG): The encoder provides speed feedback for regulation and monitoring. This configuration is automatic if the drive has been configured for closed-loop operation, and is only possible in this case.<br><input type="checkbox"/> <b>[Speed ref.]</b> (PGr): The encoder provides a reference. |                  | [No] (nO)       |
| <i>nO</i><br><i>SEC</i><br><i>rEG</i><br><i>PGr</i> |   |                  |                 |
| <i>PGr</i>  | <input type="checkbox"/> <b>[Number of pulses]</b><br>Number of pulses per encoder revolution.<br>The parameter can be accessed if an encoder card has been inserted.   | 100 to 5000      | 1024            |
| <i>PGr</i>  |   |                  |                 |
| <i>PGr</i>  | <input type="checkbox"/> <b>[Reference type]</b><br>The parameter can be accessed if <b>[Encoder usage]</b> (EnU) = <b>[Speed ref.]</b> (PGr).<br><input type="checkbox"/> <b>[Encoder]</b> (EnC) : Use of an encoder.<br><input type="checkbox"/> <b>[Freq. gen.]</b> (PtG): Use of a frequency generator (unsigned reference).  |                  | [Encoder] (EnC) |
| <i>EnC</i><br><i>PtG</i>                            |   |                  |                 |
| <i>EnU</i>  | <input type="checkbox"/> <b>[Freq. min. value]</b><br>The parameter can be accessed if <b>[Encoder usage]</b> (EnU) = <b>[Speed ref.]</b> (PGr) and if <b>[Reference type]</b> (PGA) = <b>[Freq. gen.]</b> (PtG).<br>Frequency corresponding to the minimum speed   | - 300 to 300 kHz | 0               |
| <i>EnU</i>  |   |                  |                 |
| <i>EnU</i>  | <input type="checkbox"/> <b>[Freq. max value]</b><br>The parameter can be accessed if <b>[Encoder usage]</b> (EnU) = <b>[Speed ref.]</b> (PGr) and if <b>[Reference type]</b> (PGA) = <b>[Freq. gen.]</b> (PtG).<br>Frequency corresponding to the maximum speed  | 0.00 to 300 kHz  | 300 kHz         |
| <i>EnU</i>  |   |                  |                 |
| <i>EnU</i>  | <input type="checkbox"/> <b>[Freq. signal filter]</b><br>The parameter can be accessed if <b>[Encoder usage]</b> (EnU) = <b>[Speed ref.]</b> (PGr).<br>Interference filtering.  | 0 to 1000 ms     | 0               |
| <i>EnU</i>  |   |                  |                 |

# [1.5 INPUTS / OUTPUTS CFG] (I-O-)

| Code                      | Name/Description   | Adjustment range | Factory setting      |
|---------------------------|--|------------------|----------------------|
| <b>[R1 CONFIGURATION]</b> |  |                  |                      |
| <i>r l</i>                | <input type="checkbox"/> <b>[R1 Assignment]</b>  |                  | [No drive flt] (FLt) |
| <i>nO</i>                 | <input type="checkbox"/> <b>[No] (nO): Not assigned</b>  |                  |                      |
| <i>FLt</i>                | <input type="checkbox"/> <b>[No drive flt] (FLt):</b> Drive not faulty (relay normally energized, and de-energized if there is a fault)    |                  |                      |
| <i>rUn</i>                | <input type="checkbox"/> <b>[Drv running] (rUn):</b> Drive running   |                  |                      |
| <i>FtA</i>                | <input type="checkbox"/> <b>[Freq. Th. attain.] (FtA):</b> Frequency threshold attained ([ <b>Freq. threshold</b> ] (Ftd) page 65)         |                  |                      |
| <i>FLA</i>                | <input type="checkbox"/> <b>[HSP attain.] (FLA):</b> High speed attained   |                  |                      |
| <i>CtA</i>                | <input type="checkbox"/> <b>[I attained] (CtA):</b> Current threshold attained ([ <b>Current threshold</b> ] (Ctd) page 64)                |                  |                      |
| <i>SrA</i>                | <input type="checkbox"/> <b>[Freq.ref.att] (SrA):</b> Frequency reference attained   |                  |                      |
| <i>tSA</i>                | <input type="checkbox"/> <b>[Th.mot. att.] (tSA):</b> Motor 1 thermal state attained   |                  |                      |
| <i>PEE</i>                | <input type="checkbox"/> <b>[PID error al] (PEE):</b> PID error alarm  |                  |                      |
| <i>PFA</i>                | <input type="checkbox"/> <b>[PID fdbk al] (PFA):</b> PID feedback alarm  |                  |                      |
| <i>AP2</i>                | <input type="checkbox"/> <b>[AI2 Al. 4-20] (AP2):</b> Alarm indicating absence of 4-20 mA signal on input A12                              |                  |                      |
| <i>F2A</i>                | <input type="checkbox"/> <b>[Freq. Th 2 attain.] (F2A):</b> Frequency threshold 2 attained ([ <b>Freq. threshold 2</b> ] (F2d) page 65)    |                  |                      |
| <i>tAd</i>                | <input type="checkbox"/> <b>[Th. drv. att.] (tAd):</b> Drive thermal state attained  |                  |                      |
| <i>rSdA</i>               | <input type="checkbox"/> <b>[Rope slack] (rSdA):</b> Rope slack (see [ <b>Rope slack config.</b> ] parameter (rSd) page 168)               |                  |                      |
| <i>ttHA</i>               | <input type="checkbox"/> <b>[High tq. att.] (ttHA):</b> Motor torque overshooting high threshold[ <b>High torque thd.</b> ] (ttH) page 64. |                  |                      |
| <i>ttLA</i>               | <input type="checkbox"/> <b>[Low tq. att.] (ttLA):</b> Motor torque undershooting low threshold[ <b>Low torque thd.</b> ] (ttL) page 64.   |                  |                      |
| <i>MFrd</i>               | <input type="checkbox"/> <b>[Forward] (MFrd):</b> Motor in forward rotation  |                  |                      |
| <i>MrrS</i>               | <input type="checkbox"/> <b>[Reverse] (MrrS):</b> Motor in reverse rotation  |                  |                      |
| <i>tS2</i>                | <input type="checkbox"/> <b>[Th.mot2 att] (tS2):</b> Motor 2 thermal state attained  |                  |                      |
| <i>tS3</i>                | <input type="checkbox"/> <b>[Th.mot3 att] (tS3):</b> Motor 3 thermal state attained  |                  |                      |
| <i>AtS</i>                | <input type="checkbox"/> <b>[Neg Torque] (AtS):</b> Negative torque (braking)  |                  |                      |
| <i>CnF0</i>               | <input type="checkbox"/> <b>[Cnfg.0 act.] (CnF0):</b> Configuration 0 active   |                  |                      |
| <i>CnF1</i>               | <input type="checkbox"/> <b>[Cnfg.1 act.] (CnF1):</b> Configuration 1 active   |                  |                      |
| <i>CnF2</i>               | <input type="checkbox"/> <b>[Cnfg.2 act.] (CnF2):</b> Configuration 2 active   |                  |                      |
| <i>CFP1</i>               | <input type="checkbox"/> <b>[Set 1 active] (CFP1):</b> Parameter set 1 active  |                  |                      |
| <i>CFP2</i>               | <input type="checkbox"/> <b>[Set 2 active] (CFP2):</b> Parameter set 2 active  |                  |                      |
| <i>CFP3</i>               | <input type="checkbox"/> <b>[Set 3 active] (CFP3):</b> Parameter set 3 active  |                  |                      |
| <i>dbL</i>                | <input type="checkbox"/> <b>[DC charged] (dbL):</b> DC bus charging  |                  |                      |
| <i>brS</i>                | <input type="checkbox"/> <b>[In braking] (brS):</b> Drive braking  |                  |                      |
| <i>PRM</i>                | <input type="checkbox"/> <b>[P. removed] (PRM):</b> Drive locked by "Power removal" input  |                  |                      |
| <i>FqLA</i>               | <input type="checkbox"/> <b>[Fr.met. alar.] (FqLA):</b> Measured speed threshold attained: [ <b>Pulse warning thd.</b> ] (FqL) page 65.    |                  |                      |
| <i>MCP</i>                | <input type="checkbox"/> <b>[I present] (MCP):</b> Motor current present   |                  |                      |
| <i>LSA</i>                | <input type="checkbox"/> <b>[Limit sw. att] (LSA):</b> Limit switch attained   |                  |                      |
| <i>dLdA</i>               | <input type="checkbox"/> <b>[Load alarm] (dLdA):</b> Load variation detection (see page 230).  |                  |                      |
| <i>AG1</i>                | <input type="checkbox"/> <b>[Alarm Grp 1] (AG1):</b> Alarm group 1   |                  |                      |
| <i>AG2</i>                | <input type="checkbox"/> <b>[Alarm Grp 2] (AG2):</b> Alarm group 2   |                  |                      |
| <i>AG3</i>                | <input type="checkbox"/> <b>[Alarm Grp 3] (AG3):</b> Alarm group 3   |                  |                      |
| <i>P1A</i>                | <input type="checkbox"/> <b>[PTC1 alarm] (P1A):</b> Probe alarm 1  |                  |                      |
| <i>P2A</i>                | <input type="checkbox"/> <b>[PTC2 alarm] (P2A):</b> Probe alarm 2  |                  |                      |
| <i>PLA</i>                | <input type="checkbox"/> <b>[LI6=PTC al.] (PLA):</b> LI6 = PTC probe alarm   |                  |                      |
| <i>EFA</i>                | <input type="checkbox"/> <b>[Ext. fault al] (EFA):</b> External fault alarm  |                  |                      |
| <i>USA</i>                | <input type="checkbox"/> <b>[Under V. al.] (USA):</b> Undervoltage alarm   |                  |                      |
| <i>UPA</i>                | <input type="checkbox"/> <b>[Uvolt warn] (UPA):</b> Undervoltage warning   |                  |                      |
| <i>AnA</i>                | <input type="checkbox"/> <b>[slipping al.] (AnA):</b> Slipping alarm   |                  |                      |
| <i>tHA</i>                | <input type="checkbox"/> <b>[Al. °C drv] (tHA):</b> Drive overheating  |                  |                      |
| <i>bSA</i>                | <input type="checkbox"/> <b>[Load mvt al] (bSA):</b> Braking speed alarm   |                  |                      |
| <i>bCA</i>                | <input type="checkbox"/> <b>[Brk cont. al] (bCA):</b> Brake contact alarm  |                  |                      |
| <i>SSA</i>                | <input type="checkbox"/> <b>[Lim T/I att.] (SSA):</b> Torque limit alarm   |                  |                      |
| <i>rtA</i>                | <input type="checkbox"/> <b>[Trq. ctrl. al.] (rtA):</b> Torque control alarm   |                  |                      |
| <i>tJA</i>                | <input type="checkbox"/> <b>[IGBT al.] (tJA):</b> IGBT alarm   |                  |                      |
| <i>bOA</i>                | <input type="checkbox"/> <b>[Brake R. al.] (bOA):</b> Braking resistor temperature alarm   |                  |                      |
| <i>APA</i>                | <input type="checkbox"/> <b>[Option al.] (APA):</b> Alarm generated by the Controller Inside card.   |                  |                      |
| <i>AP3</i>                | <input type="checkbox"/> <b>[AI3 Al. 4-20] (AP3):</b> Alarm indicating absence of 4-20 mA signal on input AI3                              |                  |                      |
| <i>AP4</i>                | <input type="checkbox"/> <b>[AI4 Al. 4-20] (AP4):</b> Alarm indicating absence of 4-20 mA signal on input AI4                              |                  |                      |
| <i>rdY</i>                | <input type="checkbox"/> <b>[Ready] (rdY):</b> Drive ready   |                  |                      |

## [1.5 INPUTS / OUTPUTS CFG] (I-O-)

| Code   | Name/Description  | Adjustment range | Factory setting  |
|--|---|------------------|------------------|
| <b>■ [R1 CONFIGURATION]</b> (continued)  |   |                  |                  |
| <i>r 1d</i>  | <input type="checkbox"/> <b>[R1 Delay time]</b><br>The change in state only takes effect once the configured time has elapsed, when the information becomes true.<br>The delay cannot be set for the <b>[No drive flt] (FLt)</b> assignment, and remains at 0.  | 0 to 9999 ms     | 0                |
| <i>r 1S</i><br><br><i>POS</i><br><i>nEG</i>  | <input type="checkbox"/> <b>[R1 Active at]</b><br>Configuration of the operating logic:<br><input type="checkbox"/> <b>[1] (POS)</b> : State 1 when the information is true<br><input type="checkbox"/> <b>[0] (nEG)</b> : State 0 when the information is true<br>Configuration <b>[1] (POS)</b> cannot be modified for the <b>[No drive flt] (FLt)</b> , assignment.  |                  | <b>[1] (POS)</b> |
| <i>r 1H</i>  | <input type="checkbox"/> <b>[R1 Holding time]</b><br>The change in state only takes effect once the configured time has elapsed, when the information becomes false.<br>The holding time cannot be set for the <b>[No drive flt] (FLt)</b> assignment, and remains at 0.  | 0 to 9999 ms     | 0                |
| <b>■ [R2 CONFIGURATION]</b>  |   |                  |                  |
| <i>r 2-</i>  | <b>■ [R2 CONFIGURATION]</b>   |                  |                  |
| <i>r 2</i><br><br><i>bLC</i><br><i>LLC</i><br><i>OCC</i><br><i>EbO</i><br><i>tSY</i><br><i>dCO</i> | <input type="checkbox"/> <b>[R2 Assignment]</b><br>Identical to R1 (see page 100) with the addition of (shown for information only as these selections can only be configured in the <b>[1.7 APPLICATION FUNCT.] (Fun-)</b> menu:<br><input type="checkbox"/> <b>[Brk control] (bLC)</b> : Brake contactor control<br><input type="checkbox"/> <b>[Input cont.] (LLC)</b> : Line contactor control<br><input type="checkbox"/> <b>[Output cont] (OCC)</b> : Output contactor control<br><input type="checkbox"/> <b>[End reel] (EbO)</b> : End of reel(traverse control function)<br><input type="checkbox"/> <b>[Sync. wobble] (tSY)</b> : "Counter wobble" synchronization<br><input type="checkbox"/> <b>[DC charging] (dCO)</b> : DC bus precharging contactor control. |                  | <b>[No] (nO)</b> |
| <i>r 2d</i>  | <input type="checkbox"/> <b>[R2 Delay time]</b><br>The delay cannot be set for the <b>[No drive flt] (FLt)</b> , <b>[Brk control] (bLC)</b> , <b>[Output cont.] (OCC)</b> , <b>[DC charging] (dCO)</b> , and <b>[Input cont.] (LLC)</b> assignments, and remains at 0.<br>The change in state only takes effect once the configured time has elapsed, when the information becomes true.  | 0 to 9999 ms     | 0                |
| <i>r 2S</i><br><br><i>POS</i><br><i>nEG</i>  | <input type="checkbox"/> <b>[R2 Active at]</b><br>Configuration of the operating logic:<br><input type="checkbox"/> <b>[1] (POS)</b> : State 1 when the information is true<br><input type="checkbox"/> <b>[0] (nEG)</b> : State 0 when the information is true<br>The configuration <b>[1] (POS)</b> cannot be modified for the <b>[No drive flt] (FLt)</b> , <b>[Brk control] (bLC)</b> , <b>[DC charging] (dCO)</b> , and <b>[Input cont.] (LLC)</b> assignments.  |                  | <b>[1] (POS)</b> |
| <i>r 2H</i>  | <input type="checkbox"/> <b>[R2 Holding time]</b><br>The holding time cannot be set for the <b>[No drive flt] (FLt)</b> , <b>[Brk control] (bLC)</b> , <b>[DC charging] (dCO)</b> , and <b>[Input cont] (LLC)</b> assignments, and remains at 0.<br>The change in state only takes effect once the configured time has elapsed, when the information becomes false.   | 0 to 9999 ms     | 0                |

## [1.5 INPUTS / OUTPUTS CFG] (I-O-)

| Code   | Name/Description  | Adjustment range | Factory setting |
|--|---|------------------|-----------------|
| <b>r 3 -</b>                                 | <b>■ [R3 CONFIGURATION]</b><br>Can be accessed if a VW3A3201 option card has been inserted  |                  |                 |
| <b>r 3</b>                                   | <input type="checkbox"/> <b>[R3 Assignment]</b><br>Identical to R2  |                  | [No] (nO)       |
| <b>r 3 d</b>                                 | <input type="checkbox"/> <b>[R3 Delay time]</b><br>The delay cannot be set for the [No drive flt] (FLt), [Brk control] (bLC), [Output cont.] (OCC), [DC charging] (dCO), and [Input cont.] (LLC) assignments, and remains at 0.<br>The change in state only takes effect once the configured time has elapsed, when the information becomes true.   | 0 to 9999 ms     | 0               |
| <b>r 3 5</b><br><br><b>POS</b><br><b>nEG</b> | <input type="checkbox"/> <b>[R3 Active at]</b><br>Configuration of the operating logic:<br><input type="checkbox"/> <b>[1] (POS)</b> : State 1 when the information is true<br><input type="checkbox"/> <b>[0] (nEG)</b> : State 0 when the information is true<br>The configuration [1 ] (POS) cannot be modified for the [No drive flt] (FLt), [Brk control] (bLC), [DC charging] (dCO), and [Input cont.] (LLC) assignments. |                  | [1 ] (POS)      |
| <b>r 3 H</b>                                 | <input type="checkbox"/> <b>[R3 Holding time]</b><br>The holding time cannot be set for the [No drive flt] (FLt), [Brk control] (bLC), [DC charging] (dCO), and [Input cont.] (LLC) assignments, and remains at 0.<br>The change in state only takes effect once the configured time has elapsed, when the information becomes false.   | 0 to 9999 ms     | 0               |
| <b>r 4 -</b>                                 | <b>■ [R4 CONFIGURATION]</b><br>Can be accessed if a VW3A3202 option card has been inserted  |                  |                 |
| <b>r 4</b>                                   | <input type="checkbox"/> <b>[R4 Assignment]</b><br>Identical to R2 (see page 101)   |                  | [No] (nO)       |
| <b>r 4 d</b>                                 | <input type="checkbox"/> <b>[R4 Delay time]</b><br>The delay cannot be set for the [No drive flt] (FLt), [Brk control] (bLC), [Output cont.] (OCC), [DC charging] (dCO), and [Input cont.] (LLC) assignments, and remains at 0.<br>The change in state only takes effect once the configured time has elapsed, when the information becomes true.   | 0 to 9999 ms     | 0               |
| <b>r 4 5</b><br><br><b>POS</b><br><b>nEG</b> | <input type="checkbox"/> <b>[R4 Active at]</b><br>Configuration of the operating logic:<br><input type="checkbox"/> <b>[1] (POS)</b> : State 1 when the information is true<br><input type="checkbox"/> <b>[0] (nEG)</b> : State 0 when the information is true<br>The configuration [1 ] (POS) cannot be modified for the [No drive flt] (FLt), [Brk control] (bLC), [DC charging] (dCO), and [Input cont.] (LLC) assignments. |                  | [1 ] (POS)      |
| <b>r 4 H</b>                                 | <input type="checkbox"/> <b>[R4 Holding time]</b><br>The holding time cannot be set for the [No drive flt] (FLt), [Brk control] (bLC), [DC charging] (dCO), and [Input cont.] (LLC) assignments, and remains at 0.<br>The change in state only takes effect once the configured time has elapsed, when the information becomes false.   | 0 to 9999 ms     | 0               |

# [1.5 INPUTS / OUTPUTS CFG] (I-O-)

| Code   | Name/Description  | Adjustment range | Factory setting |
|--|---|------------------|-----------------|
| <b>LO1-</b>  | <b>[LO1 CONFIGURATION]</b><br>Can be accessed if a VW3A3201 option card has been inserted   |                  |                 |
| <b>LO1</b>   | <input type="checkbox"/> <b>[LO1 assignment]</b><br>Identical to R1 (see page 100) with the addition of (shown for information only as these selections can only be configured in the [1.7 APPLICATION FUNCT.] (Fun-) menu:<br><input type="checkbox"/> <b>[Brk control] (bLC)</b> : Brake contactor control<br><input type="checkbox"/> <b>[Input cont.] (LLC)</b> : Line contactor control<br><input type="checkbox"/> <b>[Output cont] (OCC)</b> : Output contactor control<br><input type="checkbox"/> <b>[End reel] (EbO)</b> : End of reel(traverse control function)<br><input type="checkbox"/> <b>[Sync. wobble] (tSY)</b> : "Counter wobble" synchronization<br><input type="checkbox"/> <b>[DC charging] (dCO)</b> : DC bus precharging contactor control. |                  | [No] (nO)       |
| <i>bLC</i><br><i>LLC</i><br><i>OCC</i><br><i>EbO</i><br><i>tSY</i><br><i>dCO</i> |   |                  |                 |
| <b>LO1d</b>  | <input type="checkbox"/> <b>[LO1 delay time]</b><br>The delay cannot be set for the [No drive flt] (FLt), [Brk control] (bLC), [Output cont.] (OCC), [DC charging] (dCO), and [Input cont.] (LLC) assignments, and remains at 0.<br>The change in state only takes effect once the configured time has elapsed, when the information becomes true.  | 0 to 9999 ms     | 0               |
| <b>LO1S</b>  | <input type="checkbox"/> <b>[LO1 active at]</b><br>Configuration of the operating logic:<br><input type="checkbox"/> <b>[1] (POS)</b> : State 1 when the information is true<br><input type="checkbox"/> <b>[0] (nEG)</b> : State 0 when the information is true<br>The configuration [1] (POS) cannot be modified for the [No drive flt] (FLt), [Brk control] (bLC), [DC charging] (dCO), and [Input cont.] (LLC) assignments.   |                  | [1] (POS)       |
| <i>POS</i><br><i>nEG</i>   |   |                  |                 |
| <b>LO1H</b>  | <input type="checkbox"/> <b>[LO1 holding time]</b><br>The holding time cannot be set for the [No drive flt] (FLt), [Brk control] (bLC), [DC charging] (dCO), and [Input cont] (LLC) assignments, and remains at 0.<br>The change in state only takes effect once the configured time has elapsed, when the information becomes false.   | 0 to 9999 ms     | 0               |
| <b>LO2-</b>  | <b>[LO2 CONFIGURATION]</b><br>Can be accessed if a VW3A3201 option card has been inserted   |                  |                 |
| <b>LO2</b>   | <input type="checkbox"/> <b>[LO2 assignment]</b><br>Identical to LO1.   |                  | [No] (nO)       |
| <b>LO2d</b>  | <input type="checkbox"/> <b>[LO2 delay time]</b><br>The delay cannot be set for the [No drive flt] (FLt), [Brk control] (bLC), [Output cont.] (OCC), [DC charging] (dCO), and [Input cont.] (LLC) assignments, and remains at 0.<br>The change in state only takes effect once the configured time has elapsed, when the information becomes true.  | 0 to 9999 ms     | 0               |
| <b>LO2S</b>  | <input type="checkbox"/> <b>[LO2 active at]</b><br>Configuration of the operating logic:<br><input type="checkbox"/> <b>[1] (POS)</b> : State 1 when the information is true<br><input type="checkbox"/> <b>[0] (nEG)</b> : State 0 when the information is true<br>The configuration [1] (POS) cannot be modified for the [No drive flt] (FLt), [Brk control] (bLC), [DC charging] (dCO), and [Input cont.] (LLC) assignments.   |                  | [1] (POS)       |
| <i>POS</i><br><i>nEG</i>   |   |                  |                 |
| <b>LO2H</b>  | <input type="checkbox"/> <b>[LO2 holding time]</b><br>The holding time cannot be set for the [No drive flt] (FLt), [Brk control] (bLC), [DC charging] (dCO), and [Input cont] (LLC) assignments, and remains at 0.<br>The change in state only takes effect once the configured time has elapsed, when the information becomes false.   | 0 to 9999 ms     | 0               |

## [1.5 INPUTS / OUTPUTS CFG] (I-O-)

| Code        | Name/Description  | Adjustment range | Factory setting |
|-------------|---|------------------|-----------------|
| <b>L03-</b> | <b>■ [LO3 CONFIGURATION]</b><br>Can be accessed if a VW3A3202 option card has been inserted   |                  |                 |
| L03         | <input type="checkbox"/> <b>[LO3 assignment]</b><br>Identical to LO1 (see page 103).  |                  | [No] (nO)       |
| L03d        | <input type="checkbox"/> <b>[LO3 delay time]</b><br>The delay cannot be set for the [No drive flt] (FLt), [Brk control] (bLC), [Output cont.] (OCC), [DC charging] (dCO), and [Input cont.] (LLC) assignments, and remains at 0.<br>The change in state only takes effect once the configured time has elapsed, when the information becomes true.  | 0 to 9999 ms     | 0               |
| L035        | <input type="checkbox"/> <b>[LO3 active at]</b><br>Configuration of the operating logic:<br><input type="checkbox"/> [1] (POS): State 1 when the information is true<br><input type="checkbox"/> [0] (nEG): State 0 when the information is true<br>The configuration [1] (POS) cannot be modified for the [No drive flt] (FLt), [Brk control] (bLC), [DC charging] (dCO), and [Input cont.] (LLC) assignments. |                  | [1] (POS)       |
| L03H        | <input type="checkbox"/> <b>[LO3 holding time]</b><br>The holding time cannot be set for the [No drive flt] (FLt), [Brk control] (bLC), [DC charging] (dCO), and [Input cont.] (LLC) assignments, and remains at 0.<br>The change in state only takes effect once the configured time has elapsed, when the information becomes false.  | 0 to 9999 ms     | 0               |
| <b>L04-</b> | <b>■ [LO4 CONFIGURATION]</b><br>Can be accessed if a VW3A3202 option card has been inserted   |                  |                 |
| L04         | <input type="checkbox"/> <b>[LO4 assignment]</b><br>Identical to LO1 (see page 103).  |                  | [No] (nO)       |
| L04d        | <input type="checkbox"/> <b>[LO4 delay time]</b><br>The delay cannot be set for the [No drive flt] (FLt), [Brk control] (bLC), [Output cont.] (OCC), [DC charging] (dCO), and [Input cont.] (LLC) assignments, and remains at 0.<br>The change in state only takes effect once the configured time has elapsed, when the information becomes true.  | 0 to 9999 ms     | 0               |
| L045        | <input type="checkbox"/> <b>[LO4 active at]</b><br>Configuration of the operating logic:<br><input type="checkbox"/> [1] (POS): State 1 when the information is true<br><input type="checkbox"/> [0] (nEG): State 0 when the information is true<br>The configuration [1] (POS) cannot be modified for the [No drive flt] (FLt), [Brk control] (bLC), [DC charging] (dCO), and [Input cont.] (LLC) assignments. |                  | [1] (POS)       |
| L04H        | <input type="checkbox"/> <b>[LO4 holding time]</b><br>The holding time cannot be set for the [No drive flt] (FLt), [Brk control] (bLC), [DC charging] (dCO), and [Input cont.] (LLC) assignments, and remains at 0.<br>The change in state only takes effect once the configured time has elapsed, when the information becomes false.  | 0 to 9999 ms     | 0               |



## [1.5 INPUTS / OUTPUTS CFG] (I-O-)

### Use of analog output AO1 as a logic output

Analog output AO1 can be used as a logic output, by assigning DO1. In this case, when set to 0 this output corresponds to the AO1 min. value (0 V or 0 mA, for example), and when set to 1 to the AO1 max. value (10 V or 20 mA, for example).

The electrical characteristics of this analog output remain unchanged. As these differ from logic output characteristics, it is important to ensure that they are compatible with the intended application.

| Code   | Name/Description   | Adjustment range | Factory setting |
|--|--|------------------|-----------------|
| <b>do1-</b>  | <b>■ [DO1 CONFIGURATION]</b>   |                  |                 |
| <b>do1</b><br><br><i>bLC</i><br><i>LLC</i><br><i>OCC</i><br><i>EbO</i><br><i>tSY</i><br><i>dCO</i> | <input type="checkbox"/> <b>[DO1 assignment]</b><br><br>Identical to R1 (see page 100) with the addition of (shown for information only as these selections can only be configured in the [1.7 APPLICATION FUNCT.] (Fun-) menu:<br><input type="checkbox"/> <b>[Brk control] (bLC)</b> : Brake contactor control<br><input type="checkbox"/> <b>[Input cont.] (LLC)</b> : Line contactor control<br><input type="checkbox"/> <b>[Output cont.] (OCC)</b> : Output contactor control<br><input type="checkbox"/> <b>[End reel] (EbO)</b> : End of reel(traverse control function)<br><input type="checkbox"/> <b>[Sync. wobble] (tSY)</b> : "Counter wobble" synchronization<br><input type="checkbox"/> <b>[DC charging] (dCO)</b> : DC bus precharging contactor control. |                  | [No] (nO)       |
| <b>do1d</b>  | <input type="checkbox"/> <b>[DO1 delay time]</b><br><br>The delay cannot be set for the [No drive flt] (FLt), [Brk control] (bLC), [Output cont.] (OCC), [DC charging] (dCO), and [Input cont.] (LLC) assignments, and remains at 0.<br>The change in state only takes effect once the configured time has elapsed, when the information becomes true.   | 0 to 9999 ms     | 0               |
| <b>do1s</b><br><br><i>POS</i><br><i>nEG</i>  | <input type="checkbox"/> <b>[DO1 active at]</b><br><br>Configuration of the operating logic:<br><input type="checkbox"/> <b>[1] (POS)</b> : State 1 when the information is true<br><input type="checkbox"/> <b>[0] (nEG)</b> : State 0 when the information is true<br>The configuration [1 ] (POS) cannot be modified for the [No drive flt] (FLt), [Brk control] (bLC), [DC charging] (dCO), and [Input cont.] (LLC) assignments.   |                  | [1] (POS)       |
| <b>do1h</b>  | <input type="checkbox"/> <b>[DO1 holding time]</b><br><br>The holding time cannot be set for the [No drive flt] (FLt), [Brk control] (bLC), [DC charging] (dCO), and [Input cont.] (LLC) assignments, and remains at 0.<br>The change in state only takes effect once the configured time has elapsed, when the information becomes false.   | 0 to 9999 ms     | 0               |

## Configuration of analog outputs

### Minimum and maximum values (output values):

The minimum output value, in volts or mA, corresponds to the lower limit of the assigned parameter and the maximum value corresponds to its upper limit. The minimum value may be greater than the maximum value:

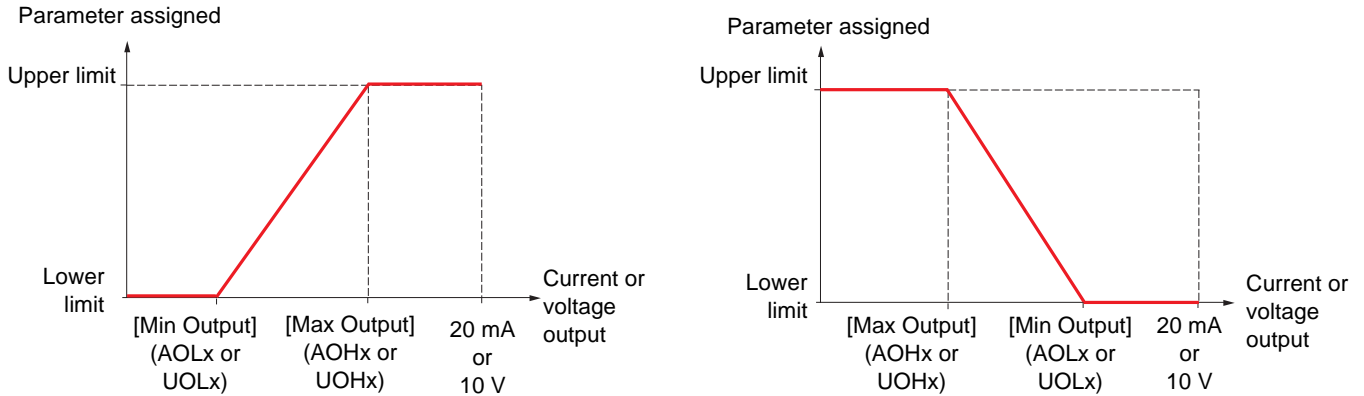

### Outputs AO2 and AO3 configured as bipolar outputs (strongly recommended for signed parameters):

The [min Output] (UOLx) and [max Output] (UOHx) parameters are absolute values, although they function symmetrically. In the case of bipolar outputs, always set the maximum value higher than the minimum value.

The [max Output] (UOHx) corresponds to the upper limit of the assigned parameter, and the [min Output] (UOLx) corresponds to an average value between the upper and lower limits (0 for a signed and symmetrical parameter such as in the example below).

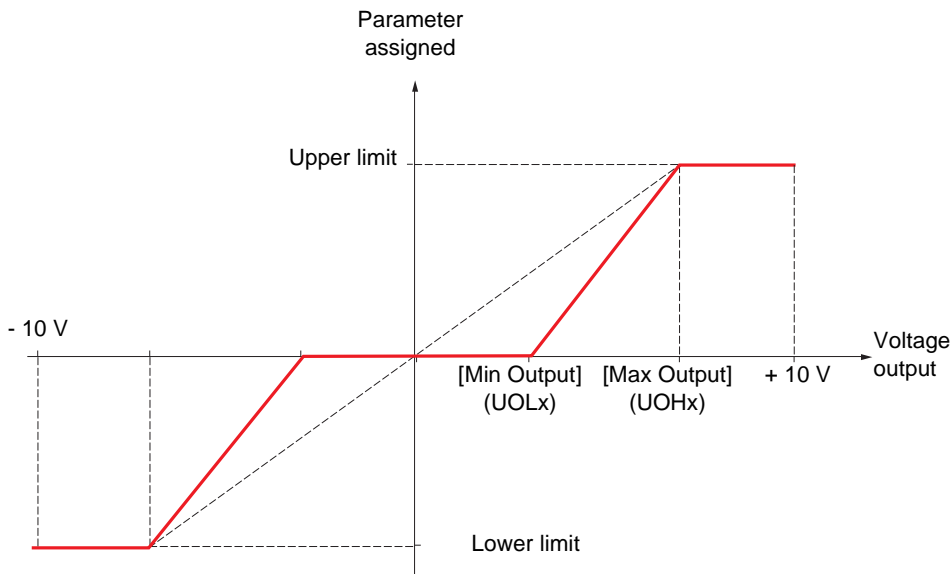

## [1.5 INPUTS / OUTPUTS CFG] (I-O-)

### Scaling of the assigned parameter

The scale of the assigned parameter can be adapted in accordance with requirements by modifying the values of the lower and upper limits by means of two parameters for each analog output.

These parameters are given in %; 100% corresponds to the total variation range of the configured parameter, so:

- 100% = upper limit - lower limit For example, [Sign. torque] (Stq) which varies between -3 and +3 times the rated torque, 100% corresponds to 6 times the rated torque.

- The parameter [Scaling AOx min] (ASLx) modifies the lower limit: new value = lower limit + (range x ASLx). The value 0% (factory setting) does not modify the lower limit.
- The parameter [Scaling AOx max] (ASHx) modifies the upper limit: new value = lower limit + (range x ASLx). The value 100% (factory setting) does not modify the upper limit.
- [Scaling AOx min] (ASLx) must always be lower than [Scaling AOx max] (ASHx).

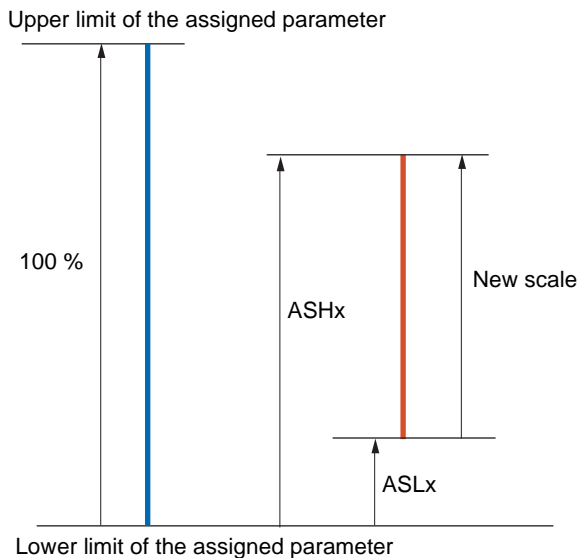

### Application example 1

The value of the signed motor torque at the AO2 output is to be transferred with +/- 10 V, with a range of -2 Tr to +2 Tr.

The parameter [Sign. torque.] (Stq) varies between -3 and +3 times the rated torque, or a range of 6 times the rated torque.

[Scaling AO2 min] (ASL2) must modify the lower limit by 1x the rated torque, or  $100/6 = 16.7\%$  (new value = lower limit + (range x ASL2)).

[Scaling AO2 max] (ASH2) must modify the upper limit by 1x the rated torque, or  $100 - 100/6 = 83.3\%$  (new value = lower limit + (range x ASH2)).

### Application example 2

The value of the motor current at the AO2 output is to be transferred with 0 - 20 mA, range 2 In motor, In motor being the equivalent of a 0.8 In drive.

The parameter [I motor] (OCr) varies between 0 and 2 times the rated drive current, or a range of 2.5 times the rated drive current.

[Scaling AO2 min] (ASL2) must not modify the lower limit, which therefore remains at its factory setting of 0%.

[Scaling AO2 max] (ASH2) must modify the upper limit by 0.5x the rated motor torque, or  $100 - 100/5 = 80\%$  (new value = lower limit + (range x ASH2)).

# [1.5 INPUTS / OUTPUTS CFG] (I-O-)

| Code  | Name/Description   | Adjustment range | Factory setting       |
|---|--|------------------|-----------------------|
| <b>AO1-</b>   | <b>[AO1 CONFIGURATION]</b>   |                  |                       |
| <b>AO1</b>  | <input type="checkbox"/> <b>[AO1 assignment]</b>   |                  | <b>[No] (nO)</b>      |
| nO  | <input type="checkbox"/> <b>[No] (nO)</b> : Not assigned   |                  |                       |
| OCr   | <input type="checkbox"/> <b>[I motor] (OCr)</b> : Current in the motor, between 0 and 2 In (In = rated drive current indicated in the Installation Manual and on the drive nameplate).   |                  |                       |
| OFr   | <input type="checkbox"/> <b>[Motor freq.] (OFr)</b> : Output frequency, from 0 to <b>[Max frequency] (tFr)</b>   |                  |                       |
| OrP   | <input type="checkbox"/> <b>[Ramp out.] (OrP)</b> : From 0 to <b>[Max frequency] (tFr)</b>   |                  |                       |
| tFr   | <input type="checkbox"/> <b>[Motor torq.] (trq)</b> : Motor torque, between 0 and 3 times the rated motor torque.  |                  |                       |
| Stq   | <input type="checkbox"/> <b>[Sign. torque] (Stq)</b> : Signed motor torque, between -3 and +3 times the rated motor torque. The + sign corresponds to the motor mode and the - sign to the generator mode (braking).   |                  |                       |
| OrS   | <input type="checkbox"/> <b>[sign ramp] (OrS)</b> : Signed ramp output, between - <b>[Max frequency] (tFr)</b> and + <b>[Max frequency] (tFr)</b>  |                  |                       |
| OPS   | <input type="checkbox"/> <b>[PID ref.] (OPS)</b> : PID regulator reference between <b>[Min PID reference] (PIP1)</b> and <b>[Max PID reference] (PIP2)</b>   |                  |                       |
| OPF   | <input type="checkbox"/> <b>[PID feedback] (OPF)</b> : PID regulator feedback between <b>[Min PID feedback] (PIF1)</b> and <b>[Max PID feedback] (PIF2)</b>  |                  |                       |
| OPE   | <input type="checkbox"/> <b>[PID error] (OPE)</b> : PID regulator error between - 5 % and + 5 % of ( <b>[Max PID feedback] (PIF2)</b> - <b>[Min PID feedback] (PIF1)</b> )   |                  |                       |
| OPI   | <input type="checkbox"/> <b>[PID Output] (OPI)</b> : PID regulator output between <b>[Low speed] (LSP)</b> and <b>[High speed] (HSP)</b>   |                  |                       |
| OPr   | <input type="checkbox"/> <b>[Mot. power] (OPr)</b> : Motor power, between 0 and 2.5 times <b>[Rated motor power] (nPr)</b>   |                  |                       |
| tHr   | <input type="checkbox"/> <b>[Mot thermal] (tHr)</b> : Motor thermal state, between 0 and 200% of the rated thermal state.  |                  |                       |
| tHd   | <input type="checkbox"/> <b>[Drv thermal] (tHd)</b> : Drive thermal state, between 0 and 200% of the rated thermal state.  |                  |                       |
| tqMS  | <input type="checkbox"/> <b>[Torque 4Q] (tqMS)</b> : Signed motor torque, between -3 and +3 times the rated motor torque. The + sign and the - sign correspond to the physical direction of the torque, regardless of mode (motor or generator). Example of usage: "master-slave" with the <b>TORQUE CONTROL] (tOr-)</b> function, page 179. |                  |                       |
| OFrr  | <input type="checkbox"/> <b>[Meas.mot.fr] (OFrr)</b> : Measured motor speed.   |                  |                       |
| OFS   | <input type="checkbox"/> <b>[Sig. o/p frq.] (OFS)</b> : Signed output frequency, between - <b>[Max frequency] (tFr)</b> and + <b>[Max frequency] (tFr)</b>   |                  |                       |
| tHr2  | <input type="checkbox"/> <b>[Mot therm2] (tHr2)</b> : Motor thermal state 2, between 0 and 200 % of the rated thermal state.   |                  |                       |
| tHr3  | <input type="checkbox"/> <b>[Mot therm3] (tHr3)</b> : Motor thermal state 3, between 0 and 200% of the rated thermal state.  |                  |                       |
| Utr   | <input type="checkbox"/> <b>[Uns. TrqRef] (Utr)</b> : Torque reference, between 0 and 3 times the rated motor torque   |                  |                       |
| Stq   | <input type="checkbox"/> <b>[Uns. TrqRef] (Utr)</b> : Signed torque reference, between - 3 and + 3 times the rated motor torque  |                  |                       |
| tqL   | <input type="checkbox"/> <b>[Torque lim.] (tqL)</b> : Torque limit, between 0 and 3 times the rated motor torque   |                  |                       |
| UOP   | <input type="checkbox"/> <b>[Motor volt.] (UOP)</b> : Voltage applied to the motor, between 0 and <b>[Rated motor volt.] (UnS)</b>   |                  |                       |
| dO1   | <input type="checkbox"/> <b>[dO1] (dO1)</b> : Assignment to a logic output. This assignment can only appear if <b>[DO1 assignment] (dO1)</b> page 105 has been assigned. This is the only possible choice in this case, and is only displayed for informational purposes.  |                  |                       |
| <b>AO1t</b>   | <input type="checkbox"/> <b>[AO1 Type]</b>   |                  | <b>[Current] (0A)</b> |
| 10U   | <input type="checkbox"/> <b>[Voltage] (10U)</b> : Voltage output   |                  |                       |
| 0A  | <input type="checkbox"/> <b>[Current] (0A)</b> : Current output  |                  |                       |
| <b>AO1</b>  | <input type="checkbox"/> <b>[AO1 min Output]</b>   | 0 to 20.0 mA     | 0 mA                  |
| The parameter can be accessed if <b>[AO1 Type] (AO1t) = [Current] (0A)</b>  |  |                  |                       |
| <b>AOH</b>  | <input type="checkbox"/> <b>[AO1 max Output]</b>   | 0 to 20.0 mA     | 20.0 mA               |
| The parameter can be accessed if <b>[AO1 Type] (AO1t) = [Current] (0A)</b>  |  |                  |                       |
| <b>UO1</b>  | <input type="checkbox"/> <b>[AO1 min Output]</b>   | 0 to 10.0 V      | 0 V                   |
| The parameter can be accessed if <b>[AO1 Type] (AO1t) = [Voltage] (10U)</b> |  |                  |                       |
| <b>UOH</b>  | <input type="checkbox"/> <b>[AO1 max Output]</b>   | 0 to 10.0 V      | 10.0 V                |
| The parameter can be accessed if <b>[AO1 Type] (AO1t) = [Voltage] (10U)</b> |  |                  |                       |

## [1.5 INPUTS / OUTPUTS CFG] (I-O-)

| Code         | Name/Description   | Adjustment range | Factory setting |
|--------------|--|------------------|-----------------|
| <b>AD I-</b> | <b>■ [AO1 CONFIGURATION]</b> (continued)   |                  |                 |
| <b>ASL I</b> | <input type="checkbox"/> <b>[Scaling AO1 min]</b><br>Scaling of the lower limit of the assigned parameter, as a % of the maximum possible variation.   | 0 to 100.0 %     | 0 %             |
| <b>ASH I</b> | <input type="checkbox"/> <b>[Scaling AO1 max]</b><br>Scaling of the upper limit of the assigned parameter, as a % of the maximum possible variation.   | 0 to 100.0 %     | 100.0 %         |
| <b>AD IF</b> | <input type="checkbox"/> <b>[AO1 Filter]</b><br>Interference filtering. This parameter is forced to 0 if <b>[AO1 assignment] (AO1) = [dO1] (dO1)</b> . | 0 to 10.00 s     | 0 s             |

# [1.5 INPUTS / OUTPUTS CFG] (I-O-)

| Code   | Name/Description  | Adjustment range | Factory setting |
|--|---|------------------|-----------------|
| <b>AO2 -</b>   | <b>■ [AO2 CONFIGURATION]</b><br>Can be accessed if a VW3A3202 option card has been inserted   |                  |                 |
| <b>AO2</b>   | <input type="checkbox"/> <b>[AO2 assignment]</b><br>Same assignments as AO1, without [dO1] (dO1).   |                  | [No] (nO)       |
| <b>AO2t</b><br><i>10U</i><br><i>0A</i><br><i>n 10U</i> | <input type="checkbox"/> <b>[AO2 Type]</b><br><input type="checkbox"/> [Voltage] (10U): Voltage output<br><input type="checkbox"/> [Current] (0A): Current output<br><input type="checkbox"/> [Voltage +/-] (n10U): Bipolar voltage output. |                  | [Current] (0A)  |
| <b>AO2L</b>  | <input type="checkbox"/> <b>[AO2 min Output]</b><br>The parameter can be accessed if [AO2 Type] (AO2t) = [Current] (0A)   | 0 to 20.0 mA     | 0 mA            |
| <b>AO2H</b>  | <input type="checkbox"/> <b>[AO2 max Output]</b><br>The parameter can be accessed if [AO2 Type] (AO2t) = [Current] (0A)   | 0 to 20.0 mA     | 20.0 mA         |
| <b>UO2L</b>  | <input type="checkbox"/> <b>[AO2 min Output]</b><br>The parameter can be accessed if [AO2 Type] (AO2t) = [Voltage] (10U) or [Voltage +/-] (n10U)  | 0 to 10.0 V      | 0 V             |
| <b>UO2H</b>  | <input type="checkbox"/> <b>[AO2 max Output]</b><br>The parameter can be accessed if [AO2 Type] (AO2t) = [Voltage] (10U) or [Voltage +/-] (n10U)  | 0 to 10.0 V      | 10.0 V          |
| <b>AS2L</b>  | <input type="checkbox"/> <b>[Scaling AO2 min]</b><br>Scaling of the lower limit of the assigned parameter, as a % of the maximum possible variation.  | 0 to 100.0 %     | 0 %             |
| <b>AS2H</b>  | <input type="checkbox"/> <b>[Scaling AO2 max]</b><br>Scaling of the upper limit of the assigned parameter, as a % of the maximum possible variation.  | 0 to 100.0 %     | 100.0 %         |
| <b>AO2F</b>  | <input type="checkbox"/> <b>[AO2 Filter]</b><br>Interference filtering.   | 0 to 10.00 s     | 0 s             |

## [1.5 INPUTS / OUTPUTS CFG] (I-O-)

| Code        | Name/Description  | Adjustment range | Factory setting |
|-------------|---|------------------|-----------------|
| <b>AO3-</b> | <b>■ [AO3 CONFIGURATION]</b><br>Can be accessed if a VW3A3202 option card has been inserted   |                  |                 |
| <b>AO3</b>  | <input type="checkbox"/> <b>[AO3 assignment]</b><br>Same assignments as AO1, without [dO1] (dO1).   |                  | [No] (nO)       |
| <b>AO3t</b> | <input type="checkbox"/> <b>[AO3 Type]</b><br><input type="checkbox"/> [Voltage] (10U): Voltage output<br><input type="checkbox"/> [Current] (0A): Current output<br><input type="checkbox"/> [Voltage +/-] (n10U): Bipolar voltage output. |                  | [Current] (0A)  |
| <b>AO3L</b> | <input type="checkbox"/> <b>[AO3 min Output]</b><br>The parameter can be accessed if [AO3 Type] (AO3t) = [Current] (0A)   | 0 to 20.0 mA     | 0 mA            |
| <b>AO3H</b> | <input type="checkbox"/> <b>[AO3 max Output]</b><br>The parameter can be accessed if [AO3 Type] (AO3t) = [Current] (0A)   | 0 to 20.0 mA     | 20.0 mA         |
| <b>UO3L</b> | <input type="checkbox"/> <b>[AO3 min Output]</b><br>The parameter can be accessed if [AO3 Type] (AO3t) = [Voltage] (10U) or [Voltage +/-] (n10U)  | 0 to 10.0 V      | 0 V             |
| <b>UO3H</b> | <input type="checkbox"/> <b>[AO3 max Output]</b><br>The parameter can be accessed if [AO3 Type] (AO3t) = [Voltage] (10U) or [Voltage +/-] (n10U)  | 0 to 10.0 V      | 10.0 V          |
| <b>AS3L</b> | <input type="checkbox"/> <b>[Scaling AO3 min]</b><br>Scaling of the lower limit of the assigned parameter, as a % of the maximum possible variation.  | 0 to 100.0 %     | 0 %             |
| <b>AS3H</b> | <input type="checkbox"/> <b>[Scaling AO3 max]</b><br>Scaling of the upper limit of the assigned parameter, as a % of the maximum possible variation.  | 0 to 100.0 %     | 100.0 %         |
| <b>AO3F</b> | <input type="checkbox"/> <b>[AO3 Filter]</b><br>Interference filtering.   | 0 to 10.00 s     | 0 s             |

## [1.5 INPUTS / OUTPUTS CFG] (I-O-)

The following submenus group the alarms into 1 to 3 groups, each of which can be assigned to a relay or a logic output for remote signaling. These groups can also be displayed on the graphic display terminal (see [6 MONITORING CONFIG.] menu) and viewed via the [1.2 MONITORING] (SUP) menu.

When one or a number of alarms selected in a group occurs, this alarm group is activated.

| Code        | Name/Description   | Adjustment range | Factory setting |
|-------------|--|------------------|-----------------|
| <b>A1C-</b> | <b>[ALARM GRP1 DEFINITION]</b>   |                  |                 |
|             | <p>Selection to be made from the following list:</p> <ul style="list-style-type: none"> <li><input type="checkbox"/> <b>[LI6=PTC al.] (PLA)</b>: LI6 = PTC probe alarm</li> <li><input type="checkbox"/> <b>[PTC1 alarm] (P1A)</b>: Probe alarm 1</li> <li><input type="checkbox"/> <b>[PTC2 alarm] (P2A)</b>: Probe alarm 2</li> <li><input type="checkbox"/> <b>[Ext. fault al.] (EFA)</b>: External fault alarm</li> <li><input type="checkbox"/> <b>[Under V. al.] (USA)</b>: Undervoltage alarm</li> <li><input type="checkbox"/> <b>[slipping al.] (AnA)</b>: Slipping alarm</li> <li><input type="checkbox"/> <b>[I attained] (CtA)</b>: Current threshold attained (<b>[Current threshold] (Ctd)</b> page 64)</li> <li><input type="checkbox"/> <b>[Freq.Th.att.] (FtA)</b>: Frequency threshold attained (<b>[Freq. threshold] (Ftd)</b> page 65)</li> <li><input type="checkbox"/> <b>[Freq. Th. 2 attain.] (F2A)</b>: Frequency threshold 2 attained (<b>[Freq. Th. 2 attain] (F2d)</b> page 65)</li> <li><input type="checkbox"/> <b>[Freq.ref.att.] (SrA)</b>: Frequency reference attained</li> <li><input type="checkbox"/> <b>[Th.mot. att.] (tSA)</b>: Motor 1 thermal state attained</li> <li><input type="checkbox"/> <b>[Th.mot2 att] (tS2)</b>: Motor 2 thermal state attained</li> <li><input type="checkbox"/> <b>[Th.mot3 att] (tS3)</b>: Motor 3 thermal state attained</li> <li><input type="checkbox"/> <b>[Uvolt warn] (UPA)</b>: Undervoltage warning</li> <li><input type="checkbox"/> <b>[HSP attain.] (FLA)</b>: High speed attained</li> <li><input type="checkbox"/> <b>[Al. °C drv] (tHA)</b>: Drive overheating</li> <li><input type="checkbox"/> <b>[Load mvt al] (bSA)</b>: Braking speed alarm</li> <li><input type="checkbox"/> <b>[Brk cont. al] (bCA)</b>: Brake contact alarm</li> <li><input type="checkbox"/> <b>[PID error al] (PEE)</b>: PID error alarm</li> <li><input type="checkbox"/> <b>[PID fdbk al.] (PFA)</b>: PID feedback alarm</li> <li><input type="checkbox"/> <b>[AI2 Al. 4-20] (AP2)</b>: Alarm indicating absence of 4-20 mA signal on input AI2</li> <li><input type="checkbox"/> <b>[AI3 Al. 4-20] (AP3)</b>: Alarm indicating absence of 4-20 mA signal on input AI3</li> <li><input type="checkbox"/> <b>[AI4 Al. 4-20] (AP4)</b>: Alarm indicating absence of 4-20 mA signal on input AI4</li> <li><input type="checkbox"/> <b>[Lim T/I att.] (SSA)</b>: Torque limit alarm</li> <li><input type="checkbox"/> <b>[Th. drv. att.] (tAd)</b>: Drive thermal state attained</li> <li><input type="checkbox"/> <b>[IGBT alarm] (tJA)</b>: IGBT alarm</li> <li><input type="checkbox"/> <b>[Torque Control al.] (rtA)</b>: Torque control alarm</li> <li><input type="checkbox"/> <b>[Brake R. al.] (bOA)</b>: Braking resistor temperature alarm</li> <li><input type="checkbox"/> <b>[Option al.] (APA)</b>: Alarm generated by an option card.</li> <li><input type="checkbox"/> <b>[Regen. underV. al.] (UrA)</b>: Reserved.</li> <li><input type="checkbox"/> <b>[Rope slack alarm] (rSdA)</b>: Rope slack (see <b>[Rope slack config.] (rSd)</b> parameter page 168)</li> <li><input type="checkbox"/> <b>[High torque alarm] (ttHA)</b>: Motor torque overshooting high threshold <b>[High torque thd.] (ttH)</b> page 64.</li> <li><input type="checkbox"/> <b>[Low torque alarm] (ttLA)</b>: Motor torque undershooting low threshold <b>[Low torque thd.] (ttL)</b> page 64.</li> <li><input type="checkbox"/> <b>[Freq. meter Alarm] (FqLA)</b>: Measured speed threshold attained: <b>[Pulse warning thd.] (FqL)</b> page 65.</li> <li><input type="checkbox"/> <b>[Dynamic load alarm] (dLdA)</b>: Load variation detection (see <b>[DYNAMIC LOAD DETECT.] (dLd-)</b> page 230).</li> </ul> <p>See the multiple selection procedure on page 28 for the integrated display terminal, and page 19 for the graphic display terminal.</p> |                  |                 |
| <b>A2C-</b> | <b>[ALARM GRP2 DEFINITION]</b>   |                  |                 |
|             | Identical to <b>[ALARM GRP1 DEFINITION] (A1C-)</b>   |                  |                 |
| <b>A3C-</b> | <b>[ALARM GRP3 DEFINITION]</b>   |                  |                 |
|             | Identical to <b>[ALARM GRP1 DEFINITION] (A1C-)</b>   |                  |                 |



# [1.6 COMMAND] (CtL-)

With graphic display terminal:

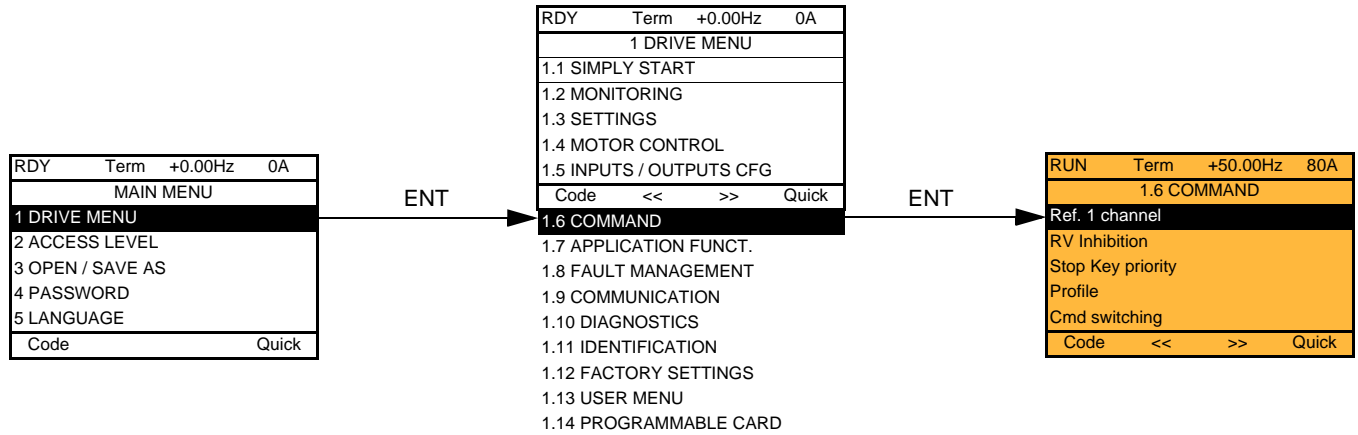

With integrated display terminal:

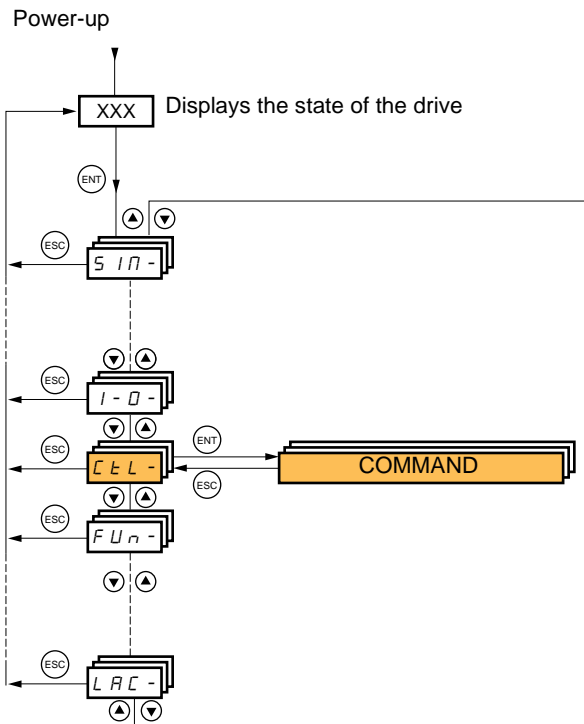

## [1.6 COMMAND] (CtL-)

The parameters in the [1.6 COMMAND] (CtL) menu can only be modified when the drive is stopped and no run command is present.

### Command and reference channels

Run commands (forward, reverse, stop, etc.) and references can be sent using the following channels:

| Control  | Reference  |
|--|--|
| <ul style="list-style-type: none"><li>• Terminals: logic inputs LI</li><li>• Graphic display terminal</li><li>• Integrated Modbus</li><li>• Integrated CANopen</li><li>• Communication card</li><li>• Controller Inside card</li></ul> | <ul style="list-style-type: none"><li>• Terminals: analog inputs AI, frequency input, encoder</li><li>• Graphic display terminal</li><li>• Integrated Modbus</li><li>• Integrated CANopen</li><li>• Communication card</li><li>• Controller Inside card</li><li>• +/- speed via the terminals</li><li>• +/- speed via the graphic display terminal</li></ul> |

#### The behavior of the Altivar 71 can be adapted according to requirements:

- [8 serie] (SE8): To replace an Altivar 58. See the Migration Manual.
- [Not separ.] (SIM): Command and reference are sent via the same channel.
- [Separate] (SEP): Command and reference may be sent via different channels.

In these configurations, control via the communication bus is performed in accordance with the DRIVECOM standard with only 5 freely-assignable bits (see Communication Parameters Manual). The application functions cannot be accessed via the communication interface.

- [I/O profile] (IO): The command and the reference can come from different channels. This configuration both simplifies and extends use via the communication interface.  
Commands may be sent via the logic inputs on the terminals or via the communication bus.  
When commands are sent via a bus, they are available on a word, which acts as virtual terminals containing only logic inputs.  
Application functions can be assigned to the bits in this word. More than one function can be assigned to the same bit.



**Note:** Stop commands from the terminals remain active even if the terminals are not the active command channel.



**Note :** The integrated Modbus channel has 2 physical communication ports:

- The Modbus network port
- The Modbus HMI port

The drive does not differentiate between these two ports, but recognizes the graphic display terminal irrespective of the port to which it is connected.

## [1.6 COMMAND] (CtL-)

### Reference channel for [Not separ.] (SIM), [Separate] (SEP) and [I/O profile] (IO) configurations, PID not configured

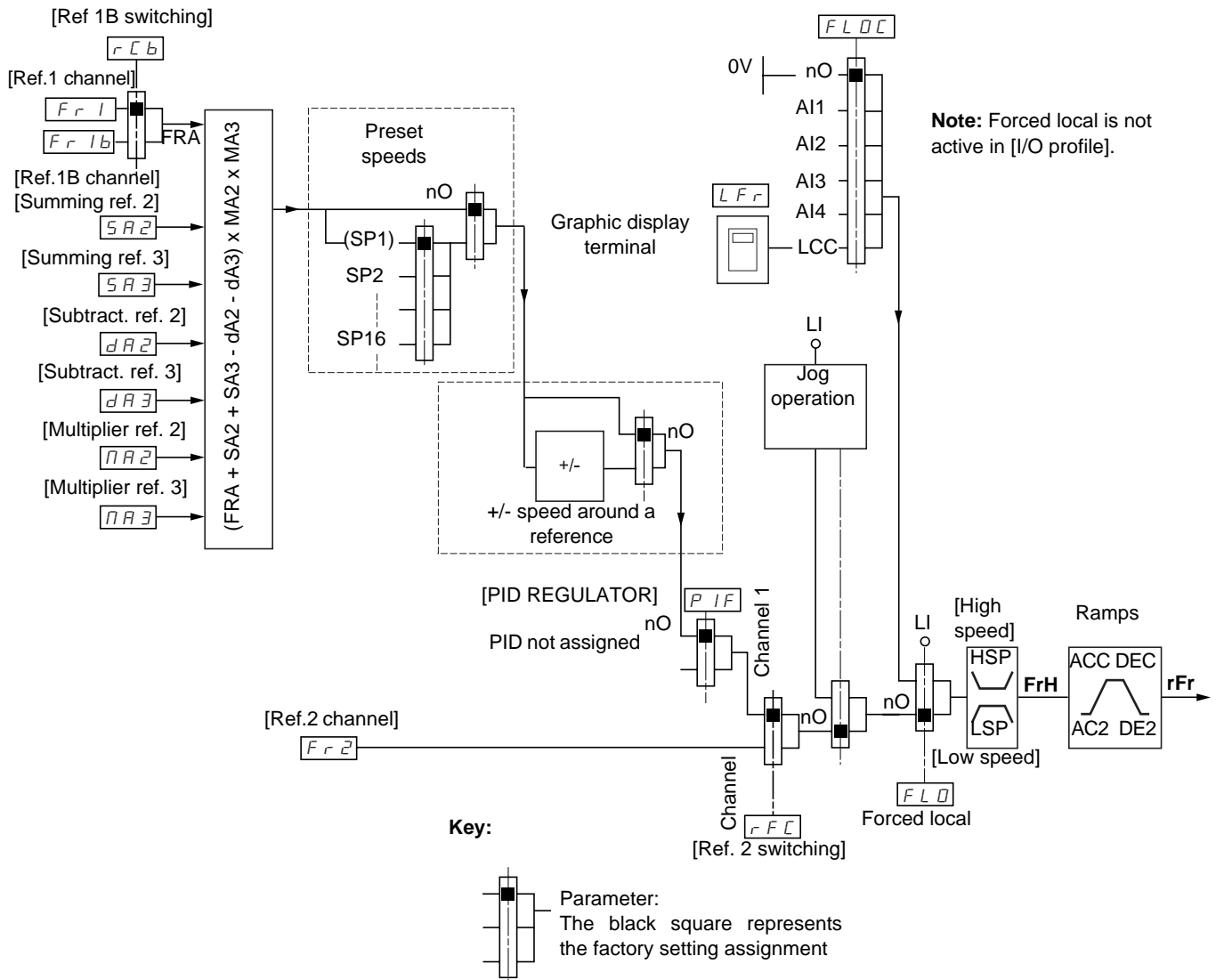

#### Instructions

##### Fr1, SA2, SA3, dA2, dA3, MA2, MA3:

- Terminals, graphic display terminal, integrated Modbus, integrated CANopen, communication card, Controller Inside card

##### Fr1b, for SEP and IO:

- Terminals, graphic display terminal, integrated Modbus, integrated CANopen, communication card, Controller Inside card

##### Fr1b, for SIM:

- Terminals, only accessible if Fr1 = terminals

##### Fr2:

- Terminals, graphic display terminal, integrated Modbus, integrated CANopen, communication card, Controller Inside card, **and +/- speed**

**Note :** [Ref.1B channel] (Fr1b) and [Ref 1B switching] (rCb) must be configured in the [1.7 APPLICATION FUNCT.] (Fun-) menu.

## [1.6 COMMAND] (CtL-)

### Reference channel for [Not separ.] (SIM), [Separate] (SEP) and [I/O profile] (IO) configurations, PID configured with PID references at the terminals

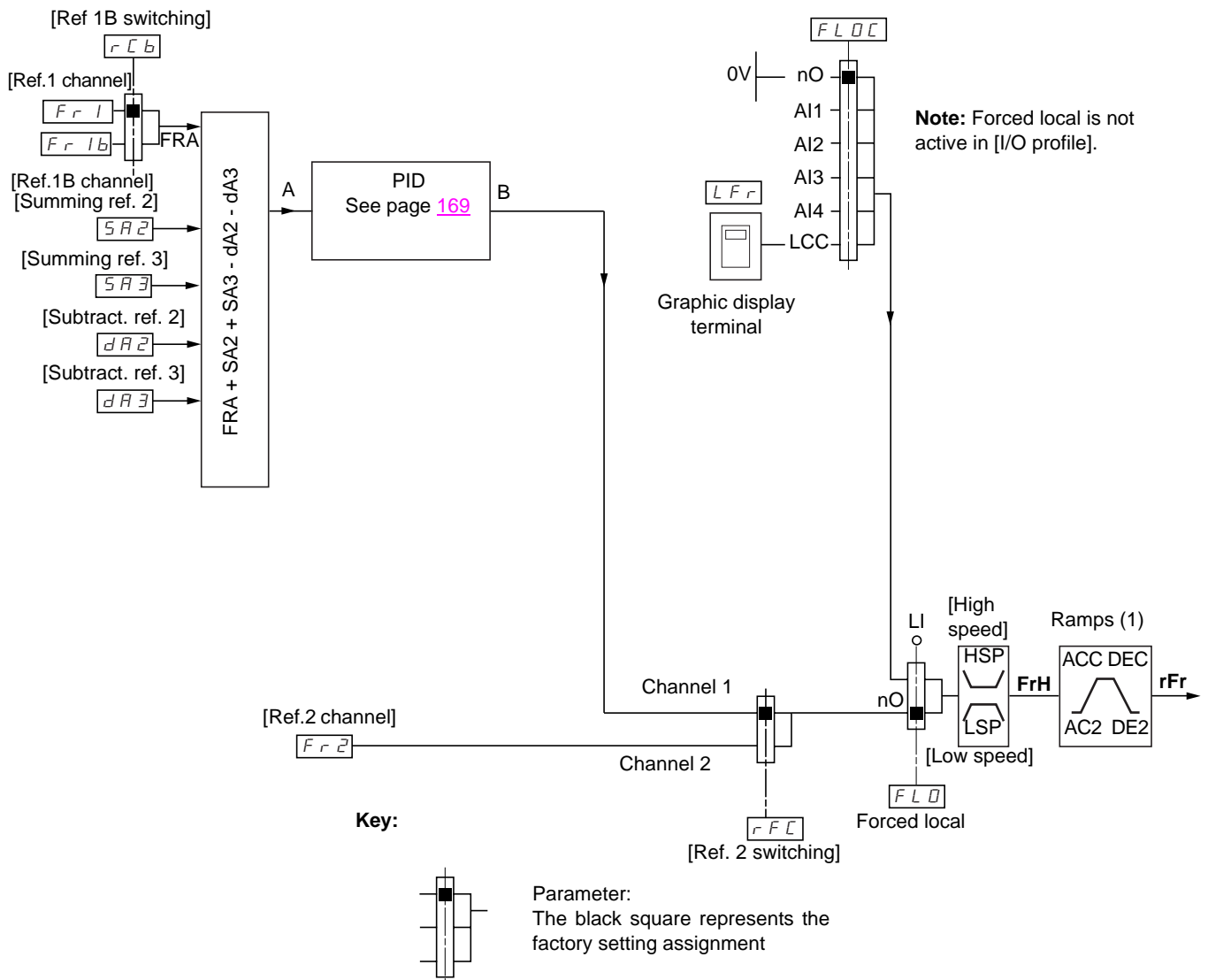

### Instructions

#### Fr1:

- Terminals, graphic display terminal, integrated Modbus, integrated CANopen, communication card, Controller Inside card

#### Fr1b, for SEP and IO:

- Terminals, graphic display terminal, integrated Modbus, integrated CANopen, communication card, Controller Inside card

#### Fr1b, for SIM:

- Terminals, only accessible if Fr1 = terminals

#### SA2, SA3, dA2, dA3:

- Terminals only

#### Fr2:

- Terminals, graphic display terminal, integrated Modbus, integrated CANopen, communication card, Controller Inside card, **and +/- speed**

(1) Ramps not active if the PID function is active in automatic mode.

**Note :** [Ref.1B channel] (Fr1b) and [Ref 1B switching] (rCb) must be configured in the [1.7 APPLICATION FUNCT.] (Fun-) menu.

# [1.6 COMMAND] (CtL-)

## Command channel for [Not separ.] (SIM) configuration

### Reference and command, not separate

The command channel is determined by the reference channel. Parameters Fr1, Fr2, rFC, FLO and FLOC are common to reference and command.

Example: if the reference is Fr1 = AI1 (analog input at the terminals), control is via LI (logic input at the terminals).

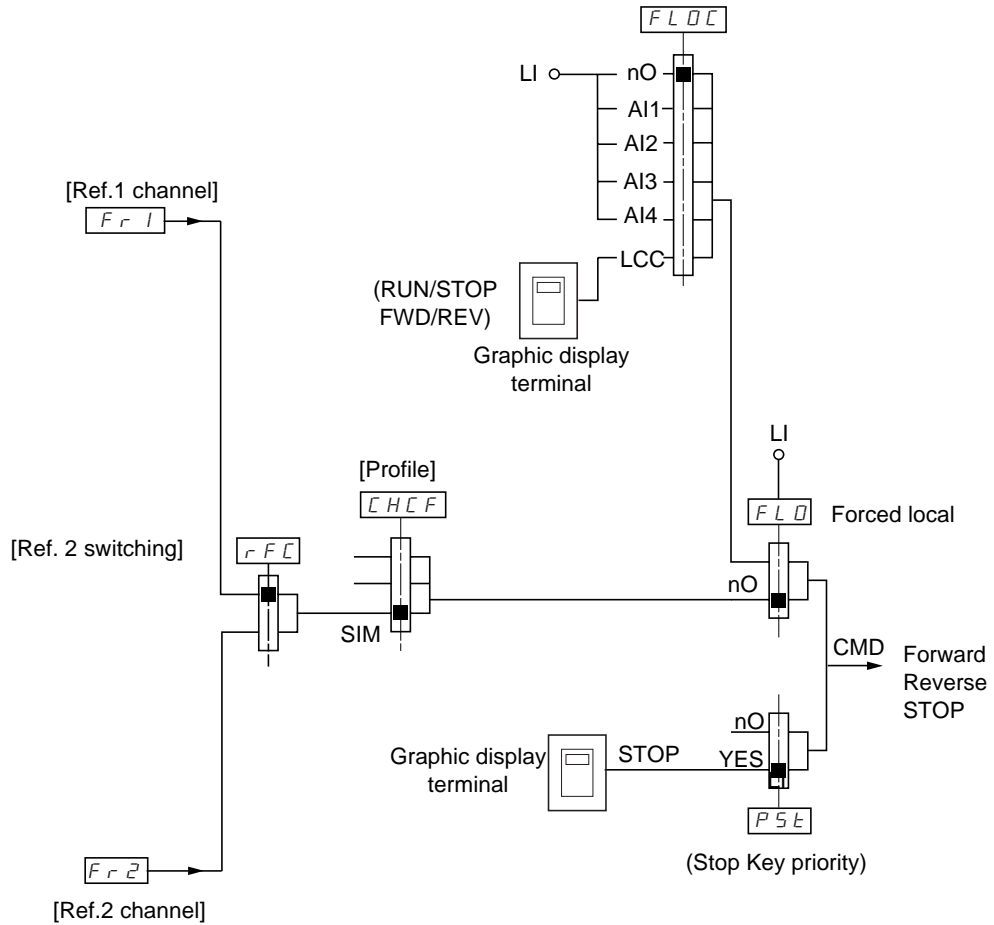

**Key:**

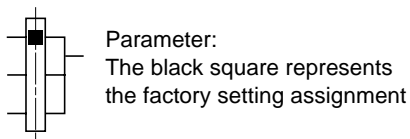

## [1.6 COMMAND] (CtL-)

### Command channel for [Separate] (SEP) configuration

#### Separate reference and command

Parameters FLO and FLOC are common to reference and command.

**Example: If the reference is in forced local mode via AI1 (analog input at the terminals), command in forced local mode is via LI (logic input at the terminals).**

The command channels Cd1 and Cd2 are independent of the reference channels Fr1, Fr1b and Fr2.

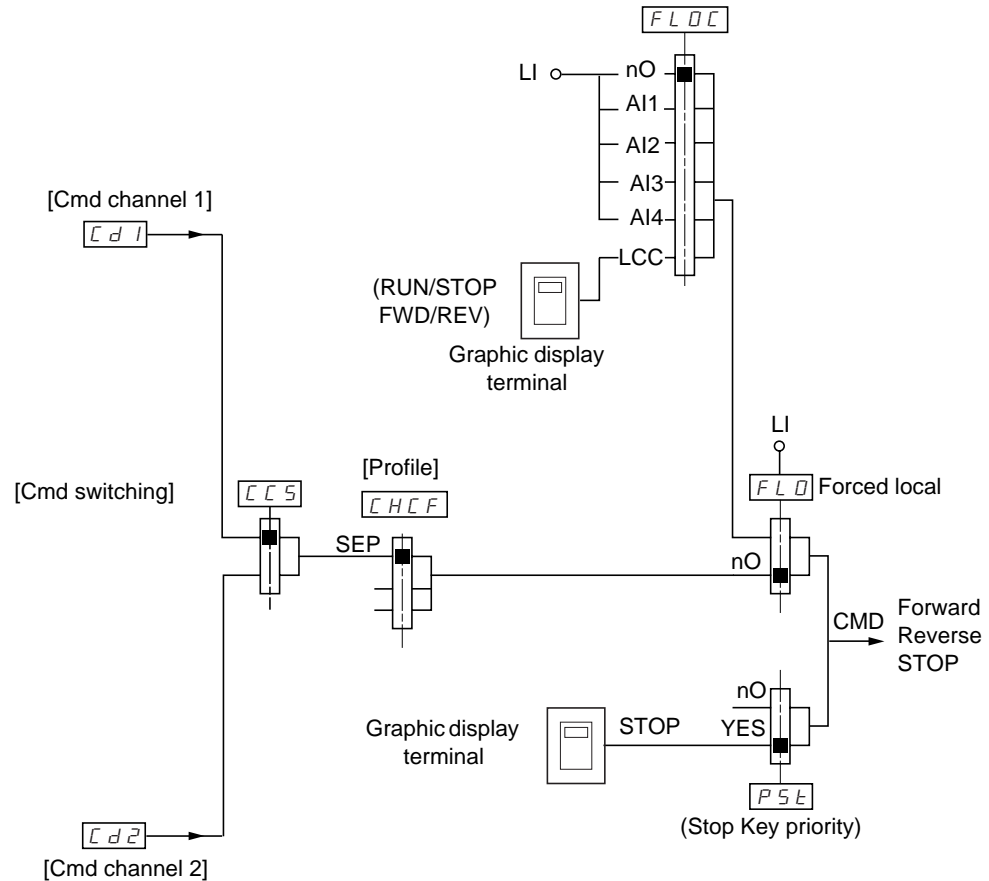

Key:

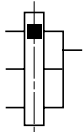

Parameter:  
The black rectangle represents the factory setting assignment, except for [Profile].

#### Commands

##### Cd1, Cd2:

- Terminals, graphic display terminal, integrated Modbus, integrated CANopen, communication card, Controller Inside card

## [1.6 COMMAND] (CtL-)

### Command channel for [I/O profile] (IO) configuration

#### Separate reference and command, as in [Separate] (SEP) configuration

The command channels Cd1 and Cd2 are independent of the reference channels Fr1, Fr1b and Fr2.

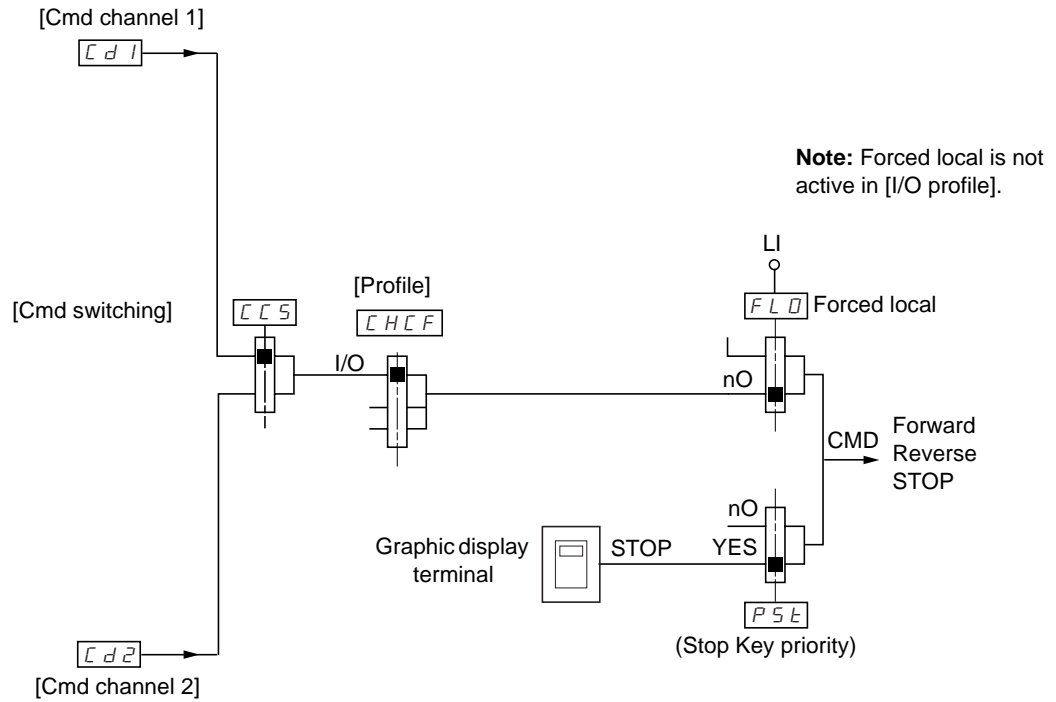

#### Key:

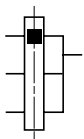

Parameter:  
The black rectangle represents the factory setting assignment, except for [Profile].

### Commands

#### Cd1, Cd2:

- Terminals, graphic display terminal, integrated Modbus, integrated CANopen, communication card, Controller Inside card

## [1.6 COMMAND] (CtL-)

### Command channel for [I/O profile] (IO) configuration

#### Selection of a command channel:

A command or an action can be assigned:

- To a fixed channel by selecting an LI input or a Cxxx bit:
  - By selecting e.g., LI3, this action will always be triggered by LI3 regardless of which command channel is switched.
  - By selecting e.g., C214, this action will always be triggered by integrated CANopen with bit 14 regardless of which command channel is switched.
- To a switchable channel by selecting a CDxx bit:
  - By selecting, e.g., CD11, this action will be triggered by
    - LI12 if the terminals channel is active
    - C111 if the integrated Modbus channel is active
    - C211 if the integrated CANopen channel is active
    - C311 if the communication card channel is active
    - C411 if the Controller Inside card channel is active

If the active channel is the graphic display terminal, the functions and commands assigned to CDxx switchable internal bits are inactive.

#### Note:

- CD14 and CD15 can only be used for switching between 2 networks. They do not have equivalent logic inputs.

| Terminals | Integrated Modbus | Integrated CANopen | Communication card | Controller Inside card | Internal bit, can be switched |
|-----------|-------------------|--------------------|--------------------|------------------------|-------------------------------|
|           |                   |                    |                    |                        | CD00                          |
| LI2 (1)   | C101 (1)          | C201 (1)           | C301 (1)           | C401 (1)               | CD01                          |
| LI3       | C102              | C202               | C302               | C402                   | CD02                          |
| LI4       | C103              | C203               | C303               | C403                   | CD03                          |
| LI5       | C104              | C204               | C304               | C404                   | CD04                          |
| LI6       | C105              | C205               | C305               | C405                   | CD05                          |
| LI7       | C106              | C206               | C306               | C406                   | CD06                          |
| LI8       | C107              | C207               | C307               | C407                   | CD07                          |
| LI9       | C108              | C208               | C308               | C408                   | CD08                          |
| LI10      | C109              | C209               | C309               | C409                   | CD09                          |
| LI11      | C110              | C210               | C310               | C410                   | CD10                          |
| LI12      | C111              | C211               | C311               | C411                   | CD11                          |
| LI13      | C112              | C212               | C312               | C412                   | CD12                          |
| LI14      | C113              | C213               | C313               | C413                   | CD13                          |
| -         | C114              | C214               | C314               | C414                   | CD14                          |
| -         | C115              | C215               | C315               | C415                   | CD15                          |

(1) If [2/3 wire control] (tCC) page 86 = [3 wire] (3C), LI2, C101, C201, C301, and C401 cannot be accessed.



## [1.6 COMMAND] (CtL-)

### Assignment conditions for logic inputs and control bits

The following elements are available for every command or function that can be assigned to a logic input or a control bit:

|                                      |   |
|--------------------------------------|---|
| [L11] (LI1)<br>to<br>[L16] (LI6)     | Drive with or without option                                    |
| [L17] (LI7)<br>to<br>[L110] (LI10)   | With VW3A3201 logic I/O card                                    |
| [L111] (LI11)<br>to<br>[L114] (LI14) | With VW3A3202 extended I/O card                                 |
| [C101] (C101)<br>to<br>[C110] (C110) | With integrated Modbus in [I/O profile] (IO) configuration      |
| [C111] (C111)<br>to<br>[C115] (C115) | With integrated Modbus regardless of configuration              |
| [C201] (C201)<br>to<br>[C210] (C210) | With integrated CANopen in [I/O profile] (IO) configuration     |
| [C211] (C211)<br>to<br>[C215] (C215) | With integrated CANopen regardless of configuration             |
| [C301] (C301)<br>to<br>[C310] (C310) | With a communication card in [I/O profile] (IO) configuration   |
| [C311] (C311)<br>to<br>[C315] (C315) | With a communication card regardless of configuration           |
| [C401] (C401)<br>to<br>[C410] (C410) | With Controller Inside card in [I/O profile] (IO) configuration |
| [C411] (C411)<br>to<br>[C415] (C415) | With Controller Inside card regardless of configuration         |
| [CD00] (Cd00)<br>to<br>[CD10] (Cd10) | In [I/O profile] (IO) configuration                             |
| [CD11] (Cd11)<br>to<br>[CD15] (Cd15) | Regardless of configuration                                     |

 **Note** : In [I/O profile] (IO) configuration, LI1 cannot be accessed and if [2/3 wire control] (tCC) page 86 = [3 wire] (3C), LI2, C101, C201, C301 and C401 cannot be accessed either.

### WARNING

#### UNINTENDED EQUIPMENT OPERATION

Inactive communication channels are not monitored (no lock following malfunction in the event of a communication bus failure). Make sure that the commands and functions assigned to bits C101 to C415 will not pose a risk in the event of the failure of the associated communication bus.

**Failure to follow these instructions can result in death or serious injury.**

## [1.6 COMMAND] (CtL-)

| Code   | Name/Description   | Adjustment range | Factory setting           |
|--|--|------------------|---------------------------|
| <b>Fr I</b><br>A I 1<br>A I 2<br>A I 3<br>A I 4<br>L C C<br>M d b<br>C A n<br>n E t<br>A P P<br>P I<br>P G | <input type="checkbox"/> <b>[Ref.1 channel]</b><br><input type="checkbox"/> <b>[AI1]</b> (AI1): Analog input<br><input type="checkbox"/> <b>[AI2]</b> (AI2): Analog input<br><input type="checkbox"/> <b>[AI3]</b> (AI3): Analog input, if VW3A3202 extension card has been inserted<br><input type="checkbox"/> <b>[AI4]</b> (AI4): Analog input, if VW3A3202 extension card has been inserted<br><input type="checkbox"/> <b>[HMI]</b> (LCC): Graphic display terminal<br><input type="checkbox"/> <b>[Modbus]</b> (Mdb): Integrated Modbus<br><input type="checkbox"/> <b>[CANopen]</b> (CA n): Integrated CANopen<br><input type="checkbox"/> <b>[Com. card]</b> (nEt): Communication card (if inserted)<br><input type="checkbox"/> <b>[C.Insid. card]</b> (APP): Controller Inside card (if inserted)<br><input type="checkbox"/> <b>[RP]</b> (PI): Frequency input, if VW3A3202 extension card has been inserted,<br><input type="checkbox"/> <b>[Encoder]</b> (PG): Encoder input, if encoder card has been inserted   |                  | <b>[AI1]</b> (AI1)        |
| <b>r In</b><br>n O<br>Y E S  | <input type="checkbox"/> <b>[RV Inhibition]</b><br><input type="checkbox"/> <b>[No]</b> (nO)<br><input type="checkbox"/> <b>[Yes]</b> (YES)<br>Inhibition of movement in reverse direction, does not apply to direction requests sent by logic inputs. <ul style="list-style-type: none"> <li>- Reverse direction requests sent by logic inputs are taken into account.</li> <li>- Reverse direction requests sent by the graphic display terminal are not taken into account.</li> <li>- Reverse direction requests sent by the line are not taken into account.</li> <li>- Any reverse speed reference originating from the PID, summing input, etc., is interpreted as a zero reference.</li> </ul>   |                  | <b>[No]</b> (nO)          |
| <b>PSt</b><br>n O<br>Y E S   | <input type="checkbox"/> <b>[Stop Key priority]</b><br><input type="checkbox"/> <b>[No]</b> (nO)<br><input type="checkbox"/> <b>[Yes]</b> (YES): Gives priority to the STOP key on the graphic display terminal when the graphic display terminal is not enabled as the command channel.<br>Press and hold down ENT for 2 seconds in order for any change in the assignment of <b>[Stop Key priority]</b> (PSt) to be taken into account.<br>This will be a freewheel stop. If the active command channel is the graphic display terminal, the stop will be performed according to the <b>[Type of stop]</b> (Stt) page 137 irrespective of the configuration of <b>[Stop Key priority]</b> (PSt).   |                  | <b>[Yes]</b> (YES)        |
| <b>CHCF</b><br>SEB<br>S I n<br>SEP<br>I O  | <input type="checkbox"/> <b>[Profile]</b><br><input type="checkbox"/> <b>[8 serie]</b> (SE8): ATV58 interchangeability (see Migration Manual). The <b>[8 serie]</b> (SE8) configuration is used to load, via PowerSuite, for example, an ATV58 drive configuration in an ATV71 that has already been set to this configuration. This assignment cannot be accessed if a Controller Inside card has been inserted.<br> <b>Note:</b> Modifications to the configuration of the ATV71 must only be made using PowerSuite when it is in this configuration, otherwise operation cannot be guaranteed.<br><input type="checkbox"/> <b>[Not separ.]</b> (SIM): Reference and command, not separate<br><input type="checkbox"/> <b>[Separate]</b> (SEP): Separate reference and command. This assignment cannot be accessed in <b>[I/O profile]</b> (IO).<br><input type="checkbox"/> <b>[I/O profile]</b> (IO): I/O profile<br>When <b>[8 serie]</b> (SE8) is selected and <b>[I/O profile]</b> (IO) is deselected, the drive automatically returns to the factory setting (this is mandatory). This factory setting only affects the [1 DRIVE MENU] menu. It does not affect either [1.9 COMMUNICATION] or [1.5 PROGRAMMABLE CARD]. <ul style="list-style-type: none"> <li>- With the graphic display terminal, a screen appears to perform this operation. Follow the instructions on the screen.</li> <li>- With the integrated display terminal, press ENT and hold it down (for 2 s). This will save the selection and return to the factory setting.</li> </ul> |                  | <b>[Not separ.]</b> (SIM) |

## [1.6 COMMAND] (CtL-)

| Code   | Name/Description  | Adjustment range | Factory setting    |
|--|---|------------------|--------------------|
| <b>CC5</b><br><br><b>Cd1</b><br><b>Cd2</b><br><br><b>LI1</b><br>-<br>-<br>-  | <input type="checkbox"/> <b>[Cmd switching]</b><br><br>The parameter can be accessed if [Profile] (CHCF) = [Separate] (SEP) or [I/O profile] (IO)<br><input type="checkbox"/> <b>[ch1 active]</b> (Cd1): [Cmd channel 1] (Cd1) active (no switching)<br><input type="checkbox"/> <b>[ch2 active]</b> (Cd2): [Cmd channel 2] (Cd2) active (no switching)<br><br><input type="checkbox"/> <b>[LI1]</b> (LI1)<br>:<br>:<br><input type="checkbox"/> <b>[...]</b> (...): See the assignment conditions on page 121 (not CDOO to CD14).<br><br>If the assigned input or bit is at 0, channel [Cmd channel 1] (Cd1) is active.<br>If the assigned input or bit is at 1, channel [Cmd channel 2] (Cd2) is active.  |                  | [ch1 active] (Cd1) |
| <b>Cd1</b><br><br><b>tEr</b><br><b>LCC</b><br><b>Mdb</b><br><b>CAn</b><br><b>nEt</b><br><b>APP</b>   | <input type="checkbox"/> <b>[Cmd channel 1]</b><br><br><input type="checkbox"/> <b>[Terminals]</b> (tEr): Terminals<br><input type="checkbox"/> <b>[HMI]</b> (LCC): Graphic display terminal<br><input type="checkbox"/> <b>[Modbus]</b> (Mdb): Integrated Modbus<br><input type="checkbox"/> <b>[CANopen]</b> (CAn): Integrated CANopen<br><input type="checkbox"/> <b>[Com. card]</b> (nEt): Communication card (if inserted)<br><input type="checkbox"/> <b>[C.Insid. card]</b> (APP): Controller Inside card (if inserted)<br>The parameter is available if [Profile] (CHCF) = [Separate] (SEP) or [I/O profile] (IO).  |                  | [Terminals] (tEr)  |
| <b>Cd2</b><br><br><b>tEr</b><br><b>LCC</b><br><b>Mdb</b><br><b>CAn</b><br><b>nEt</b><br><b>APP</b>   | <input type="checkbox"/> <b>[Cmd channel 2]</b><br><br><input type="checkbox"/> <b>[Terminals]</b> (tEr): Terminals<br><input type="checkbox"/> <b>[HMI]</b> (LCC): Graphic display terminal<br><input type="checkbox"/> <b>[Modbus]</b> (Mdb): Integrated Modbus<br><input type="checkbox"/> <b>[CANopen]</b> (CAn): Integrated CANopen<br><input type="checkbox"/> <b>[Com. card]</b> (nEt): Communication card (if inserted)<br><input type="checkbox"/> <b>[C.Insid. card]</b> (APP): Controller Inside card (if inserted)<br>The parameter is available if [Profile] (CHCF) = [Separate] (SEP) or [I/O profile] (IO).  |                  | [Modbus] (Mdb)     |
| <b>rFC</b><br><br><b>Fr1</b><br><b>Fr2</b><br><b>LI1</b><br>-<br>-<br>-  | <input type="checkbox"/> <b>[Ref. 2 switching]</b><br><br><input type="checkbox"/> <b>[ch1 active]</b> (Fr1): no switching, [Ref.1 channel] (Fr1) active<br><input type="checkbox"/> <b>[ch2 active]</b> (Fr2): no switching, [Ref.2 channel] (Fr2) active<br><input type="checkbox"/> <b>[LI1]</b> (LI1)<br>:<br>:<br><input type="checkbox"/> <b>[...]</b> (...): See the assignment conditions on page 121 (not CDOO to CD14).<br><br>If the assigned input or bit is at 0, channel [Ref.1 channel] (Fr1) is active.<br>If the assigned bit or input is at 1, channel [Ref.2 channel] (Fr2) is active.   |                  | [ch1 active] (Fr1) |
| <b>Fr2</b><br><br><b>nO</b><br><br><b>AI1</b><br><b>AI2</b><br><b>AI3</b><br><b>AI4</b><br><b>UPdt</b><br><b>LCC</b><br><b>Mdb</b><br><b>CAn</b><br><b>nEt</b><br><b>APP</b><br><b>PI</b><br><b>PG</b> | <input type="checkbox"/> <b>[Ref.2 channel]</b><br><br><input type="checkbox"/> <b>[No]</b> (nO): Not assigned. If [Profile] (CHCF) = [Not separ.] (SIM) the command is at the terminals with a zero reference. If [Profile] (CHCF) = [Separate] (SEP) or [I/O profile] (IO) the reference is zero.<br><input type="checkbox"/> <b>[AI1]</b> (AI1): Analog input<br><input type="checkbox"/> <b>[AI2]</b> (AI2): Analog input<br><input type="checkbox"/> <b>[AI3]</b> (AI3): Analog input, if VW3A3202 extension card has been inserted<br><input type="checkbox"/> <b>[AI4]</b> (AI4): Analog input, if VW3A3202 extension card has been inserted<br><input type="checkbox"/> <b>[+/- Speed]</b> (UPdt): +/- Speed command<br><input type="checkbox"/> <b>[HMI]</b> (LCC): Graphic display terminal<br><input type="checkbox"/> <b>[Modbus]</b> (Mdb): Integrated Modbus<br><input type="checkbox"/> <b>[CANopen]</b> (CAn): Integrated CANopen<br><input type="checkbox"/> <b>[Com. card]</b> (nEt): Communication card (if inserted)<br><input type="checkbox"/> <b>[C.Insid. card]</b> (APP): Controller Inside card (if inserted)<br><input type="checkbox"/> <b>[RP]</b> (PI): Frequency input, if VW3A3202 extension card has been inserted<br><input type="checkbox"/> <b>[Encoder]</b> (PG): Encoder input, if encoder card has been inserted |                  | [No] (nO)          |

## [1.6 COMMAND] (CtL-)

| Code  | Name/Description  | Adjustment range | Factory setting         |
|---|---|------------------|-------------------------|
| <p><b>C O P</b></p> <p><b>n O</b></p> <p><b>S P</b></p> <p><b>C d</b></p> <p><b>A L L</b></p> | <p><input type="checkbox"/> <b>[Copy channel 1 &lt;&gt; 2]</b></p> <p>Can be used to copy the current reference and/or the command by means of switching, in order to avoid speed surges, for example.</p> <p>If [Profile] (CHCF) page 122 = [Not separ.] (SIM) or [Separate] (SEP), copying will only be possible from channel 1 to channel 2.</p> <p>If [Profile] (CHCF) = [I/O profile] (IO), copying will be possible in both directions.</p> <p><input type="checkbox"/> <b>[No] (nO)</b>: No copy</p> <p><input type="checkbox"/> <b>[Reference] (SP)</b>: Copy reference</p> <p><input type="checkbox"/> <b>[Command] (Cd)</b>: Copy command</p> <p><input type="checkbox"/> <b>[Cmd + ref.] (ALL)</b>: Copy command and reference</p> <ul style="list-style-type: none"> <li>- A reference or a command cannot be copied to a channel on the terminals.</li> <li>- The reference copied is FrH (before ramp) unless the destination channel reference is set via +/- speed. In this case, the reference copied is rFr (after ramp).</li> </ul> <div style="border: 1px solid black; padding: 10px; margin-top: 20px;"> <p style="text-align: center;"> <b>WARNING</b></p> <p><b>UNINTENDED EQUIPMENT OPERATION</b></p> <p>Copying the command and/or reference can change the direction of rotation.<br/>Check that this is safe.</p> <p><b>Failure to follow these instructions can result in death or serious injury.</b></p> </div> |                  | <p><b>[No] (nO)</b></p> |

## [1.6 COMMAND] (CtL-)

As the graphic display terminal may be selected as the command and/or reference channel, its action modes can be configured. The parameters on this page can only be accessed on the graphic display terminal, and not on the integrated display terminal.

### Comments:

- The display terminal command/reference is only active if the command and/or reference channels from the terminal are active with the exception of **[T/K]** (command via the display terminal), which takes priority over these channels. Press **[T/K]** (command via the display terminal) again to revert control to the selected channel.
- Command and reference via the display terminal are impossible if the latter is connected to more than one drive.
- The JOG, preset speed and +/- speed functions can only be accessed if **[Profile] (CHCF) = [Not separ.] (SIM)**.
- The preset PID reference functions can only be accessed if **[Profile] (CHCF) = [Not separ.] (SIM)** or **[Separate] (SEP)**
- The **[T/K]** (command via the display terminal) can be accessed regardless of the **[Profile] (CHCF)**.

| Name/Description   | Adjustment range | Factory setting |
|--|------------------|-----------------|
| <input type="checkbox"/> <b>[F1 key assignment]</b><br><input type="checkbox"/> <b>[No]</b> : Not assigned<br><input type="checkbox"/> <b>[Jog]</b> : JOG operation<br><input type="checkbox"/> <b>[Preset spd2]</b> : Press the key to run the drive at the 2 <sup>nd</sup> preset speed <b>[Preset speed 2] (SP2)</b> page 144. Press STOP to stop the drive.<br><input type="checkbox"/> <b>[Preset spd3]</b> : Press the key to run the drive at the 3 <sup>rd</sup> preset speed <b>[Preset speed 3] (SP3)</b> page 144. Press STOP to stop the drive.<br><input type="checkbox"/> <b>[PID ref. 2]</b> : Sets a PID reference equal to the 2 <sup>nd</sup> preset PID reference <b>[Preset ref. PID 2] (rP2)</b> page 177, without sending a run command. Only operates if <b>[Ref.1 channel] (Fr1) = [HMI] (LCC)</b> . Does not operate with the <b>[T/K]</b> function.<br><input type="checkbox"/> <b>[PID ref. 3]</b> : Sets a PID reference equal to the 3 <sup>rd</sup> preset PID reference <b>[Preset ref. PID 3] (rP3)</b> page 177, without sending a run command. Only operates if <b>[Ref.1 channel] (Fr1) = [HMI] (LCC)</b> . Does not operate with the <b>[T/K]</b> function.<br><input type="checkbox"/> <b>[+speed]</b> : Faster, only operates if <b>[Ref.2 channel] (Fr2) = [HMI] (LCC)</b> . Press the key to run the drive and increase the speed. Press STOP to stop the drive.<br><input type="checkbox"/> <b>[- speed]</b> : Slower, only operates if <b>[Ref.2 channel] (Fr2) = [HMI] (LCC)</b> and if a different key has been assigned to <b>[+ speed]</b> . Press the key to run the drive and decrease the speed. Press STOP to stop the drive.<br><input type="checkbox"/> <b>[T/K]</b> : Command via the display terminal: takes priority over <b>[Cmd switching] (CCS)</b> and over <b>[Ref. 2 switching] (rFC)</b> . |                  | [No]            |
| <input type="checkbox"/> <b>[F2 key assignment]</b><br>Identical to <b>[F1 key assignment]</b> .   |                  | [No]            |
| <input type="checkbox"/> <b>[F3 key assignment]</b><br>Identical to <b>[F1 key assignment]</b> .   |                  | [No]            |
| <input type="checkbox"/> <b>[F4 key assignment]</b><br>Identical to <b>[F1 key assignment]</b> .   |                  | [No]            |
| <input type="checkbox"/> <b>[HMI cmd.]</b><br>When the <b>[T/K]</b> function is assigned to a key and that function is active, this parameter defines the behavior at the moment when control returns to the graphic display terminal.<br><input type="checkbox"/> <b>[Stop]</b> : Stops the drive (although the controlled direction of operation and reference of the previous channel are copied (to be taken into account on the next RUN command)).<br><input type="checkbox"/> <b>[Bumpless]</b> : Does not stop the drive (the controlled direction of operation and the reference of the previous channel are copied).   |                  | [Stop]          |

## [1.7 APPLICATION FUNCT.] (FUn-)

With graphic display terminal:

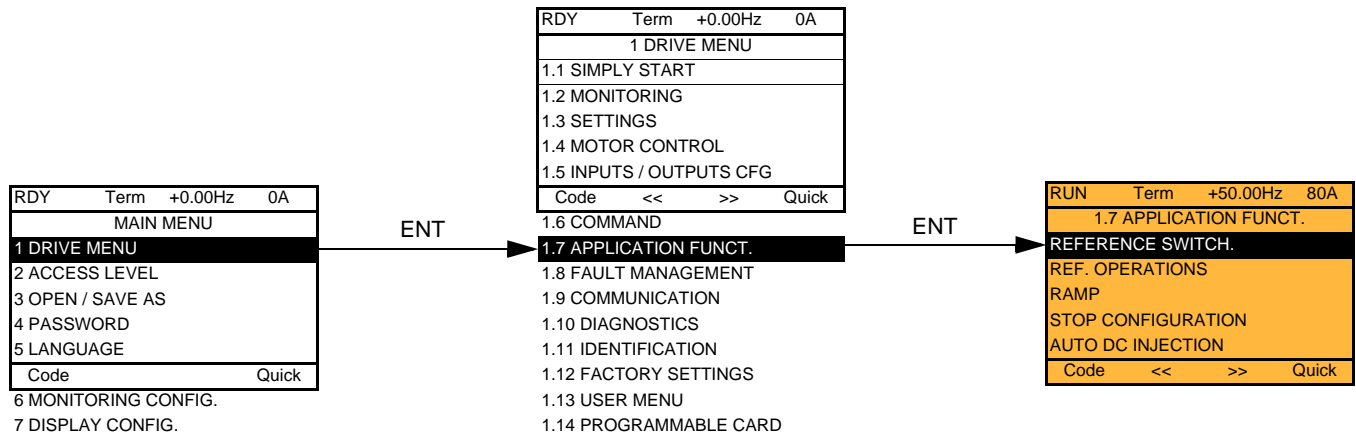

With integrated display terminal:

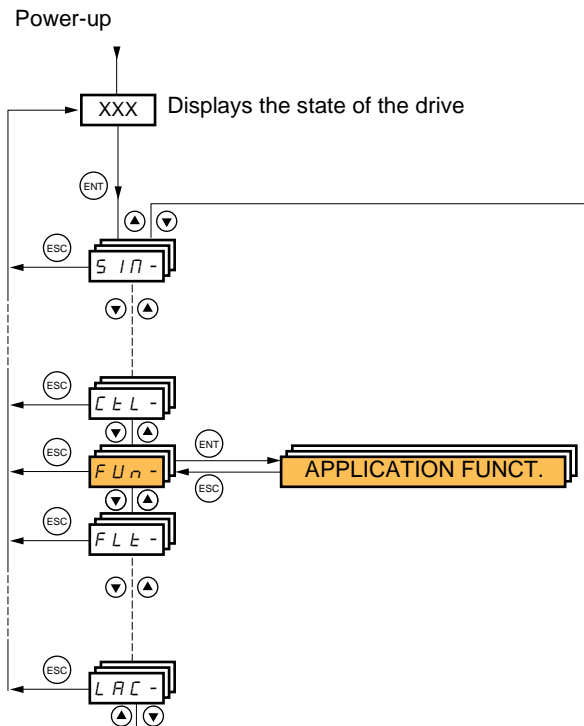

Summary of functions:

| Code | Name                     | Page |
|------|--------------------------|------|
| rEF- | [REFERENCE SWITCH.]      | 132  |
| DAI- | [REF. OPERATIONS]        | 133  |
| rPE- | [RAMP]                   | 134  |
| StE- | [STOP CONFIGURATION]     | 137  |
| AdC- | [AUTO DC INJECTION]      | 139  |
| JOg- | [JOG]                    | 141  |
| PSS- | [PRESET SPEEDS]          | 143  |
| UPd- | [+/- SPEED]              | 146  |
| SrE- | [+/-SPEED AROUND REF.]   | 148  |
| SPn- | [MEMO REFERENCE]         | 149  |
| FLI- | [FLUXING BY LI]          | 150  |
| LSt- | [LIMIT SWITCHES]         | 152  |
| bLC- | [BRAKE LOGIC CONTROL]    | 157  |
| ELn- | [EXTERNAL WEIGHT MEAS.]  | 163  |
| HSH- | [HIGH SPEED HOISTING]    | 168  |
| PId- | [PID REGULATOR]          | 173  |
| PrI- | [PID PRESET REFERENCES]  | 177  |
| tDr- | [TORQUE CONTROL]         | 179  |
| tDL- | [TORQUE LIMITATION]      | 182  |
| CLI- | [2nd CURRENT LIMIT.]     | 184  |
| LLC- | [LINE CONTACTOR COMMAND] | 186  |
| DCc- | [OUTPUT CONTACTOR CMD]   | 188  |
| LPO- | [POSITIONING BY SENSORS] | 192  |
| nLP- | [PARAM. SET SWITCHING]   | 195  |
| nnc- | [MULTIMOTORS/CONFIG.]    | 199  |
| tnL- | [AUTO TUNING BY LI]      | 199  |
| trD- | [TRAVERSE CONTROL]       | 205  |
| rFE- | [EVACUATION]             | 207  |
| HFF- | [HALF FLOOR]             | 208  |
| dCO- | [DC BUS SUPPLY]          | 209  |

## [1.7 APPLICATION FUNCT.] (FUn-)

---

The parameters in the [\[1.7 APPLICATION FUNCT.\] \(FUn-\)](#) menu can only be modified when the drive is stopped and there is no run command, except for parameters with a  symbol in the code column, which can be modified with the drive running or stopped.



### **Note: Compatibility of functions**

The choice of application functions may be limited by the number of I/O and by the fact that some functions are incompatible with one another. Functions that are not listed in the table below are fully compatible.

**If there is an incompatibility between functions, the first function configured will prevent the others being configured.**

Each of the functions on the following pages can be assigned to one of the inputs or outputs.

**A single input can activate several functions at the same time** (reverse and 2<sup>nd</sup> ramp for example), **The user must therefore ensure that these functions can be used at the same time.** It is only possible to assign one input to several functions at [\[Advanced\] \(AdU\)](#) and [\[Expert\] \(EPr\)](#) levels.

**Before assigning a command, reference or function to an input or output, the user must make sure that this input or output has not already been assigned and that another input or output has not been assigned to an incompatible or undesirable function.**

The drive factory setting or macro configurations automatically configure functions, **which may prevent other functions being assigned.** **It may be necessary to unconfigure one or more functions in order to be able to enable another.** Check the compatibility table below.

## Compatibility table

|   | Ref. operations (page 133) | +/- speed (3) (page 146) | Management of limit switches (page 152) | Preset speeds (page 143) | PID regulator (page 173) | Traverse control (page 205) | JOG operation (page 141) | Brake logic control (page 157) | Catch on the fly (page 215) |  | DC injection stop (page 137) | Fast stop (page 137) | Freewheel stop (page 137) | +/- speed around a reference (page 148) | High speed hoisting (page 168) | Torque control (page 179) | Load sharing (page 82) | Positioning by sensors (page 192) | Synchronous motor (page 74) |
|---|----------------------------|--------------------------|---|--------------------------|--------------------------|-----------------------------|--------------------------|--------------------------------|-----------------------------|--|------------------------------|----------------------|---------------------------|---|--------------------------------|---------------------------|------------------------|-----------------------------------|-----------------------------|
| Ref. operations (page 133)              |                            |                          |   | ↑                        | ●(4)                     |                             | ↑                        |                                |                             |  |                              |                      |                           |   |                                | ●(1)                      |                        |                                   |                             |
| +/- speed (3) (page 146)                |                            |                          |   |                          |                          | ●                           | ●                        |                                |                             |  |                              |                      |                           |   |                                | ●(1)                      |                        |                                   |                             |
| Management of limit switches (page 152) |                            |                          |   |                          | ●                        |                             |                          |                                |                             |  |                              |                      |                           |   |                                |                           |                        |                                   |                             |
| Preset speeds (page 143)                | ←                          |                          |   |                          |                          |                             | ↑                        |                                |                             |  |                              |                      |                           |   |                                | ●(1)                      |                        |                                   |                             |
| PID regulator (page 173)                | ●(4)                       |                          | ●                                       |                          |                          | ●                           | ●                        | ●                              |                             |  |                              |                      |                           | ●                                       | ●                              | ●(1)                      | ●                      | ●                                 |                             |
| Traverse control (page 205)             |                            | ●                        |   |                          | ●                        |                             | ●                        |                                |                             |  |                              |                      |                           | ●                                       | ●                              | ●(1)                      |                        |                                   |                             |
| JOG operation (page 141)                | ←                          | ●                        |   | ←                        | ●                        | ●                           |                          | ●                              |                             |  |                              |                      |                           | ●                                       | ●                              | ●(1)                      |                        |                                   |                             |
| Brake logic control (page 157)          |                            |                          |   |                          | ●                        |                             | ●                        |                                | ●                           |  | ●                            |                      |                           |   |                                | ●                         |                        |                                   | ●                           |
| Catch on the fly (page 215)             |                            |                          |   |                          |                          |                             |                          |                                | ●                           |  |                              |                      |                           |   |                                | ●(1)                      |                        |                                   |                             |
|   |                            |                          |   |                          |                          |                             |                          |                                |                             |  |                              |                      |                           |   |                                |                           |                        |                                   |                             |
| DC injection stop (page 137)            |                            |                          |   |                          |                          |                             |                          | ●                              |                             |  |                              | ●(2)                 | ↑                         |   |                                |                           |                        |                                   | ●                           |
| Fast stop (page 137)                    |                            |                          |   |                          |                          |                             |                          |                                |                             |  | ●(2)                         |                      | ↑                         |   |                                |                           |                        |                                   |                             |
| Freewheel stop (page 137)               |                            |                          |   |                          |                          |                             |                          |                                |                             |  | ←                            | ←                    |                           |   |                                |                           |                        |                                   |                             |
| +/- speed around a reference (page 148) |                            |                          |   |                          | ●                        | ●                           | ●                        |                                |                             |  |                              |                      |                           |   |                                | ●(1)                      |                        |                                   |                             |
| High speed hoisting (page 168)          |                            |                          |   |                          | ●                        | ●                           | ●                        |                                |                             |  |                              |                      |                           |   |                                | ●                         |                        | ●                                 |                             |
| Torque control (page 179)               | ●(1)                       | ●(1)                     | ●(1)                                    | ●(1)                     | ●(1)                     | ●(1)                        | ●(1)                     | ●                              | ●(1)                        |  |                              |                      |                           | ●(1)                                    | ●                              |                           | ●                      | ●(1)                              | ●                           |
| Load sharing (page 82)                  |                            |                          |   |                          | ●                        |                             |                          |                                |                             |  |                              |                      |                           |   |                                | ●                         |                        |                                   |                             |
| Positioning by sensors (page 192)       |                            |                          |   |                          | ●                        |                             |                          |                                |                             |  |                              |                      |                           | ●                                       | ●(1)                           |                           |                        |                                   |                             |
| Synchronous motor (page 74)             |                            |                          |   |                          |                          |                             |                          | ●                              |                             |  | ●                            |                      |                           |   |                                | ●                         |                        |                                   |                             |

(1) Torque control and these functions are only incompatible while torque control mode is active.

(2) Priority is given to the first of these two stop modes to be activated.

(3) Excluding special application with reference channel Fr2 (see diagrams on pages 115 and 116).

(4) Only the multiplier reference is incompatible with the PID regulator.

● Incompatible functions      □ Compatible functions      ■ Not applicable

Priority functions (functions, which cannot be active at the same time):

← ↑ The function indicated by the arrow has priority over the other.

Stop functions have priority over run commands.

Speed references via logic command have priority over analog references.

 **Note:** This compatibility table does not affect commands that can be assigned to the keys of the graphic display terminal (see page 125).



## [1.7 APPLICATION FUNCT.] (FUn-)

### Incompatible functions

The following functions will be inaccessible or deactivated in the cases described below:

#### Automatic restart

This is only possible for control type [2/3 wire control] (tCC) = [2 wire] (2C) and [2 wire type] (tCt) = [Level] (LEL) or [Fwd priority] (PFO). See page 86.

#### Catch a spinning load

This is only possible for control type [2/3 wire control] (tCC) = [2 wire] (2C) and [2 wire type] (tCt) = [Level] (LEL) or [Fwd priority] (PFO). See page 86.

This function is locked if automatic injection on stop [Auto DC injection] (AdC) = [Continuous] (Ct). See page 139.

The SUP- monitoring menu (page 43) can be used to display the functions assigned to each input in order to check their compatibility.

When a function is assigned, a ✓ appears on the graphic display terminal, as illustrated in the example below:

|                        |      |         |       |
|------------------------|------|---------|-------|
| RDY                    | Term | +0.00Hz | 0A    |
| 1.7 APPLICATION FUNCT. |      |         |       |
| REFERENCE SWITCH.      |      |         |       |
| REF. OPERATIONS        |      |         |       |
| RAMP                   |      |         |       |
| STOP CONFIGURATION     |      |         |       |
| AUTO DC INJECTION      |      |         |       |
| Code                   | <<   | >>      | Quick |
| JOG                    |      |         |       |

If you attempt to assign a function that is incompatible with another function that has already been assigned, an alarm message will appear:

With the graphic display terminal:

|                                   |      |         |    |
|-----------------------------------|------|---------|----|
| RDY                               | Term | +0.00Hz | 0A |
| INCOMPATIBILITY                   |      |         |    |
| The function can't be assigned    |      |         |    |
| because an incompatible           |      |         |    |
| function is already selected. See |      |         |    |
| programming book.                 |      |         |    |
| ENT or ESC to continue            |      |         |    |

With the integrated display terminal:

COMP flashes until ENT or ESC is pressed.

When you assign a logic input, an analog input, a reference channel or a bit to a function, pressing the HELP button will display the functions that may already have been activated by this input, bit or channel.

## [1.7 APPLICATION FUNCT.] (FUn-)

---

**When a logic input, an analog input, a reference channel or a bit that has already been assigned is assigned to another function, the following screens appear:**

**With the graphic display terminal:**

|                              |
|------------------------------|
| RUN +50.00Hz 1250A +50.00Hz  |
| WARNING - ASSIGNED TO        |
| Ref. 2 switching             |
| ENT->Continue    ESC->Cancel |

If the access level permits this new assignment, pressing ENT confirms the assignment.

If the access level does not permit this new assignment, pressing ENT results in the following display:

|  |
|--|
| RUN +50.00Hz 1250A +50.00Hz  |
| ASSIGNMENT FORBIDDEN   |
| Un-assign the present<br>functions, or select<br>Advanced access level |
|  |

**With the integrated display terminal:**

The code for the first function, which is already assigned, is displayed flashing.

If the access level permits this new assignment, pressing ENT confirms the assignment.

If the access level does not permit this new assignment, pressing ENT has no effect, and the message continues to flash. It is only possible to exit by pressing ESC.

### Summing input/Subtracting input/Multiplier

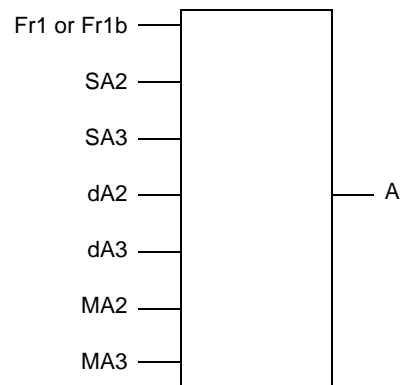

$$A = (\text{Fr1 or Fr1b} + \text{SA2} + \text{SA3} - \text{dA2} - \text{dA3}) \times \text{MA2} \times \text{MA3}$$

- If SA2, SA3, dA2, dA3 are not assigned, they are set to 0.
- If MA2, MA3 are not assigned, they are set to 1.
- A is limited by the minimum LSP and maximum HSP parameters.
- For multiplication, the signal on MA2 or MA3 is interpreted as a %; 100% corresponds to the maximum value of the corresponding input. If MA2 or MA3 is sent via the communication bus or graphic display terminal, an MFr multiplication variable, page 49 must be sent via the bus or graphic display terminal.
- Reversal of the direction of operation in the event of a negative result can be inhibited (see page 122).

# [1.7 APPLICATION FUNCT.] (FUn-)

| Code        | Name/Description   | Adjustment range | Factory setting           |
|-------------|--|------------------|---------------------------|
| <b>rEF-</b> | <b>■ [REFERENCE SWITCH.]</b>   |                  |                           |
| <b>rCb</b>  | <input type="checkbox"/> <b>[Ref 1B switching]</b><br>See the diagrams on pages <a href="#">115</a> and <a href="#">116</a> .  |                  | <b>[ch1 active] (Fr1)</b> |
| <b>Fr1</b>  | <input type="checkbox"/> <b>[ch1 active] (Fr1)</b> : no switching, <b>[Ref.1 channel] (Fr1)</b> active   |                  |                           |
| <b>Fr1b</b> | <input type="checkbox"/> <b>[ch1B active] (Fr1b)</b> : no switching, <b>[Ref.1B channel] (Fr1b)</b> active   |                  |                           |
| <b>L11</b>  | <input type="checkbox"/> <b>[LI1] (LI1)</b>  |                  |                           |
| -           | ⋮  |                  |                           |
| -           | ⋮  |                  |                           |
| -           | <input type="checkbox"/> <b>[...] (...)</b> : See the assignment conditions on page <a href="#">121</a> (not CDOO to CD14).  |                  |                           |
|             | <ul style="list-style-type: none"> <li>• If the assigned input or bit is at 0, <b>[Ref.1 channel] (Fr1)</b> is active (see page <a href="#">122</a>).</li> <li>• If the assigned input or bit is at 1, <b>[Ref.1B channel] (Fr1b)</b> is active.</li> </ul>  |                  |                           |
|             | <b>[Ref 1B switching] (rCb)</b> is forced to <b>[ch1 active] (Fr1)</b> if <b>[Profile] (CHCF)</b> = <b>[Not separ.] (SIM)</b> with <b>[Ref.1 channel] (Fr1)</b> assigned via the terminals (analog inputs, encoder, pulse input); see page <a href="#">122</a> .   |                  |                           |
| <b>Fr1b</b> | <input type="checkbox"/> <b>[Ref.1B channel]</b>   |                  | <b>[No] (nO)</b>          |
| <b>nO</b>   | <input type="checkbox"/> <b>[No] (nO)</b> : Not assigned   |                  |                           |
| <b>A11</b>  | <input type="checkbox"/> <b>[AI1] (AI1)</b> : Analog input   |                  |                           |
| <b>A12</b>  | <input type="checkbox"/> <b>[AI2] (AI2)</b> : Analog input   |                  |                           |
| <b>A13</b>  | <input type="checkbox"/> <b>[AI3] (AI3)</b> : Analog input, if VW3A3202 extension card has been inserted   |                  |                           |
| <b>A14</b>  | <input type="checkbox"/> <b>[AI4] (AI4)</b> : Analog input, if VW3A3202 extension card has been inserted   |                  |                           |
| <b>LCC</b>  | <input type="checkbox"/> <b>[HMI] (LCC)</b> : Graphic display terminal   |                  |                           |
| <b>Modb</b> | <input type="checkbox"/> <b>[Modbus] (Mdb)</b> : Integrated Modbus   |                  |                           |
| <b>CAn</b>  | <input type="checkbox"/> <b>[CANopen] (CAn)</b> : Integrated CANopen   |                  |                           |
| <b>nEt</b>  | <input type="checkbox"/> <b>[Com. card] (nEt)</b> : Communication card (if inserted)   |                  |                           |
| <b>APP</b>  | <input type="checkbox"/> <b>[C.Insid. card] (APP)</b> : Controller Inside card (if inserted)   |                  |                           |
| <b>PI</b>   | <input type="checkbox"/> <b>[RP] (PI)</b> : Frequency input, if VW3A3202 extension card has been inserted  |                  |                           |
| <b>PG</b>   | <input type="checkbox"/> <b>[Encoder] (PG)</b> : Encoder input, if encoder card has been inserted  |                  |                           |
|             | <b>Note:</b><br>In the following instances, only assignments via the terminals are possible: <ul style="list-style-type: none"> <li>- <b>[Profile] (CHCF)</b> = <b>[Not separ.] (SIM)</b> with <b>[Ref.1 channel] (Fr1)</b> assigned via the terminals (analog inputs, encoder, pulse input); see page <a href="#">122</a>.</li> <li>- PID configured with PID references via the terminals</li> </ul> |                  |                           |

# [1.7 APPLICATION FUNCT.] (FUn-)

| Code   | Name/Description   | Adjustment range | Factory setting |
|--|--|------------------|-----------------|
| <b>0A1-</b>  | <div style="background-color: #00FFFF; padding: 5px;"> <p><b>■ [REF. OPERATIONS]</b></p> <p>Reference = (Fr1 or Fr1b + SA2 + SA3 - dA2 - dA3) x MA2 x MA3. See the diagrams on pages <a href="#">115</a> and <a href="#">116</a>.</p> <p> <b>Note:</b> This function cannot be used with certain other functions. Follow the instructions on page <a href="#">127</a>.</p> </div>  |                  |                 |
| <b>SA2</b>   | <input type="checkbox"/> <b>[Summing ref. 2]</b>   |                  | [No] (nO)       |
| nO<br>A11<br>A12<br>A13<br>A14<br>LCC<br>Mdb<br>CAn<br>nEt<br>APP<br>PI<br>PG<br>AIU1  | <p>Selection of a reference to be added to [Ref.1 channel] (Fr1) or [Ref.1B channel] (Fr1b).</p> <ul style="list-style-type: none"> <li><input type="checkbox"/> <b>[No]</b> (nO): No source assigned</li> <li><input type="checkbox"/> <b>[AI1]</b> (AI1): Analog input</li> <li><input type="checkbox"/> <b>[AI2]</b> (AI2): Analog input</li> <li><input type="checkbox"/> <b>[AI3]</b> (AI3): Analog input, if VW3A3202 extension card has been inserted</li> <li><input type="checkbox"/> <b>[AI4]</b> (AI4): Analog input, if VW3A3202 extension card has been inserted</li> <li><input type="checkbox"/> <b>[HMI]</b> (LCC): Graphic display terminal</li> <li><input type="checkbox"/> <b>[Modbus]</b> (Mdb): Integrated Modbus</li> <li><input type="checkbox"/> <b>[CANopen]</b> (CAn): Integrated CANopen</li> <li><input type="checkbox"/> <b>[Com. card]</b> (nEt): Communication card (if inserted)</li> <li><input type="checkbox"/> <b>[C.Insid. card]</b> (APP): Controller Inside card (if inserted)</li> <li><input type="checkbox"/> <b>[RP]</b> (PI): Frequency input, if VW3A3202 extension card has been inserted</li> <li><input type="checkbox"/> <b>[Encoder]</b> (PG): Encoder input, if encoder card has been inserted</li> <li><input type="checkbox"/> <b>[Network AI]</b> (AIU1): Virtual input via communication bus, can be configured using [AI net. channel] (AIC1) page <a href="#">95</a>.</li> </ul> |                  |                 |
| <div style="border: 1px solid black; padding: 5px; background-color: #FFFF00;"> <p> <b>WARNING</b></p> <p><b>UNINTENDED EQUIPMENT OPERATION</b></p> <p>If the equipment switches to forced local mode (see page <a href="#">237</a>), the virtual input remains fixed at the last value transmitted.</p> <p>Do not use the virtual input and forced local mode in the same configuration.</p> <p><b>Failure to follow these instructions can result in death or serious injury.</b></p> </div> |  |                  |                 |
| <b>SA3</b>   | <input type="checkbox"/> <b>[Summing ref. 3]</b>   |                  | [No] (nO)       |
|  | <p>Selection of a reference to be added to [Ref.1 channel] (Fr1) or [Ref.1B channel] (Fr1b).</p> <ul style="list-style-type: none"> <li>• Possible assignments are identical to [Summing ref. 2] (SA2) above.</li> </ul>   |                  |                 |
| <b>DA2</b>   | <input type="checkbox"/> <b>[Subtract. ref. 2]</b>   |                  | [No] (nO)       |
|  | <p>Selection of a reference to be subtracted from [Ref.1 channel] (Fr1) or [Ref.1B channel] (Fr1b).</p> <ul style="list-style-type: none"> <li>• Possible assignments are identical to [Summing ref. 2] (SA2) above.</li> </ul>  |                  |                 |
| <b>DA3</b>   | <input type="checkbox"/> <b>[Subtract. ref. 3]</b>   |                  | [No] (nO)       |
|  | <p>Selection of a reference to be subtracted from [Ref.1 channel] (Fr1) or [Ref.1B channel] (Fr1b).</p> <ul style="list-style-type: none"> <li>• Possible assignments are identical to [Summing ref. 2] (SA2) above.</li> </ul>  |                  |                 |
| <b>PA2</b>   | <input type="checkbox"/> <b>[Multiplier ref. 2]</b>  |                  | [No] (nO)       |
|  | <p>Selection of a multiplier reference [Ref.1 channel] (Fr1) or [Ref.1B channel] (Fr1b).</p> <ul style="list-style-type: none"> <li>• Possible assignments are identical to [Summing ref. 2] (SA2) above.</li> </ul>   |                  |                 |
| <b>PA3</b>   | <input type="checkbox"/> <b>[Multiplier ref. 3]</b>  |                  | [No] (nO)       |
|  | <p>Selection of a multiplier reference [Ref.1 channel] (Fr1) or [Ref.1B channel] (Fr1b).</p> <ul style="list-style-type: none"> <li>• Possible assignments are identical to [Summing ref. 2] (SA2) above.</li> </ul>   |                  |                 |

# [1.7 APPLICATION FUNCT.] (FUn-)

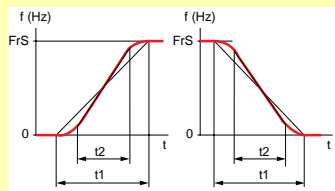
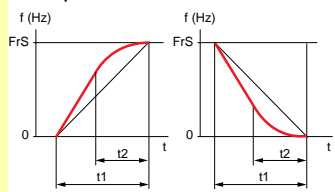
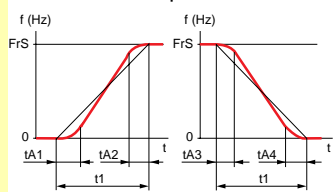
| Code                                      | Name/Description   | Adjustment range | Factory setting            |
|---|--|------------------|----------------------------|
| <b>rPt-</b>                               | <b>[RAMP]</b>  |                  |                            |
| <b>rPt</b><br><br>Lin<br>S<br>U<br>CUS    | <input type="checkbox"/> <b>[Ramp type]</b><br><br><input type="checkbox"/> <b>[Linear] (Lin)</b><br><input type="checkbox"/> <b>[S ramp] (S)</b><br><input type="checkbox"/> <b>[U ramp] (U)</b><br><input type="checkbox"/> <b>[Customized] (CUS)</b><br><br><b>S ramps</b><br><br><br><b>U ramps</b><br><br><br><b>Customized ramps</b><br> |                  | <b>[Linear] (Lin)</b>      |
| <b>Inr</b><br>( )<br><br>0.01<br>0.1<br>1 | <input type="checkbox"/> <b>[Ramp increment]</b><br><br><input type="checkbox"/> <b>[0,01]</b> : Ramp up to 99.99 seconds<br><input type="checkbox"/> <b>[0,1]</b> : Ramp up to 999.9 seconds<br><input type="checkbox"/> <b>[1]</b> : Ramp up to 6000 seconds<br>This parameter is valid for <b>[Acceleration] (ACC)</b> , <b>[Deceleration] (dEC)</b> , <b>[Acceleration 2] (AC2)</b> and <b>[Deceleration 2] (dE2)</b> .  | (1)              | <b>[0,1] (0.1)</b>         |
| <b>ACC</b><br>( )                         | <input type="checkbox"/> <b>[Acceleration]</b><br><br>Time to accelerate from 0 to the <b>[Rated motor freq.] (FrS)</b> (page 67). Make sure that this value is compatible with the inertia being driven.  | (1)              | 0.01 to 6000 s (2)   3.0 s |
| <b>dEC</b><br>( )                         | <input type="checkbox"/> <b>[Deceleration]</b><br><br>Time to decelerate from the <b>[Rated motor freq.] (FrS)</b> (page 67) to 0. Make sure that this value is compatible with the inertia being driven.  | (1)              | 0.01 to 6000 s (2)   3.0 s |

(1) The parameter can also be accessed in the **[1.3 SETTINGS] (SEt-)** menu.

(2) Range 0.01 to 99.99 s or 0.1 to 999.9 s or 1 to 6000 s according to **[Ramp increment] (Inr)**.

**( )** Parameter that can be modified during operation or when stopped.



## [1.7 APPLICATION FUNCT.] (FUn-)

| Code                        | Name/Description   | Adjustment range | Factory setting |
|-----------------------------|--|------------------|-----------------|
| <b>■ [RAMP]</b> (continued) |  |                  |                 |
| <b>EA1</b><br>⌚             | <input type="checkbox"/> <b>[Begin Acc round]</b> (1)<br><ul style="list-style-type: none"> <li>- Rounding of start of acceleration ramp as a % of the <b>[Acceleration] (ACC)</b> or <b>[Acceleration 2] (AC2)</b> ramp time.</li> <li>- Can be set between 0 and 100%</li> <li>- The parameter can be accessed if the <b>[Ramp type] (rPt)</b> is <b>[Customized] (CUS)</b>.</li> </ul>                                | 0 to 100%        | 10%             |
| <b>EA2</b><br>⌚             | <input type="checkbox"/> <b>[End Acc round]</b> (1)<br><ul style="list-style-type: none"> <li>- Rounding of end of acceleration ramp as a % of the <b>[Acceleration] (ACC)</b> or <b>[Acceleration 2] (AC2)</b> ramp time.</li> <li>- Can be set between 0 and (100% - <b>[Begin Acc round] (tA1)</b>)</li> <li>- The parameter can be accessed if the <b>[Ramp type] (rPt)</b> is <b>[Customized] (CUS)</b>.</li> </ul> |                  | 10%             |
| <b>EA3</b><br>⌚             | <input type="checkbox"/> <b>[Begin Dec round]</b> (1)<br><ul style="list-style-type: none"> <li>- Rounding of start of deceleration ramp as a % of the <b>[Deceleration] (dEC)</b> or <b>[Deceleration 2] (dE2)</b> ramp time.</li> <li>- Can be set between 0 and 100%</li> <li>- The parameter can be accessed if the <b>[Ramp type] (rPt)</b> is <b>[Customized] (CUS)</b>.</li> </ul>                                | 0 to 100%        | 10%             |
| <b>EA4</b><br>⌚             | <input type="checkbox"/> <b>[End Dec round]</b> (1)<br><ul style="list-style-type: none"> <li>- Rounding of end of deceleration ramp as a % of the <b>[Deceleration] (dEC)</b> or <b>[Deceleration 2] (dE2)</b> ramp time.</li> <li>- Can be set between 0 and (100% - <b>[Begin Dec round] (tA3)</b>)</li> <li>- The parameter can be accessed if the <b>[Ramp type] (rPt)</b> is <b>[Customized] (CUS)</b>.</li> </ul> |                  | 10%             |

(1) The parameter can also be accessed in the **[1.3 SETTINGS] (SEt-)** menu.

⌚ Parameter that can be modified during operation or when stopped.

## [1.7 APPLICATION FUNCT.] (FUn-)

| Code  | Name/Description  | Adjustment range   | Factory setting |      |   |      |          |   |      |          |   |      |          |   |      |          |   |      |
|---|---|--------------------|-----------------|------|---|------|----------|---|------|----------|---|------|----------|---|------|----------|---|------|
|   | <b>[RAMP]</b> (continued)   |                    |                 |      |   |      |          |   |      |          |   |      |          |   |      |          |   |      |
| <i>Frt</i>  | <input type="checkbox"/> <b>[Ramp 2 threshold]</b><br><br>Ramp switching threshold<br>The 2 <sup>nd</sup> ramp is switched if the value of Frt is not 0 (0 deactivates the function) and the output frequency is greater than Frt.<br>Threshold ramp switching can be combined with <b>[Ramp switch ass.] (rPS)</b> switching as follows: <table border="1" style="margin: 10px auto;"> <thead> <tr> <th>LI or bit</th> <th>Frequency</th> <th>Ramp</th> </tr> </thead> <tbody> <tr> <td>0</td> <td>&lt;Frt</td> <td>ACC, dEC</td> </tr> <tr> <td>0</td> <td>&gt;Frt</td> <td>AC2, dE2</td> </tr> <tr> <td>1</td> <td>&lt;Frt</td> <td>AC2, dE2</td> </tr> <tr> <td>1</td> <td>&gt;Frt</td> <td>AC2, dE2</td> </tr> </tbody> </table>   | LI or bit          | Frequency       | Ramp | 0 | <Frt | ACC, dEC | 0 | >Frt | AC2, dE2 | 1 | <Frt | AC2, dE2 | 1 | >Frt | AC2, dE2 | 0 to 500 or 1600 Hz according to rating | 0 Hz |
| LI or bit   | Frequency   | Ramp               |                 |      |   |      |          |   |      |          |   |      |          |   |      |          |   |      |
| 0   | <Frt  | ACC, dEC           |                 |      |   |      |          |   |      |          |   |      |          |   |      |          |   |      |
| 0   | >Frt  | AC2, dE2           |                 |      |   |      |          |   |      |          |   |      |          |   |      |          |   |      |
| 1   | <Frt  | AC2, dE2           |                 |      |   |      |          |   |      |          |   |      |          |   |      |          |   |      |
| 1   | >Frt  | AC2, dE2           |                 |      |   |      |          |   |      |          |   |      |          |   |      |          |   |      |
| <i>rPS</i><br><br><i>nD</i><br><i>LI1</i><br>-<br>-<br>-  | <input type="checkbox"/> <b>[Ramp switch ass.]</b><br><br><input type="checkbox"/> <b>[No] (nO)</b> : Not assigned<br><input type="checkbox"/> <b>[LI1] (LI1)</b><br>...<br><input type="checkbox"/> <b>[...]</b> (...): See the assignment conditions on page 121.<br>- ACC and dEC are enabled when the assigned input or bit is at 0.<br>- AC2 and dE2 are enabled when the assigned input or bit is at 1.   |                    | [No] (nO)       |      |   |      |          |   |      |          |   |      |          |   |      |          |   |      |
| <i>AC2</i><br> | <input type="checkbox"/> <b>[Acceleration 2]</b> (1)<br><br>Time to accelerate from 0 to the <b>[Rated motor freq.] (FrS)</b> . Make sure that this value is compatible with the inertia being driven.<br>The parameter can be accessed if <b>[Ramp 2 threshold] (Frt)</b> > 0 or if <b>[Ramp switch ass.] (rPS)</b> is assigned.   | 0.01 to 6000 s (2) | 5.0 s           |      |   |      |          |   |      |          |   |      |          |   |      |          |   |      |
| <i>dE2</i><br> | <input type="checkbox"/> <b>[Deceleration 2]</b> (1)<br><br>Time to decelerate from <b>[Rated motor freq.] (FrS)</b> to 0. Make sure that this value is compatible with the inertia being driven.<br>The parameter can be accessed if <b>[Ramp 2 threshold] (Frt)</b> > 0 or if <b>[Ramp switch ass.] (rPS)</b> is assigned.  | 0.01 to 6000 s (2) | 5.0 s           |      |   |      |          |   |      |          |   |      |          |   |      |          |   |      |
| <i>brA</i><br><br><i>nD</i><br><i>YES</i><br><br><i>dYnA</i><br><i>dYnb</i><br><i>dYnC</i>        | <input type="checkbox"/> <b>[Dec ramp adapt.]</b><br><br>Activating this function automatically adapts the deceleration ramp, if this has been set at too low a value for the inertia of the load, which can cause an overvoltage fault.<br><input type="checkbox"/> <b>[No] (nO)</b> : Function inactive<br><input type="checkbox"/> <b>[Yes] (YES)</b> : Function active, for applications that do not require strong deceleration.<br>The following selections appear depending on the rating of the drive and <b>[Motor control type] (Ctt)</b> page 69. They enable stronger deceleration to be obtained than with <b>[Yes] (YES)</b> . Use comparative testing to determine your selection.<br><input type="checkbox"/> <b>[High torq. A] (dYnA)</b><br><input type="checkbox"/> <b>[High torq. B] (dYnb)</b><br><input type="checkbox"/> <b>[High torq. C] (dYnC)</b><br><b>[Dec ramp adapt.] (brA)</b> is forced to <b>[No] (nO)</b> if the brake logic control <b>[Brake assignment] (bLC)</b> is assigned (page 157), or if <b>[Braking balance] (bbA)</b> page 82 = <b>[Yes] (YES)</b> . The factory setting changes to <b>[High torq. A] (dYnA)</b> with certain ratings if <b>[Sinus filter] (OFI)</b> page 79 = <b>[Yes] (YES)</b> .<br>The function is incompatible with applications requiring: <ul style="list-style-type: none"> <li>- Positioning on a ramp</li> <li>- The use of a braking resistor (the resistor would not operate correctly)</li> </ul> |                    | [Yes] (YES)     |      |   |      |          |   |      |          |   |      |          |   |      |          |   |      |

(1) The parameter can also be accessed in the **[1.3 SETTINGS] (SEt-)** menu.

(2) Range 0.01 to 99.99 s or 0.1 to 999.9 s or 1 to 6000 s according to **[Ramp increment] (Inr)** page 134.

 Parameter that can be modified during operation or when stopped.



# [1.7 APPLICATION FUNCT.] (FUn-)

| Code   | Name/Description   | Adjustment range | Factory setting   |
|--|--|------------------|-------------------|
| <b>SEt-</b>  | <div style="background-color: #00FFFF; padding: 5px;"> <h2 style="margin: 0;">[STOP CONFIGURATION]</h2> <p> <b>Note:</b> Some types of stop cannot be used with all other functions. Follow the instructions on page <a href="#">127</a>.</p> </div>   |                  |                   |
| SEt  | <input type="checkbox"/> <b>[Type of stop]</b>   |                  | [Ramp stop] (rMP) |
| rMP<br>FSt<br>nSt<br>dCI                           | <p>Stop mode on disappearance of the run command or appearance of a stop command.</p> <ul style="list-style-type: none"> <li><input type="checkbox"/> <b>[Ramp stop] (rMP):</b> Stop on ramp.</li> <li><input type="checkbox"/> <b>[Fast stop] (FSt):</b> Fast stop</li> <li><input type="checkbox"/> <b>[Freewheel stop] (nSt):</b> Freewheel stop</li> <li><input type="checkbox"/> <b>[DC injection] (dCI):</b> DC injection stop</li> </ul> <p> <b>Note:</b> If the "brake logic" function on page <a href="#">157</a> has been enabled, or if <a href="#">[Low speed time out] (tLS)</a> page <a href="#">60</a> or <a href="#">176</a> is not 0, only ramp type stops may be configured.</p>   |                  |                   |
| FSt<br>  | <input type="checkbox"/> <b>[Freewheel stop Thd.]</b> (1)  | 0.0 to 1600 Hz   | 0.0 Hz            |
|  | <p>This parameter supports switching from a ramp stop or a fast stop to a freewheel stop below a low speed threshold.</p> <p>It can be accessed if <a href="#">[Type of stop] (Stt)</a> = <a href="#">[Fast stop] (FSt)</a> or <a href="#">[Ramp stop] (rMP)</a>.</p> <ul style="list-style-type: none"> <li><input type="checkbox"/> 0.0: Does not switch to freewheel stop.</li> <li><input type="checkbox"/> 0.1 to 1600 Hz: Speed threshold below which the motor will switch to freewheel stop.</li> </ul>  |                  |                   |
| nSt  | <input type="checkbox"/> <b>[Freewheel stop ass.]</b>  |                  | [No] (nO)         |
| nO<br>LI1<br>-<br>-<br>C101<br>-<br>-<br>Cd00<br>- | <ul style="list-style-type: none"> <li><input type="checkbox"/> <b>[No] (nO):</b> Not assigned</li> <li><input type="checkbox"/> <b>[LI1] (LI1) to [LI6] (LI6)</b></li> <li><input type="checkbox"/> <b>[LI7] (LI7) to [LI10] (LI10):</b> If VW3A3201 logic I/O card has been inserted</li> <li><input type="checkbox"/> <b>[LI11] (LI11) to [LI14] (LI14):</b> If VW3A3202 extended I/O card has been inserted</li> <li><input type="checkbox"/> <b>[C101] (C101) to [C115] (C115):</b> With integrated Modbus in [I/O profile] (IO)</li> <li><input type="checkbox"/> <b>[C201] (C201) to [C215] (C215):</b> With integrated CANopen in [I/O profile] (IO)</li> <li><input type="checkbox"/> <b>[C301] (C301) to [C315] (C315):</b> With a communication card in [I/O profile] (IO)</li> <li><input type="checkbox"/> <b>[C401] (C401) to [C415] (C415):</b> With a Controller Inside card in [I/O profile] (IO)</li> <li><input type="checkbox"/> <b>[CD00] (Cd00) to [CD13] (Cd13):</b> In [I/O profile] can be switched with possible logic inputs</li> <li><input type="checkbox"/> <b>[CD14] (Cd14) to [CD15] (Cd15):</b> In [I/O profile] can be switched without logic inputs</li> </ul> <p>The stop is activated when the input or the bit changes to 0. If the input returns to state 1 and the run command is still active, the motor will only restart if <a href="#">[2/3 wire control] (tCC)</a> page <a href="#">86</a> = <a href="#">[2 wire] (2C)</a> and the <a href="#">[2 wire type] (tCt)</a> = <a href="#">[Level] (LEL)</a> or <a href="#">[Fwd priority] (PFO)</a>. If not, a new run command must be sent.</p> |                  |                   |
| FSt  | <input type="checkbox"/> <b>[Fast stop assign.]</b>  |                  | [No] (nO)         |
| nO<br>LI1<br>-<br>-<br>-                           | <p> <b>Note:</b> This function cannot be used with certain other functions. Follow the instructions on page <a href="#">127</a>.</p> <ul style="list-style-type: none"> <li><input type="checkbox"/> <b>[No] (nO):</b> Not assigned</li> <li><input type="checkbox"/> <b>[LI1] (LI1)</b></li> <li style="padding-left: 20px;">⋮</li> <li><input type="checkbox"/> <b>[...] (...):</b> See the assignment conditions on page <a href="#">121</a>.</li> </ul> <p>The stop is activated when the input changes to 0 or the bit changes to 1 (bit in [I/O profile] (IO) at 0). If the input returns to state 1 and the run command is still active, the motor will only restart if <a href="#">[2/3 wire control] (tCC)</a> page <a href="#">86</a> = <a href="#">[2 wire] (2C)</a> and the <a href="#">[2 wire type] (tCt)</a> = <a href="#">[Level] (LEL)</a> or <a href="#">[Fwd priority] (PFO)</a>. If not, a new run command must be sent.</p>   |                  |                   |
| dCF<br>  | <input type="checkbox"/> <b>[Ramp divider]</b> (1)   | 0 to 10          | 4                 |
|  | <p>The parameter can be accessed if <a href="#">[Type of stop] (Stt)</a> = <a href="#">[Fast stop] (FSt)</a> and if <a href="#">[Fast stop assign.] (FSt)</a> is not <a href="#">[No] (nO)</a>.</p> <p>The ramp that is enabled (dEC or dE2) is then divided by this coefficient when stop requests are sent. Value 0 corresponds to a minimum ramp time.</p>  |                  |                   |

(1) The parameter can also be accessed in the [\[1.3 SETTINGS\] \(SEt-\)](#) menu.

Parameter that can be modified during operation or when stopped.

# [1.7 APPLICATION FUNCT.] (FUn-)

| Code   | Name/Description   | Adjustment range                                    | Factory setting         |
|--|--|---|-------------------------|
| <b>■ [STOP CONFIGURATION]</b> (continued)  |  |   |                         |
| <p><b>dCI</b></p> <p>nD</p> <p>L11</p> <p>-</p> <p>-</p> <p>-</p>  | <p><input type="checkbox"/> <b>[DC injection assign.]</b></p> <p> <b>Note:</b> This function cannot be used with certain other functions. Follow the instructions on page 127.</p> <p><input type="checkbox"/> <b>[No] (nO)</b>: Not assigned</p> <p><input type="checkbox"/> <b>[L11] (L11)</b></p> <p style="text-align: center;">⋮</p> <p><input type="checkbox"/> <b>[...] (...)</b>: See the assignment conditions on page 121.</p> <p>DC injection braking is initiated when the assigned input or bit changes to state 1.<br/>If the input returns to state 1 and the run command is still active, the motor will only restart if [2/3 wire control] (tCC) page 86 = [2 wire] (2C) and [2 wire type] (tCt) = [Level] (LEL) or [Fwd priority] (PFO). If not, a new run command must be sent.</p> |   | <p><b>[No] (nO)</b></p> |
| <p><b>IdC</b></p> <p></p>  | <p><input type="checkbox"/> <b>[DC inject. level 1]</b></p> <p>Level of DC injection braking current activated via logic input or selected as stop mode.<br/>The parameter can be accessed if [Type of stop] (Stt) = [DC injection] (dCI) or if [DC injection assign.] (dCI) is not [No] (nO).</p>   | (1) (3)<br>0.1 to 1.41 In (2)                       | 0.64 In (2)             |
| <b>CAUTION</b>   |  |   |                         |
| Check that the motor will withstand this current without overheating.<br><b>Failure to follow this instruction can result in equipment damage.</b> |  |   |                         |
| <p><b>td1</b></p> <p></p>  | <p><input type="checkbox"/> <b>[DC injection time 1]</b></p> <p>Maximum current injection time [DC inject. level 1] (IdC). After this time the injection current becomes [DC inject. level 2] (IdC2).<br/>The parameter can be accessed if [Type of stop] (Stt) = [DC injection] (dCI) or if [DC injection assign.] (dCI) is not [No] (nO).</p>  | (1) (3)<br>0.1 to 30 s                              | 0.5 s                   |
| <p><b>IdC2</b></p> <p></p>   | <p><input type="checkbox"/> <b>[DC inject. level 2]</b></p> <p>Injection current activated by logic input or selected as stop mode, once period of time [DC injection time 1] (td1) has elapsed.<br/>The parameter can be accessed if [Type of stop] (Stt) = [DC injection] (dCI) or if [DC injection assign.] (dCI) is not [No] (nO).</p>   | (1) (3)<br>0.1 In (2) to [DC inject. level 1] (IdC) | 0.5 In (2)              |
| <b>CAUTION</b>   |  |   |                         |
| Check that the motor will withstand this current without overheating.<br><b>Failure to follow this instruction can result in equipment damage.</b> |  |   |                         |
| <p><b>td2</b></p> <p></p>  | <p><input type="checkbox"/> <b>[DC injection time 2]</b></p> <p>Maximum injection time [DC inject. level 2] (IdC2) for injection, selected as stop mode only.<br/>The parameter can be accessed if [Stop type] (Stt) = [DC injection] (dCI).</p>   | (1) (3)<br>0.1 to 30 s                              | 0.5 s                   |





(1) The parameter can also be accessed in the [1.3 SETTINGS] (SEt-) menu.

(2) In corresponds to the rated drive current indicated in the Installation Manual and on the drive nameplate.

(3) Warning: These settings are independent of the [AUTO DC INJECTION] (AdC-) function.

Parameter that can be modified during operation or when stopped.

## [1.7 APPLICATION FUNCT.] (FUn-)

| Code   | Name/Description  | Adjustment range | Factory setting |
|--|---|------------------|-----------------|
| <b>AdC -</b>   | <b>■ [AUTO DC INJECTION]</b>  |                  |                 |
| <b>AdC</b><br>( <br><br>nO<br>YES<br>Ct | <input type="checkbox"/> <b>[Auto DC injection]</b><br>Automatic current injection on stopping (at the end of the ramp)   |                  | [Yes] (YES)     |
|  | <input type="checkbox"/> <b>[No] (nO)</b> : No injection.<br><input type="checkbox"/> <b>[Yes] (YES)</b> : Adjustable injection time.<br><input type="checkbox"/> <b>[Continuous] (Ct)</b> : Continuous standstill injection.<br><b>Warning</b> , there is an interlock between this function and <b>[Motor fluxing] (FLU)</b> page 150. If <b>[Motor fluxing] (FLU) = [Continuous] (FCt) [Auto DC injection] (AdC)</b> must be <b>[No] (nO)</b> .<br> <b>Note</b> : This parameter gives rise to the injection of current even if a run command has not been sent. It can be accessed with the drive running. |                  |                 |
| <b>SdC 1</b><br>(                       | <input type="checkbox"/> <b>[Auto DC inj. level 1]</b> (1)  | 0 to 1.2 In (2)  | 0.7 In (2)      |
|  | Level of standstill DC injection current <b>[Auto DC injection] (AdC)</b> is not <b>[No] (nO)</b> . This parameter is forced to 0 if <b>[Motor control type] (Ctt)</b> page 69 = <b>[Sync. mot.] (SYn)</b> ..<br><br><div style="border: 1px solid black; padding: 5px; text-align: center;"> <b>CAUTION</b><br/>           Check that the motor will withstand this current without overheating.<br/> <b>Failure to follow this instruction can result in equipment damage.</b> </div>   |                  |                 |
| <b>EdC 1</b><br>(                     | <input type="checkbox"/> <b>[Auto DC inj. time 1]</b> (1)   | 0.1 to 30 s      | 0.5 s           |
|  | Standstill injection time. The parameter can be accessed if <b>[Auto DC injection] (AdC)</b> is not <b>[No] (nO)</b> . If <b>[Motor control type] (Ctt)</b> page 69 = <b>[FVC] (FUC)</b> or <b>[Sync. mot.] (SYn)</b> this time corresponds to the zero speed maintenance time.   |                  |                 |
| <b>SdC 2</b><br>(                     | <input type="checkbox"/> <b>[Auto DC inj. level 2]</b> (1)  | 0 to 1.2 In (2)  | 0.5 In (2)      |
|  | 2 <sup>nd</sup> level of standstill DC injection current.<br>The parameter can be accessed if <b>[Auto DC injection] (AdC)</b> is not <b>[No] (nO)</b> .<br>This parameter is forced to 0 if <b>[Motor control type] (Ctt)</b> page 69 = <b>[Sync. mot.] (SYn)</b> ..<br><br><div style="border: 1px solid black; padding: 5px; text-align: center;"> <b>CAUTION</b><br/>           Check that the motor will withstand this current without overheating.<br/> <b>Failure to follow this instruction can result in equipment damage.</b> </div>   |                  |                 |

(1) The parameter can also be accessed in the **[1.3 SETTINGS] (SEt-)** menu.

(2) In corresponds to the rated drive current indicated in the Installation Manual and on the drive nameplate.

 Parameter that can be modified during operation or when stopped.

# [1.7 APPLICATION FUNCT.] (FUn-)

| Code                                   | Name/Description  | Adjustment range | Factory setting |
|--|---|------------------|-----------------|
| <b>[AUTO DC INJECTION]</b> (continued) |   |                  |                 |
| <b>t d C 2</b><br>( )                  | <input type="checkbox"/> <b>[Auto DC inj. time 2]</b> (1)<br><small>2<sup>nd</sup> standstill injection time. The parameter can be accessed if [Auto DC injection] (AdC) = [Yes] (YES.)</small> | 0 to 30 s        | 0 s             |
| AdC                                    | SdC2  | Operation        |                 |
| YES                                    | x   |                  |                 |
| Ct                                     | ≠ 0   |                  |                 |
| Ct                                     | = 0   |                  |                 |
| Run command                            |   |                  |                 |
| Speed                                  |   |                  |                 |

**Note:** When [Motor control type] (Ctt) page 69 = [FVC] (FUC):  
 [Auto DC inj. level 1] (SdC1), [Auto DC inj. level 2] (SdC2) and [Auto DC inj. time 2] (tdC2) cannot be accessed, only [Auto DC inj. time 1] (tdC1) can be accessed. This then corresponds to a zero speed maintenance time.

(1) The parameter can also be accessed in the [1.3 SETTINGS] (SEt-) menu.

( ) Parameter that can be modified during operation or when stopped.

# [1.7 APPLICATION FUNCT.] (FUn-)

| Code           | Name/Description  | Adjustment range | Factory setting |
|----------------|---|------------------|-----------------|
| <b>JOG -</b>   | <div style="background-color: #00b0f0; color: white; padding: 5px;"> <span style="font-size: 24px; color: white;">■</span> <b>[JOG]</b> </div> <p> <b>Note:</b> This function cannot be used with certain other functions. Follow the instructions on page <a href="#">127</a>.</p>   |                  |                 |
| <b>JOG</b>     | <div style="background-color: #ffff00; padding: 5px;"> <span style="font-size: 24px; color: #00b0f0;">□</span> <b>[JOG]</b> <div style="float: right; border: 1px solid #00b0f0; padding: 2px;">[No] (nO)</div> <p>Pulse operation.<br/> <b>The JOG function is only active if the command channel and the reference channels are on the terminals.</b><br/>                     Selecting the assigned logic input or bit activates the function.</p> <ul style="list-style-type: none"> <li><input type="checkbox"/> [No] (nO): Not assigned</li> <li><input type="checkbox"/> [LI1] (LI1) to [LI6] (LI6)</li> <li><input type="checkbox"/> [LI7] (LI7) to [LI10] (LI10): If VW3A3201 logic I/O card has been inserted</li> <li><input type="checkbox"/> [LI11] (LI11) to [LI14] (LI14): If VW3A3202 extended I/O card has been inserted</li> <li><input type="checkbox"/> [C101] (C101) to [C115] (C115): With integrated Modbus in [I/O profile] (IO) profile</li> <li><input type="checkbox"/> [C201] (C201) to [C215] (C215): With integrated CANopen in [I/O profile] (IO) profile</li> <li><input type="checkbox"/> [C301] (C301) to [C315] (C315): With a communication card in [I/O profile] (IO) profile</li> <li><input type="checkbox"/> [C401] (C401) to [C415] (C415): With a Controller Inside card in [I/O profile] (IO) profile</li> <li><input type="checkbox"/> [CD00] (Cd00) to [CD13] (Cd13): In [I/O profile] profile can be switched with possible logic inputs</li> <li><input type="checkbox"/> [CD14] (Cd14) to [CD15] (Cd15): In [I/O profile] profile can be switched without logic inputs</li> </ul> <p>The function is active when the assigned input or bit is at 1.</p> <p>Example: 2-wire control operation (tCC = 2C)</p> </div> |                  |                 |
| <b>JGF</b><br> | <div style="background-color: #ffff00; padding: 5px;"> <span style="font-size: 24px; color: #00b0f0;">□</span> <b>[Jog frequency]</b> <div style="float: right; border: 1px solid #00b0f0; padding: 2px;">(1)</div> <p>The parameter can be accessed if [JOG] (JOG) is not [No] (nO).<br/>Reference in jog operation</p> </div>   | 0 to 10 Hz       | 10 Hz           |
| <b>JGt</b><br> | <div style="background-color: #ffff00; padding: 5px;"> <span style="font-size: 24px; color: #00b0f0;">□</span> <b>[Jog delay]</b> <div style="float: right; border: 1px solid #00b0f0; padding: 2px;">(1)</div> <p>The parameter can be accessed if [JOG] (JOG) is not [No] (nO).<br/>Anti-repeat delay between 2 consecutive jog operations.</p> </div>  | 0 to 2.0 s       | 0.5 s           |

(1) The parameter can also be accessed in the [\[1.3 SETTINGS\] \(SEt-\)](#) menu.

Parameter that can be modified during operation or when stopped.

## [1.7 APPLICATION FUNCT.] (FUn-)

### Preset speeds

2, 4, 8 or 16 speeds can be preset, requiring 1, 2, 3 or 4 logic inputs respectively.

 **Note:** You must configure 2 and 4 speeds in order to obtain 4 speeds.  
You must configure 2, 4 and 8 speeds in order to obtain 8 speeds.  
You must configure 2, 4, 8, and 16 speeds in order to obtain 16 speeds.

Combination table for preset speed inputs

| 16 speeds<br>LI (PS16) | 8 speeds<br>LI (PS8) | 4 speeds<br>LI (PS4) | 2 speeds<br>LI (PS2) | Speed reference |
|------------------------|----------------------|----------------------|----------------------|-----------------|
| 0                      | 0                    | 0                    | 0                    | Reference (1)   |
| 0                      | 0                    | 0                    | 1                    | SP2             |
| 0                      | 0                    | 1                    | 0                    | SP3             |
| 0                      | 0                    | 1                    | 1                    | SP4             |
| 0                      | 1                    | 0                    | 0                    | SP5             |
| 0                      | 1                    | 0                    | 1                    | SP6             |
| 0                      | 1                    | 1                    | 0                    | SP7             |
| 0                      | 1                    | 1                    | 1                    | SP8             |
| 1                      | 0                    | 0                    | 0                    | SP9             |
| 1                      | 0                    | 0                    | 1                    | SP10            |
| 1                      | 0                    | 1                    | 0                    | SP11            |
| 1                      | 0                    | 1                    | 1                    | SP12            |
| 1                      | 1                    | 0                    | 0                    | SP13            |
| 1                      | 1                    | 0                    | 1                    | SP14            |
| 1                      | 1                    | 1                    | 0                    | SP15            |
| 1                      | 1                    | 1                    | 1                    | SP16            |

(1) See the diagram on page [115](#): Reference 1 = (SP1).

## [1.7 APPLICATION FUNCT.] (FUn-)

| Code  | Name/Description   | Adjustment range | Factory setting |
|---|--|------------------|-----------------|
| <b>P55-</b>   | <p><b>■ [PRESET SPEEDS]</b></p> <p> <b>Note:</b> This function cannot be used with certain other functions. Follow the instructions on page <a href="#">127</a>.</p>  |                  |                 |
| <b>P52</b><br><i>nD</i><br><b>L I I</b><br>-<br>-<br>-  | <p><input type="checkbox"/> <b>[2 preset speeds]</b></p> <p><input type="checkbox"/> <b>[No] (nO)</b>: Function inactive</p> <p><input type="checkbox"/> <b>[LI1] (LI1)</b></p> <p>⋮</p> <p><input type="checkbox"/> <b>[...] (...)</b>: See the assignment conditions on page <a href="#">121</a>.</p>  |                  | [No] (nO)       |
| <b>P54</b><br><i>nD</i><br><b>L I I</b><br>-<br>-<br>-  | <p><input type="checkbox"/> <b>[4 preset speeds]</b></p> <p><input type="checkbox"/> <b>[No] (nO)</b>: Function inactive</p> <p><input type="checkbox"/> <b>[LI1] (LI1)</b></p> <p>⋮</p> <p><input type="checkbox"/> <b>[...] (...)</b>: See the assignment conditions on page <a href="#">121</a>.</p> <p>To obtain 4 speeds you must also configure 2 speeds.</p>            |                  | [No] (nO)       |
| <b>P58</b><br><i>nD</i><br><b>L I I</b><br>-<br>-<br>-  | <p><input type="checkbox"/> <b>[8 preset speeds]</b></p> <p><input type="checkbox"/> <b>[No] (nO)</b>: Function inactive</p> <p><input type="checkbox"/> <b>[LI1] (LI1)</b></p> <p>⋮</p> <p><input type="checkbox"/> <b>[...] (...)</b>: See the assignment conditions on page <a href="#">121</a>.</p> <p>To obtain 8 speeds you must also configure 2 and 4 speeds.</p>      |                  | [No] (nO)       |
| <b>P516</b><br><i>nD</i><br><b>L I I</b><br>-<br>-<br>- | <p><input type="checkbox"/> <b>[16 preset speeds]</b></p> <p><input type="checkbox"/> <b>[No] (nO)</b>: Function inactive</p> <p><input type="checkbox"/> <b>[LI1] (LI1)</b></p> <p>⋮</p> <p><input type="checkbox"/> <b>[...] (...)</b>: See the assignment conditions on page <a href="#">121</a>.</p> <p>To obtain 16 speeds you must also configure 2, 4 and 8 speeds.</p> |                  | [No] (nO)       |

## [1.7 APPLICATION FUNCT.] (FUn-)

| Code  | Name/Description                               | Adjustment range | Factory setting |
|---|--|------------------|-----------------|
| <b>■ [PRESET SPEEDS]</b> (continued)  |  |                  |                 |
| <b>SP 2</b><br>( )  | <input type="checkbox"/> [Preset speed 2] (1)  | 0 to 1600 Hz     | 10 Hz           |
| <b>SP 3</b><br>( )  | <input type="checkbox"/> [Preset speed 3] (1)  |                  | 15 Hz           |
| <b>SP 4</b><br>( )  | <input type="checkbox"/> [Preset speed 4] (1)  |                  | 20 Hz           |
| <b>SP 5</b><br>( )  | <input type="checkbox"/> [Preset speed 5] (1)  |                  | 25 Hz           |
| <b>SP 6</b><br>( )  | <input type="checkbox"/> [Preset speed 6] (1)  |                  | 30 Hz           |
| <b>SP 7</b><br>( )  | <input type="checkbox"/> [Preset speed 7] (1)  |                  | 35 Hz           |
| <b>SP 8</b><br>( )  | <input type="checkbox"/> [Preset speed 8] (1)  |                  | 40 Hz           |
| <b>SP 9</b><br>( )  | <input type="checkbox"/> [Preset speed 9] (1)  |                  | 45 Hz           |
| <b>SP 10</b><br>( )   | <input type="checkbox"/> [Preset speed 10] (1) |                  | 50 Hz           |
| <b>SP 11</b><br>( )   | <input type="checkbox"/> [Preset speed 11] (1) |                  | 55 Hz           |
| <b>SP 12</b><br>( )   | <input type="checkbox"/> [Preset speed 12] (1) |                  | 60 Hz           |
| <b>SP 13</b><br>( )   | <input type="checkbox"/> [Preset speed 13] (1) |                  | 70 Hz           |
| <b>SP 14</b><br>( )   | <input type="checkbox"/> [Preset speed 14] (1) |                  | 80 Hz           |
| <b>SP 15</b><br>( )   | <input type="checkbox"/> [Preset speed 15] (1) |                  | 90 Hz           |
| <b>SP 16</b><br>( )   | <input type="checkbox"/> [Preset speed 16] (1) |                  | 100 Hz          |
| The appearance of these [Preset speed x] (SPx) parameters is determined by the number of speeds configured. |  |                  |                 |

(1) The parameter can also be accessed in the [1.3 SETTINGS] (SEt-) menu.

 Parameter that can be modified during operation or when stopped.



## [1.7 APPLICATION FUNCT.] (FUn-)

### +/- speed

Two types of operation are available.

- Use of single action buttons:** Two logic inputs are required in addition to the operating direction(s).  
The input assigned to the "+ speed" command increases the speed, the input assigned to the "- speed" command decreases the speed.
- Use of double action buttons:** Only one logic input assigned to "+ speed" is required.

+/- speed with double-press buttons:

Description: 1 button pressed twice (2 steps) for each direction of rotation. A contact closes each time the button is pressed.

|                | Released (- speed) | 1 <sup>st</sup> press<br>(speed maintained) | 2 <sup>nd</sup> press<br>(faster) |
|----------------|--------------------|---|-----------------------------------|
| Forward button | –                  | a   | a and b                           |
| Reverse button | –                  | c   | c and d                           |

Example of wiring:

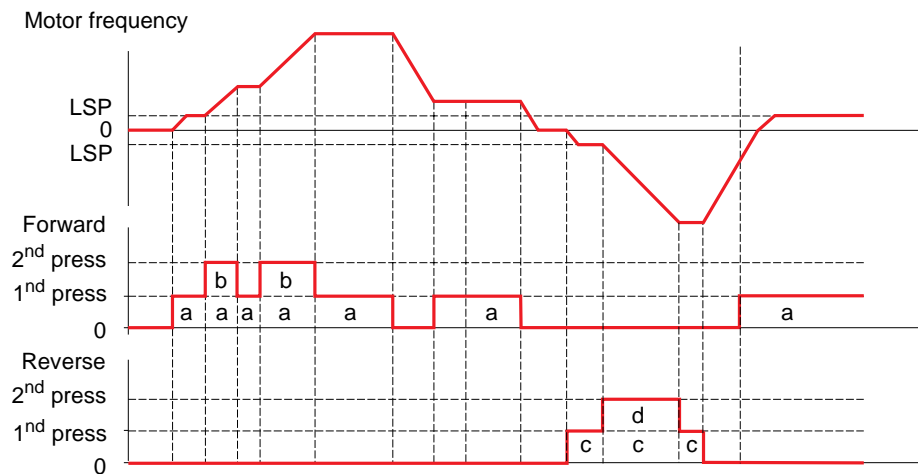
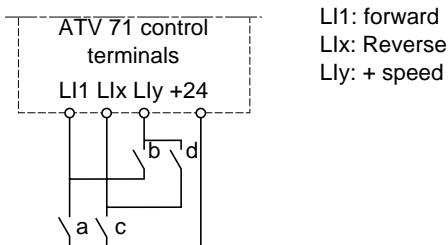

Do not use this +/-speed type with 3-wire control.

Whichever type of operation is selected, the max. speed is set by **[High speed] (HSP)** (see page 42).

#### Note:

If the reference is switched via rFC (see page 123) from any one reference channel to another reference channel with "+/- speed", the value of reference rFr (after ramp) may be copied at the same time in accordance with the **[Copy channel 1 --> 2] (COP)** parameter, see page 124. If the reference is switched via rFC (see page 123) from one reference channel to any other reference channel with "+/- speed", the value of reference rFr (after ramp) is always copied at the same time.

This prevents the speed being incorrectly reset to zero when switching takes place.

# [1.7 APPLICATION FUNCT.] (FUn-)

| Code         | Name/Description  | Adjustment range | Factory setting  |
|--------------|---|------------------|------------------|
| <b>UPd -</b> | <p><b>■ [+/- SPEED]</b></p> <p>Function can be accessed if reference channel [Ref.2 channel] (Fr2) = [+/-Speed] (UPdt) see page 123.<br/>  <b>Note:</b> This function cannot be used with certain other functions. Follow the instructions on page 127.</p>  |                  |                  |
| <b>USP</b>   | <p><input type="checkbox"/> <b>[+ speed assignment]</b></p> <p><input type="checkbox"/> <b>[No]</b> (nO): Function inactive</p> <p><input type="checkbox"/> <b>[LI1]</b> (LI1) to <b>[LI6]</b> (LI6)</p> <p><input type="checkbox"/> <b>[LI7]</b> (LI7) to <b>[LI10]</b> (LI10): If VW3A3201 logic I/O card has been inserted</p> <p><input type="checkbox"/> <b>[LI11]</b> (LI11) to <b>[LI14]</b> (LI14): If VW3A3202 extended I/O card has been inserted</p> <p><input type="checkbox"/> <b>[C101]</b> (C101) to <b>[C115]</b> (C115): With integrated Modbus in [I/O profile] (IO)</p> <p><input type="checkbox"/> <b>[C201]</b> (C201) to <b>[C215]</b> (C215): With integrated CANopen in [I/O profile] (IO)</p> <p><input type="checkbox"/> <b>[C301]</b> (C301) to <b>[C315]</b> (C315): With a communication card in [I/O profile] (IO)</p> <p><input type="checkbox"/> <b>[C401]</b> (C401) to <b>[C415]</b> (C415): With a Controller Inside card in [I/O profile] (IO)</p> <p><input type="checkbox"/> <b>[CD00]</b> (Cd00) to <b>[CD13]</b> (Cd13): In [I/O profile] can be switched with possible logic inputs</p> <p><input type="checkbox"/> <b>[CD14]</b> (Cd14) to <b>[CD15]</b> (Cd15): In [I/O profile] can be switched without logic inputs</p> <p>Function active if the assigned input or bit is at 1.</p> |                  | <b>[No]</b> (nO) |
| <b>dSP</b>   | <p><input type="checkbox"/> <b>[-Speed assignment]</b></p> <p><input type="checkbox"/> <b>[No]</b> (nO): Function inactive</p> <p><input type="checkbox"/> <b>[LI1]</b> (LI1) to <b>[LI6]</b> (LI6)</p> <p><input type="checkbox"/> <b>[LI7]</b> (LI7) to <b>[LI10]</b> (LI10): If VW3A3201 logic I/O card has been inserted</p> <p><input type="checkbox"/> <b>[LI11]</b> (LI11) to <b>[LI14]</b> (LI14): If VW3A3202 extended I/O card has been inserted</p> <p><input type="checkbox"/> <b>[C101]</b> (C101) to <b>[C115]</b> (C115): With integrated Modbus in [I/O profile] (IO)</p> <p><input type="checkbox"/> <b>[C201]</b> (C201) to <b>[C215]</b> (C215): With integrated CANopen in [I/O profile] (IO)</p> <p><input type="checkbox"/> <b>[C301]</b> (C301) to <b>[C315]</b> (C315): With a communication card in [I/O profile] (IO)</p> <p><input type="checkbox"/> <b>[C401]</b> (C401) to <b>[C415]</b> (C415): With a Controller Inside card in [I/O profile] (IO)</p> <p><input type="checkbox"/> <b>[CD00]</b> (Cd00) to <b>[CD13]</b> (Cd13): In [I/O profile] can be switched with possible logic inputs</p> <p><input type="checkbox"/> <b>[CD14]</b> (Cd14) to <b>[CD15]</b> (Cd15): In [I/O profile] can be switched without logic inputs</p> <p>Function active if the assigned input or bit is at 1.</p>  |                  | <b>[No]</b> (nO) |
| <b>SEr</b>   | <p><input type="checkbox"/> <b>[Reference saved]</b></p> <p>Associated with the "+/- speed" function, this parameter can be used to save the reference:</p> <ul style="list-style-type: none"> <li>• When the run commands disappear (saved to RAM)</li> <li>• When the line supply or the run commands disappear (saved to EEPROM)</li> </ul> <p>Therefore, the next time the drive starts up, the speed reference is the last reference saved.</p> <p><input type="checkbox"/> <b>[No]</b> (nO): No save (the next time the drive starts up, the speed reference is <b>[Low speed]</b> (LSP), see page 42)</p> <p><input type="checkbox"/> <b>[RAM]</b> (rAM): Saved in RAM</p> <p><input type="checkbox"/> <b>[EEprom]</b> (EEP): Saved in EEPROM</p>  |                  | <b>[No]</b> (nO) |



## +/- speed around a reference

The reference is given by Fr1 or Fr1b with summing/subtraction/multiplication functions and preset speeds if relevant (see the diagram on page 115). For improved clarity, we will call this reference A. The action of the +speed and -speed buttons can be set as a % of this reference A. On stopping, the reference (A +/- speed) is not saved, so the drive restarts with reference A+ only. The maximum total reference is always limited by [High speed] (HSP) and the minimum reference by [Low speed] (LSP), see page 42.

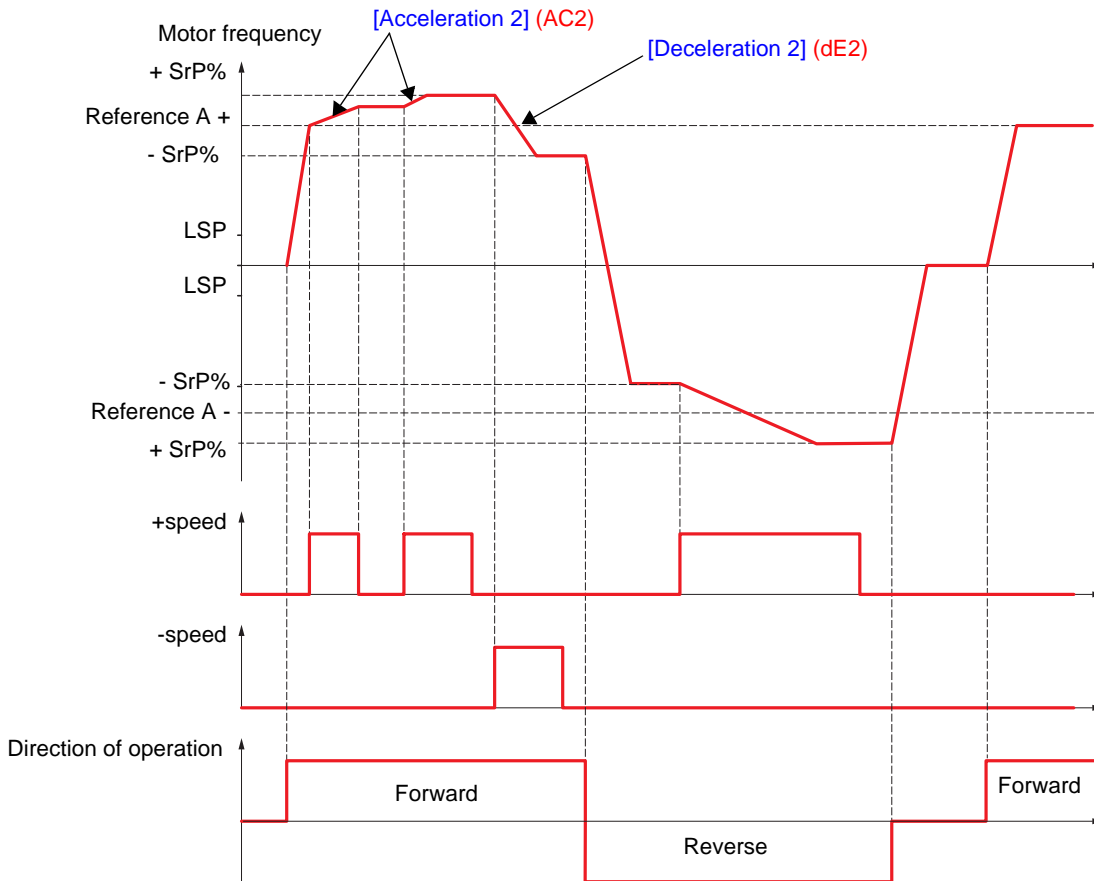
Example of 2-wire control:



## [1.7 APPLICATION FUNCT.] (FUn-)

| Code   | Name/Description   | Adjustment range   | Factory setting |
|--|--|--------------------|-----------------|
| <b>SrE-</b>  | <p><b>■ [+/-SPEED AROUND REF.]</b></p> <p>The function can be accessed for reference channel [Ref.1 channel] (Fr1).</p> <p> <b>Note:</b> This function cannot be used with certain other functions. Follow the instructions on page 127.</p>      |                    |                 |
| US1<br>n0<br>L11<br>-<br>-<br>-  | <p><input type="checkbox"/> <b>[+ speed assignment]</b></p> <p><input type="checkbox"/> [No] (n0): Function inactive</p> <p><input type="checkbox"/> [LI1] (LI1)</p> <p>⋮</p> <p><input type="checkbox"/> [...] (...): See the assignment conditions on page 121.</p> <p>Function active if the assigned input or bit is at 1.</p> |                    | [No] (n0)       |
| dS1<br>n0<br>L11<br>-<br>-<br>-  | <p><input type="checkbox"/> <b>[-Speed assignment]</b></p> <p><input type="checkbox"/> [No] (n0): Function inactive</p> <p><input type="checkbox"/> [LI1] (LI1)</p> <p>⋮</p> <p><input type="checkbox"/> [...] (...): See the assignment conditions on page 121.</p> <p>Function active if the assigned input or bit is at 1.</p>  |                    | [No] (n0)       |
| SrP<br> | <p><input type="checkbox"/> <b>[+/-Speed limitation]</b></p> <p>This parameter limits the variation range with +/- speed as a % of the reference. The ramps used in this function are [Acceleration 2] (AC2) and [Deceleration 2] (dE2).<br/>The parameter can be accessed if +/- speed is assigned.</p>                           | 0 to 50 %          | 10 %            |
| AC2  | <p><input type="checkbox"/> <b>[Acceleration 2]</b> (1)</p> <p>Time to accelerate from 0 to the [Rated motor freq.] (FrS). Make sure that this value is compatible with the inertia being driven.<br/>The parameter can be accessed if +/- speed is assigned.</p>  | 0.01 to 6000 s (2) | 5.0 s           |
| dE2  | <p><input type="checkbox"/> <b>[Deceleration 2]</b> (1)</p> <p>Time to decelerate from the [Rated motor freq.] (FrS) to 0. Make sure that this value is compatible with the inertia being driven.<br/>The parameter can be accessed if +/- speed is assigned.</p>  | 0.01 to 6000 s (2) | 5.0 s           |

(1) The parameter can also be accessed in the [1.3 SETTINGS] (SEt-) menu.

(2) Range 0.01 to 99.99 s or 0.1 to 999.9 s or 1 to 6000 s according to [Ramp increment] (Inr) page 134.



Parameter that can be modified during operation or when stopped.

# [1.7 APPLICATION FUNCT.] (FUn-)

## Save reference

Saving a speed reference value using a logic input command lasting longer than 0.1 s.

- This function is used to control the speed of several drives alternately via a single analog reference and one logic input for each drive.
- It is also used to confirm a line reference (communication bus or network) on several drives via a logic input. This allows movements to be synchronized by getting rid of variations when the reference is set.
- The reference is acquired 100 ms after the rising edge of the request. A new reference is not then acquired until a new request is made.

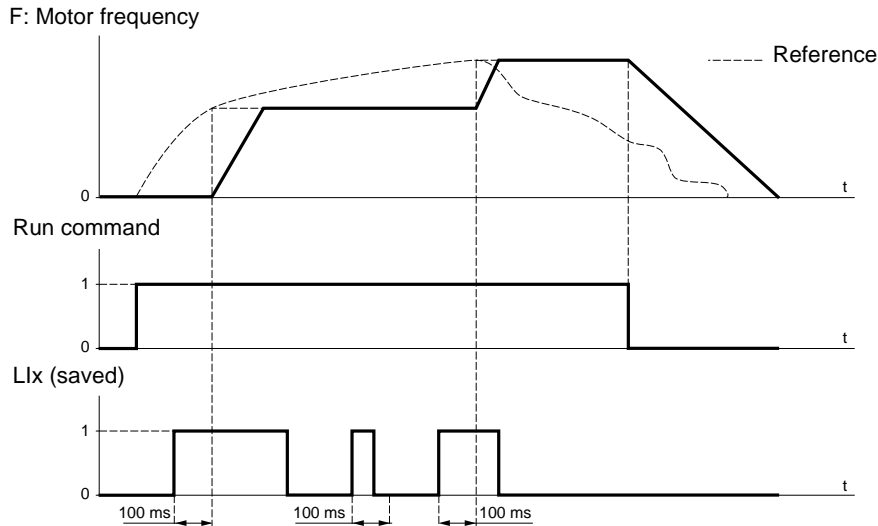

| Code        | Name/Description  | Adjustment range | Factory setting |
|-------------|---|------------------|-----------------|
| <b>SPn-</b> | <b>[MEMO REFERENCE]</b>   |                  |                 |
| <b>SPn</b>  | <input type="checkbox"/> <b>[Ref. memo ass.]</b>  |                  | [No] (nO)       |
| nO          | <input type="checkbox"/> <b>[No] (nO):</b> Function inactive  |                  |                 |
| L11         | <input type="checkbox"/> <b>[LI1] (LI1) to [LI6] (LI6)</b>  |                  |                 |
| -           | <input type="checkbox"/> <b>[LI7] (LI7) to [LI10] (LI10):</b> If VW3A3201 logic I/O card has been inserted      |                  |                 |
| L114        | <input type="checkbox"/> <b>[LI11] (LI11) to [LI14] (LI14):</b> If VW3A3202 extended I/O card has been inserted |                  |                 |
|             | Assignment to a logic input   |                  |                 |
|             | Function active if the assigned input is at 1.  |                  |                 |

## [1.7 APPLICATION FUNCT.] (FUn-)

| Code  | Name/Description   | Adjustment range | Factory setting |
|---|--|------------------|-----------------|
| <b>FL I-</b>  | <b>■ [FLUXING BY LI]</b>   |                  |                 |
| <b>FLU</b><br>( )                                       | <input type="checkbox"/> <b>[Motor fluxing]</b>  | (1)              | [No] (FnO)      |
| <b>FnC</b><br><b>FcE</b><br><b>FnD</b>                  | <input type="checkbox"/> <b>[Not cont.] (FnC)</b> : Non-continuous mode<br><input type="checkbox"/> <b>[Continuous] (FcT)</b> : Continuous mode. This option is not possible if <b>[Auto DC injection] (AdC)</b> page 139 is <b>[Yes] (YES)</b> or if <b>[Type of stop] (Stt)</b> page 137 is <b>[Freewheel] (nSt)</b> .<br><input type="checkbox"/> <b>[No] (FnO)</b> : Function inactive This option is not possible if <b>[Motor control type] (Ctt)</b> page 69 = <b>[SVCI] (CUC)</b> or <b>[FVC] (FUC)</b> .<br>If <b>[Motor control type] (Ctt)</b> page 69 = <b>[SVCI] (CUC)</b> , <b>[FVC] (FUC)</b> or <b>[Sync. mot.] (SYn)</b> or <b>[SVC V] (UUC)</b> at and above 55 kW (75 HP) for ATV71●●●●M3X and at and above 90 kW (120 HP) for ATV71●●●●N4, the factory setting is replaced by <b>[Not cont.] (FnC)</b> .<br><br>In order to obtain rapid high torque on startup, magnetic flux needs to already have been established in the motor. <ul style="list-style-type: none"> <li>• In <b>[Continuous] (FcT)</b> mode, the drive automatically builds up flux when it is powered up.</li> <li>• In <b>[Not cont.] (FnC)</b> mode, fluxing occurs when the motor starts up.</li> </ul> The flux current is greater than nCr (configured rated motor current) when the flux is established and is then adjusted to the motor magnetizing current... |                  |                 |
|   | <b>CAUTION</b><br><br>Check that the motor will withstand this current without overheating.<br><b>Failure to follow this instruction can result in equipment damage.</b>   |                  |                 |
|   | If <b>[Motor control type] (Ctt)</b> page 69 = <b>[Sync. mot.] (SYn)</b> , the <b>[Motor fluxing] (FLU)</b> parameter causes the alignment of the rotor and not the fluxing.<br>If <b>[Brake assignment] (bLC)</b> page 157 is not <b>[No] (nO)</b> , the <b>[Motor fluxing] (FLU)</b> parameter has no effect.  |                  |                 |
| <b>FL I</b><br><b>nD</b><br><b>L I I</b><br>-<br>-<br>- | <input type="checkbox"/> <b>[Fluxing assignment]</b>   |                  | [No] (nO)       |
|   | <input type="checkbox"/> <b>[No] (nO)</b> : Function inactive<br><br><input type="checkbox"/> <b>[LI1] (LI1)</b><br>:<br>:<br><input type="checkbox"/> <b>[...] (...)</b> : See the assignment conditions on page 121.<br><br>Assignment is only possible if <b>[Motor fluxing] (FLU)</b> is not <b>[Continuous] (FcT)</b> . <ul style="list-style-type: none"> <li>• In <b>[Not cont.] (FnC)</b> mode:                             <ul style="list-style-type: none"> <li>- If an LI or a bit is assigned to the motor fluxing command, flux is built up when the assigned input or bit is at 1.</li> <li>- If an LI or a bit has not been assigned, or if the LI or bit assigned is at 0 when a run command is sent, fluxing occurs when the motor starts.</li> </ul> </li> <li>• In <b>[No] (FnO)</b> mode:                             <ul style="list-style-type: none"> <li>- If an LI or a bit is assigned to the motor fluxing command, flux is built up when the assigned input or bit is at 1 and is suppressed when the assigned input or bit is at 0.</li> </ul> </li> </ul>   |                  |                 |

(1) The parameter can also be accessed in the **[1.3 SETTINGS] (SEt-)** menu.

 Parameter that can be modified during operation or when stopped.

### Limit switch management

This function can be used to manage trajectory limits using limit switches.

The stop mode is configurable.

When the stop contact is activated, startup in the other direction is authorized.

Example:

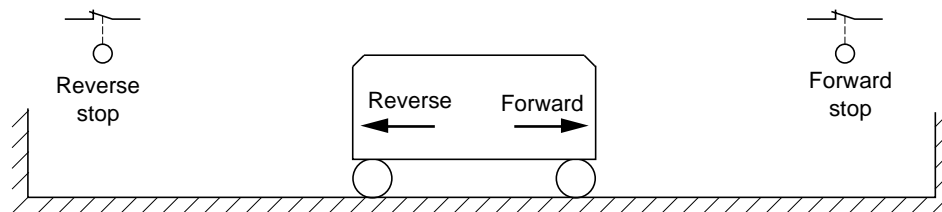

The stop is activated when the input is at 0 (contact open).

# [1.7 APPLICATION FUNCT.] (FUn-

Handling

Lifts

Hoisting

| Code  | Name/Description   | Adjustment range | Factory setting   |
|---|--|------------------|-------------------|
| <b>LSE -</b>  | <div style="background-color: #00FFFF; padding: 5px;"> <p><b>■ [LIMIT SWITCHES]</b></p> <p> <b>Note:</b> This function cannot be used with certain other functions. Follow the instructions on page <a href="#">127</a>.</p> </div>  |                  |                   |
| <b>LAF</b><br><i>nD</i><br><b>LI1</b><br>-<br>-<br><b>CI01</b><br>-<br>-<br>-<br><b>CD00</b><br>- | <input type="checkbox"/> <b>[Stop FW limit sw.]</b><br><br><input type="checkbox"/> <b>[No] (nO)</b> : Function inactive<br><input type="checkbox"/> <b>[LI1] (LI1) to [LI6] (LI6)</b><br><input type="checkbox"/> <b>[LI7] (LI7) to [LI10] (LI10)</b> : If VW3A3201 logic I/O card has been inserted<br><input type="checkbox"/> <b>[LI11] (LI11) to [LI14] (LI14)</b> : If VW3A3202 extended I/O card has been inserted<br><input type="checkbox"/> <b>[C101] (C101) to [C115] (C115)</b> : With integrated Modbus in [I/O profile] (IO)<br><input type="checkbox"/> <b>[C201] (C201) to [C215] (C215)</b> : With integrated CANopen in [I/O profile] (IO)<br><input type="checkbox"/> <b>[C301] (C301) to [C315] (C315)</b> : With a communication card in [I/O profile] (IO)<br><input type="checkbox"/> <b>[C401] (C401) to [C415] (C415)</b> : With a Controller Inside card in [I/O profile] (IO)<br><input type="checkbox"/> <b>[CD00] (Cd00) to [CD13] (Cd13)</b> : In [I/O profile] (IO) can be switched with possible logic inputs<br><input type="checkbox"/> <b>[CD14] (Cd14) to [CD15] (Cd15)</b> : In [I/O profile] (IO) can be switched without logic inputs |                  | [No] (nO)         |
| <b>LAr</b>  | <input type="checkbox"/> <b>[Stop RV limit sw.]</b><br><br>Same assignments possible as for <a href="#">[Stop FW limit sw.] (LAF)</a> below.   |                  | [No] (nO)         |
| <b>LAS</b><br><i>rNP</i><br><b>FSt</b><br><i>nSt</i>  | <input type="checkbox"/> <b>[Stop type]</b><br><br><input type="checkbox"/> <b>[Ramp stop] (rMP)</b><br><input type="checkbox"/> <b>[Fast stop] (FSt)</b><br><input type="checkbox"/> <b>[Freewheel] (nSt)</b><br><br>When the assigned input changes to 0, the stop is controlled in accordance with the selected type. Restarting is only authorized for the other operating direction once the motor has stopped. If the two inputs <a href="#">[Stop FW limit sw.] (LAF)</a> and <a href="#">[Stop RV limit sw.] (LAr)</a> are assigned and at state 0, restarting will be impossible.<br>The parameter can be accessed if <a href="#">[Stop FW limit sw.] (LAF)</a> or <a href="#">[Stop RV limit sw.] (LAr)</a> is assigned.   |                  | [Freewheel] (nSt) |



### Brake logic control

Used to control an electromagnetic brake by the drive, for horizontal and vertical hoisting applications, and for unbalanced machines.

#### Principle:

##### Vertical hoisting movement:

Maintain motor torque in the driving load holding direction during brake opening and closing, in order to hold the load, start smoothly when the brake is released and stop smoothly when the brake is engaged.

##### Horizontal movement:

Synchronize brake release with the build-up of torque during startup and brake engage at zero speed on stopping, to prevent jolting.

#### Recommended settings for brake logic control for a vertical hoisting application:

|  |
|--|
|  <b>WARNING</b>                                 |
| <b>UNINTENDED EQUIPMENT OPERATION</b>  |
| Check that the selected settings and configurations will not result in the dropping or loss of control of the load being lifted. |
| <b>Failure to follow these instructions can result in death or serious injury.</b>   |

1. Brake impulse (bIP): YES. Ensure that the direction of rotation FW corresponds to lifting the load.  
For applications in which the load being lowered is very different from the load being lifted, set BIP = 2 lbr (e.g., ascent always with a load and descent always without a load).
2. Brake release current (lbr and lrd if BIP = 2 lbr): Adjust the brake release current to the rated current indicated on the motor.  
During testing, adjust the brake release current in order to hold the load smoothly.
3. Acceleration time: For hoisting applications it is advisable to set the acceleration ramps to more than 0.5 seconds. Ensure that the drive does not exceed the current limit.  
The same recommendation applies for deceleration.  
Reminder: For a hoisting movement, a braking resistor should be used.
4. Brake release time (brt): Set according to the type of brake. It is the time required for the mechanical brake to release.
5. Brake release frequency (blr), in open-loop mode only: Leave in [Auto], adjust if necessary.
6. Brake engage frequency (bEn): Leave in [Auto], adjust if necessary.
7. Brake engage time (bEt): Set according to the type of brake. It is the time required for the mechanical brake to engage.

#### Recommended settings for brake logic control for a horizontal hoisting application:

1. Brake impulse (bIP): No
2. Brake release current (lbr): Set to 0.
3. Brake release time (brt): Set according to the type of brake. It is the time required for the mechanical brake to release.
4. Brake engage frequency (bEn), in open-loop mode only: Leave in [Auto], adjust if necessary.
5. Brake engage time (bEt): Set according to the type of brake. It is the time required for the mechanical brake to engage.

Brake logic control, horizontal movement in open-loop mode

Handling

Lifts

Hoisting

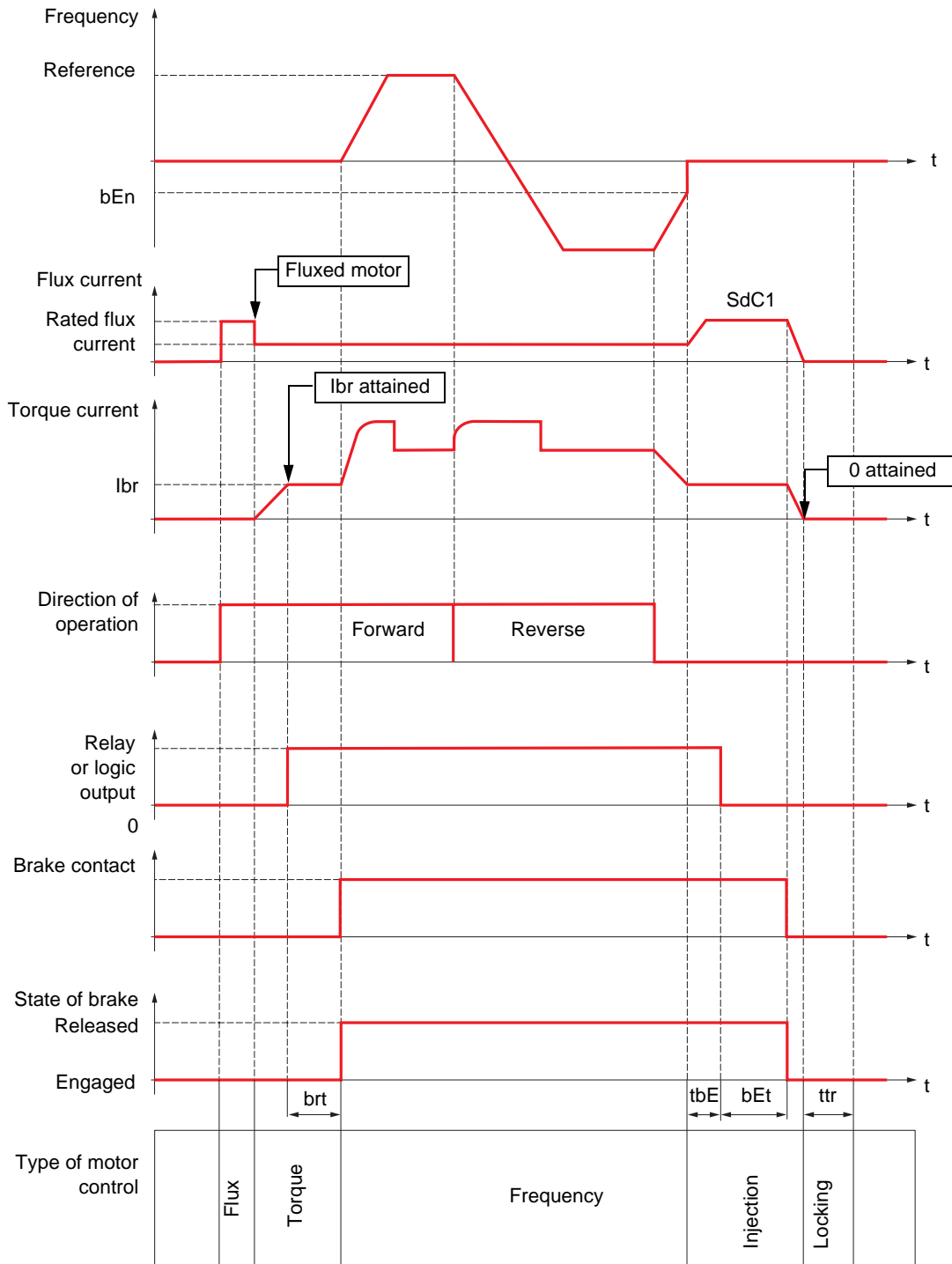

- Key:
- (bEn): [Brake engage freq]
  - (bEt): [Brake engage time]
  - (brt): [Brake Release time]
  - (lbr): [Brake release I FW]
  - (SdC1): [Auto DC inj. level 1]
  - (tbE): [Brake engage delay]
  - (ttr): [Time to restart]

Brake logic control, vertical movement in open-loop mode

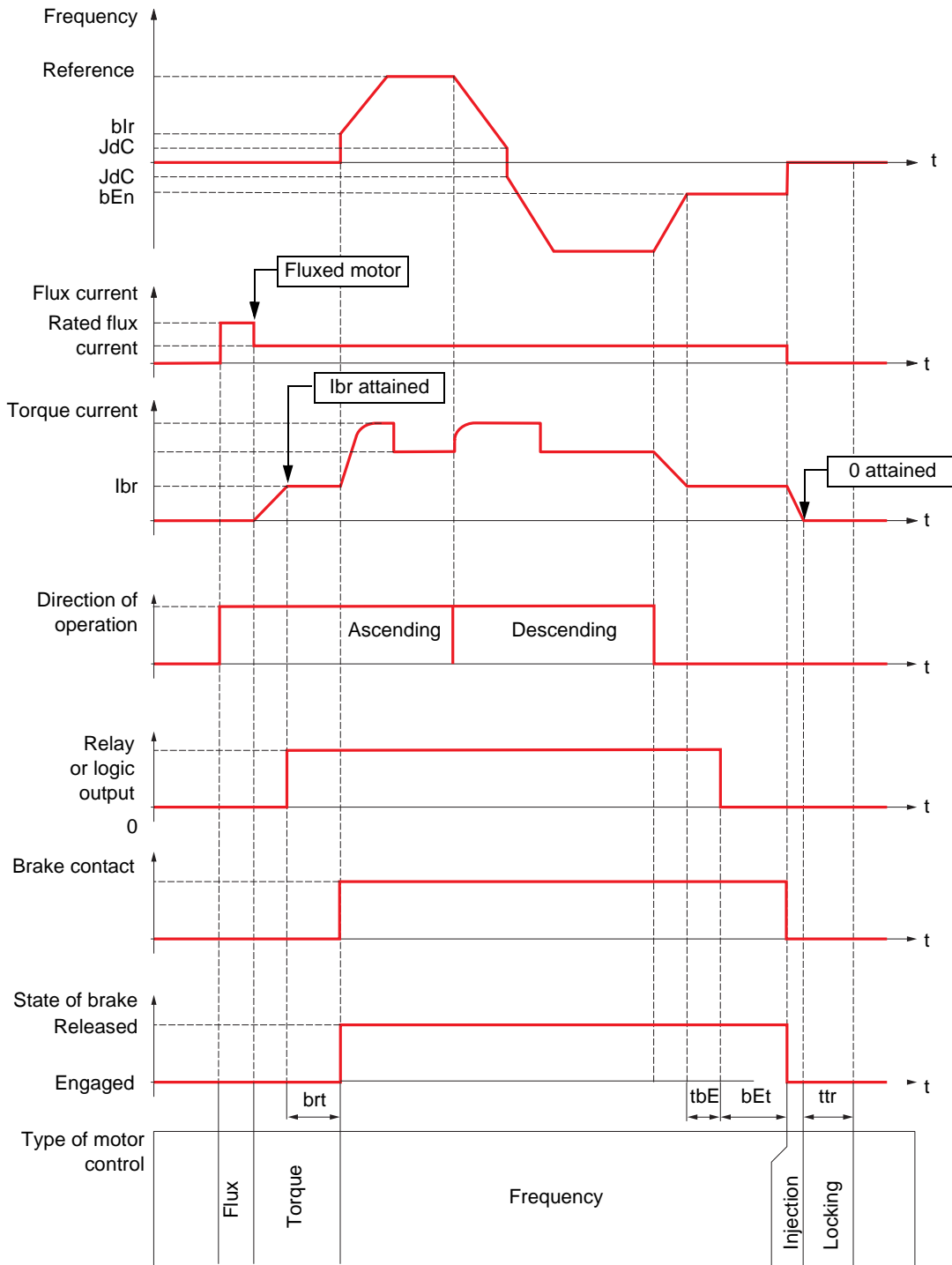

- Key:
- (bEn): [Brake engage freq]
  - (bEt): [Brake engage time]
  - (blr): [Brake release freq]
  - (brt): [Brake Release time]
  - (lbr): [Brake release I FW]
  - (JdC): [Jump at reversal]
  - (tbE): [Brake engage delay]
  - (ttr): [Time to restart]

Handling  
Lifts  
Hoisting

Brake logic control, vertical or horizontal movement in closed-loop mode

Handling

Lifts

Hoisting

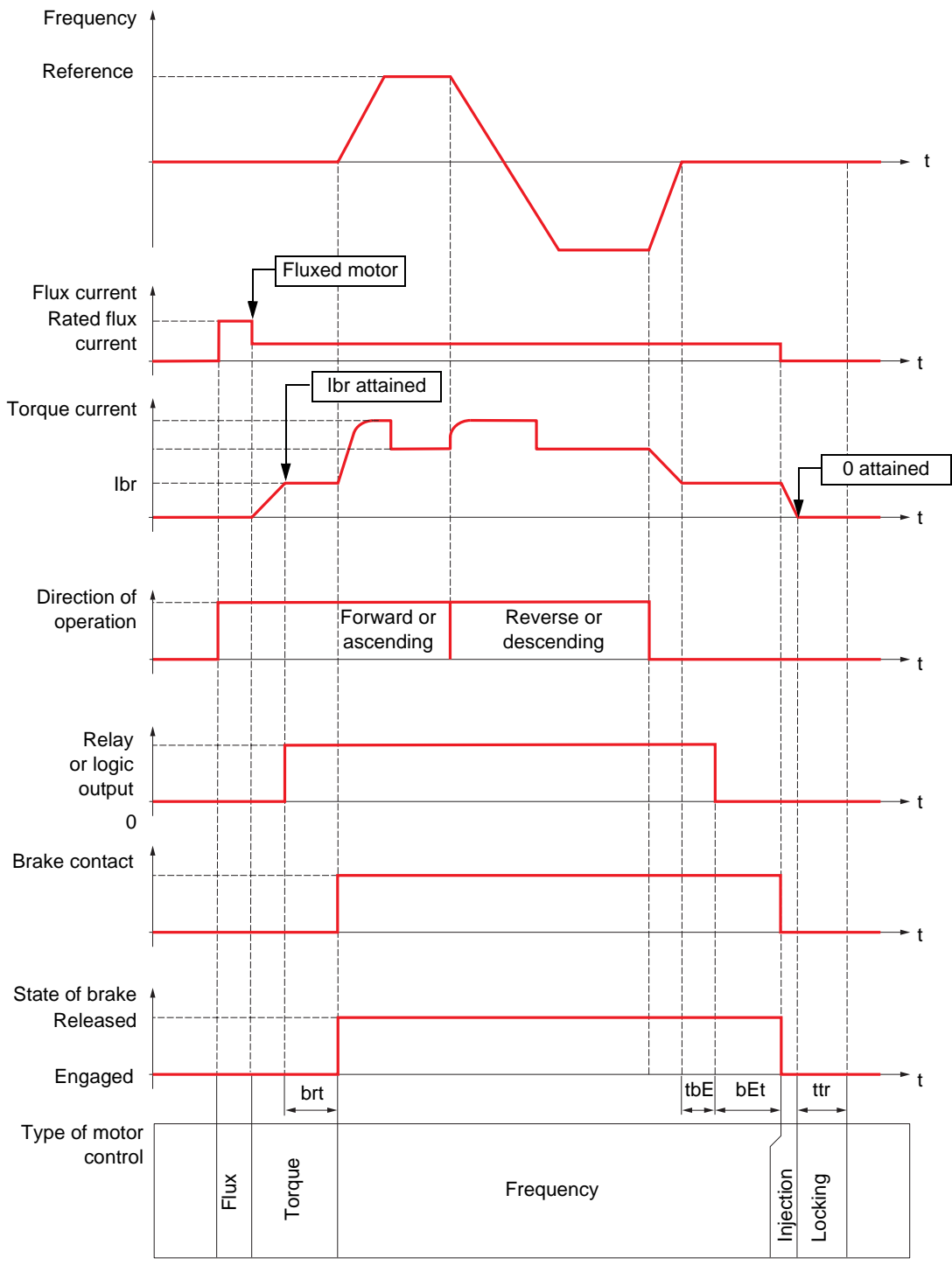

- Key:
- (bEt): [Brake engage time]
  - (brt): [Brake Release time]
  - (lbr): [Brake release I FW]
  - (tbE): [Brake engage delay]
  - (ttr): [Time to restart]

# [1.7 APPLICATION FUNCT.] (FU<sub>n</sub>-)

Handling

Lifts

Hoisting

| Code   | Name/Description   | Adjustment range             | Factory setting               |
|--|--|------------------------------|-------------------------------|
| <b>b L C -</b>   | <div style="background-color: #00b0f0; color: white; padding: 5px;"> <h2 style="margin: 0;">[ BRAKE LOGIC CONTROL ]</h2> <p> <b>Note:</b> This function cannot be used with certain other functions. Follow the instructions on page 127.</p> </div>   |                              |                               |
| <b>b L C</b>   | <input type="checkbox"/> <b>[ Brake assignment ]</b> <p> <b>Note:</b> If the brake is assigned, only a ramp stop is possible. Check the [Type of stop] (Stt) page 137.</p> <p>Brake logic control can only be assigned if [Motor control type] (Ctt) page 69 = [SVC V] (UUC), [SVC I] (CUC) or [FVC] (FUC).</p> <p>Logic output or control relay</p> <ul style="list-style-type: none"> <li><input type="checkbox"/> <b>[No]</b> (nO): Function not assigned (in this case, none of the function parameters can be accessed).</li> <li><input type="checkbox"/> <b>[R2]</b> (r2) to <b>[R4]</b> (r4): Relay (selection extended to R3 or R4 if one or two I/O cards have been inserted).</li> <li><input type="checkbox"/> <b>[LO1]</b> (LO1) to <b>[LO4]</b> (LO4): Logic output (if one or two I/O cards have been inserted, LO1 to LO2 or LO4 can be selected).</li> <li><input type="checkbox"/> <b>[dO1]</b> (dO1): Analog output AO1 functioning as a logic output. Selection can be made if [AO1 assignment] (AO1) page 108 = [No] (nO).</li> </ul> |                              | [No] (nO)                     |
| <b>b S t</b>   | <input type="checkbox"/> <b>[ Movement type ]</b> <ul style="list-style-type: none"> <li><input type="checkbox"/> <b>[Traveling]</b> (HO<sub>r</sub>): Resistive-load movement (translational motion of overhead crane, for example).</li> <li><input type="checkbox"/> <b>[Hoisting]</b> (UE<sub>r</sub>): Driving-load movement (hoisting winch, for example).</li> </ul> <p>If [Weight sensor ass.] (PES) page 163 is not [No] (nO) [Movement type] (bSt) is forced to [Hoisting] (UE<sub>r</sub>).</p>   |                              | [Hoisting] (UE <sub>r</sub> ) |
| <b>b C I</b>   | <input type="checkbox"/> <b>[ Brake contact ]</b> <p>If the brake has a monitoring contact (closed for released brake).</p> <ul style="list-style-type: none"> <li><input type="checkbox"/> <b>[No]</b> (nO): Function inactive</li> <li><input type="checkbox"/> <b>[LI1]</b> (LI1) :<br/>:<br/>:<br/><input type="checkbox"/> <b>[...]</b> (...): See the assignment conditions on page 121.</li> </ul>  |                              | [No] (nO)                     |
| <b>b I P</b><br>(C)  | <input type="checkbox"/> <b>[ Brake impulse ]</b> <p>The parameter can be accessed if [Weight sensor ass.] (PES) = [No] (nO) (see page 163) and if [Movement type] (bSt) = [Hoisting] (UE<sub>r</sub>).</p> <ul style="list-style-type: none"> <li><input type="checkbox"/> <b>[No]</b> (nO): The motor torque is given in the required operating direction, at current Ibr.</li> <li><input type="checkbox"/> <b>[Yes]</b> (YES): The motor torque is always Forward (check that this direction corresponds to ascending), at current Ibr.</li> <li><input type="checkbox"/> <b>[2 IBr]</b> (2Ibr): The torque is in the required direction, at current Ibr for Forward and Ird for Reverse, for certain specific applications.</li> </ul>  |                              | [No] (nO)                     |
| <b>I b r</b><br>(C)  | <input type="checkbox"/> <b>[ Brake release I FW ]</b> (1)   | 0 to 1.32 I <sub>n</sub> (2) | 0                             |
| Brake release current threshold for ascending or forward movement<br>The parameter can be accessed if [Weight sensor ass.] (PES) = [No] (nO) (see page 163). |  |                              |                               |
| <b>I r d</b><br>(C)  | <input type="checkbox"/> <b>[ Brake release I Rev ]</b> (1)  | 0 to 1.32 I <sub>n</sub> (2) | 0                             |
| Brake release current threshold for descending or reverse movement<br>The parameter can be accessed if [Brake impulse] (bIP) = [2 IBr] (2Ibr).               |  |                              |                               |

(1) The parameter can also be accessed in the [1.3 SETTINGS] (SE<sub>t</sub>-) menu.  
 (2) In corresponds to the rated drive current indicated in the Installation Manual and on the drive nameplate.

Parameter that can be modified during operation or when stopped.

# [1.7 APPLICATION FUNCT.] (FUn-)

Handling

Lifts

Hoisting



| Code  | Name/Description   | Adjustment range | Factory setting |
|---|--|------------------|-----------------|
| <b>■ [BRAKE LOGIC CONTROL]</b> (continued)  |  |                  |                 |
| brt<br>⌚  | <input type="checkbox"/> <b>[Brake Release time]</b> (1)<br>Brake release time delay   | 0 to 5.00 s      | 0               |
| blr<br>⌚  | <input type="checkbox"/> <b>[Brake release freq]</b> (1)<br>Brake release frequency threshold (initialization of acceleration ramp).<br>The parameter can be accessed if [Motor control type] (Ctt) page 69 is not [FVC] (FUC) and if [Movement type] (bSt) page 157 is [Hoisting] (UEr).  |                  | [Auto] (AUtO)   |
| AUtO<br>-   | <input type="checkbox"/> <b>[Auto] (AUtO)</b> : The drive takes a value equal to the rated slip of the motor, calculated using the drive parameters.<br><input type="checkbox"/> <b>0 to 10 Hz</b> : Manual control  |                  |                 |
| ben<br>⌚  | <input type="checkbox"/> <b>[Brake engage freq]</b> (1)<br>Brake engage frequency threshold<br>The parameter can be accessed if [Motor control type] (Ctt) page 69 is not [FVC] (FUC).   |                  | [Auto] (AUtO)   |
| AUtO<br>-   | <input type="checkbox"/> <b>[Auto] (AUtO)</b> : The drive takes a value equal to the rated slip of the motor, calculated using the drive parameters.<br><input type="checkbox"/> <b>0 to 10 Hz</b> : Manual control  |                  |                 |
| becd<br>nd<br>-   | <input type="checkbox"/> <b>[Brake engage at 0]</b><br>Brake engages at regulated zero speed.<br>The parameter can be accessed if [Motor control type] (Ctt) page 69 = [FVC] (FUC).<br>Can be used to engage the brake at zero speed in closed-loop mode with speed regulation. This parameter can be used to adjust the brake engage delay once zero speed has been reached.<br>If a speed other than zero is then required, the command to release the brake is sent following torque application. |                  | [No] (nO)       |
| bbe<br>⌚  | <input type="checkbox"/> <b>[Brake engage delay]</b> (1)<br>Time delay before request to engage brake. To delay brake engagement, if you wish the brake to be engaged when the drive comes to a complete stop.   | 0 to 5.00 s      | 0               |
| bet<br>⌚  | <input type="checkbox"/> <b>[Brake engage time]</b> (1)<br>Brake engage time (brake response time)   | 0 to 5.00 s      | 0               |
| sdcl<br>⌚   | <input type="checkbox"/> <b>[Auto DC inj. level 1]</b> (1)<br>Level of standstill DC injection current.<br><b>Note:</b> The parameter can be accessed if [Motor control type] (Ctt) page 69 is not [FVC] (FUC) and if [Movement type] (bSt) page 157 is [Traveling] (HOr).   | 0 to 1.2 In (2)  | 0.7 In (2)      |
| <div style="border: 1px solid black; padding: 10px; margin: 10px auto; width: 80%;"> <p style="margin: 0;"><b>CAUTION</b></p> <p style="margin: 0;">Check that the motor will withstand this current without overheating.<br/> <b>Failure to follow this instruction can result in equipment damage.</b></p> </div> |  |                  |                 |

(1) The parameter can also be accessed in the [1.3 SETTINGS] (SEt-) menu.

(2) In corresponds to the rated drive current indicated in the Installation Manual and on the drive nameplate.

Parameter that can be modified during operation or when stopped.

## [1.7 APPLICATION FUNCT.] (FUn-)

| Code   | Name/Description  | Adjustment range | Factory setting |
|--|---|------------------|-----------------|
| <b>■ [BRAKE LOGIC CONTROL]</b> (continued)   |   |                  |                 |
| <b>bEd</b><br><br><br><b>nO</b><br><b>YES</b> | <input type="checkbox"/> <b>[Engage at reversal]</b><br><br><input type="checkbox"/> <b>[No] (nO)</b> : The brake does not engage.<br><input type="checkbox"/> <b>[Yes] (YES)</b> : The brake engages.<br>Can be used to select whether or not the brake engages on transition to zero speed when the operating direction is reversed.  |                  | [No] (nO)       |
| <b>JdC</b><br><br><br><b>AUtO</b><br>-        | <input type="checkbox"/> <b>[Jump at reversal]</b> (1)<br><br>The parameter can be accessed if <b>[Motor control type] (Ctt)</b> page 69 is not <b>[FVC] (FUC)</b> and if <b>[Movement type] (bSt)</b> page 157 is <b>[Hoisting] (UEr)</b> .<br><input type="checkbox"/> <b>[Auto] (AUtO)</b> : The drive takes a value equal to the rated slip of the motor, calculated using the drive parameters.<br><input type="checkbox"/> <b>0 to 10 Hz</b> : Manual control<br>When the reference direction is reversed, this parameter can be used to avoid loss of torque (and consequential release of load) on transition to zero speed. Parameter is not applicable if <b>[Engage at reversal] (bEd) = [Yes] (YES)</b> . | 0 to 10.0 Hz     | [Auto] (AUtO)   |
| <b>tEr</b><br>                                | <input type="checkbox"/> <b>[Time to restart]</b> (1)<br><br>Time between the end of a brake engage sequence and the start of a brake release sequence  | 0 to 5.00 s      | 0               |

(1) The parameter can also be accessed in the **[1.3 SETTINGS] (SEt-)** menu.

 Parameter that can be modified during operation or when stopped.

# [1.7 APPLICATION FUNCT.] (FUn-)

## Brake control logic expert parameters

| Code                      | Name/Description   | Adjustment range | Factory setting |
|---------------------------|--|------------------|-----------------|
| <b>brH0</b><br><br>0<br>1 | <input type="checkbox"/> <b>[BRH b0]</b><br>Selection of the brake restart sequence if a run command is repeated while the brake is engaging.<br><input type="checkbox"/> <b>[0] (0)</b> : The engage/release sequence is executed in full.<br><input type="checkbox"/> <b>[1] (1)</b> : The brake is released immediately.<br><br>Use in open-loop and closed-loop mode.<br><ul style="list-style-type: none"> <li>A run command may be requested during the brake engagement phase. Whether or not the brake release sequence is executed depends on the value selected for <b>[BRH b0] (brH0)</b>.</li> </ul> |                  | 0               |
|                           | <p>Note: If a run command is requested during the "ttr" phase, the complete brake control sequence is initialized.</p>   |                  |                 |
| <b>brH1</b><br><br>0<br>1 | <input type="checkbox"/> <b>[BRH b1]</b><br>Deactivation of the brake contact in steady state fault.<br><input type="checkbox"/> <b>[0] (0)</b> : The brake contact in steady state fault is active (fault if the contact is open during operation). The brF brake contact fault is monitored in all operating phases.<br><input type="checkbox"/> <b>[1] (1)</b> : The brake contact in steady state fault is inactive. The brF brake contact fault is only monitored during the brake release and engage phases.   |                  | 0               |

Handling

Lifts

Hoisting



# [1.7 APPLICATION FUNCT.] (FUn-)

Handling  
Lifts  
Hoisting

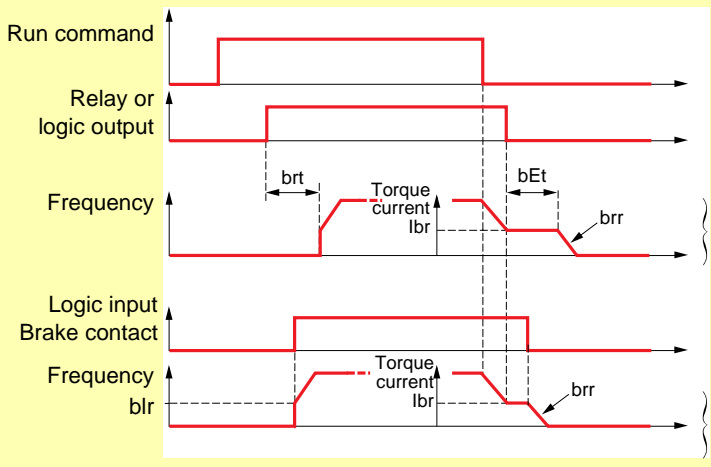
| Code   | Name/Description  | Adjustment range | Factory setting |
|--|---|------------------|-----------------|
| <b>brH2</b><br><br><input type="checkbox"/> 0<br><input type="checkbox"/> 1                                  | <input type="checkbox"/> <b>[BRH b2]</b><br><br>Taking the brake contact into account for the brake control sequence.<br><input type="checkbox"/> <b>[0]</b> (0): The brake contact is not taken into account.<br><input type="checkbox"/> <b>[1]</b> (1): The brake contact is taken into account.<br><br>Use in open-loop and closed-loop mode.<br><ul style="list-style-type: none"> <li>If a logic input is assigned to the brake contact.<br/>               [BRH b2] (brH2) = 0: During the brake release sequence, the reference is enabled at the end of the time [Brake Release time] (brt). During the brake engage sequence, the current changes to 0 according to the ramp [Current ramp time] (brr) at the end of the [Brake engage time] (bEt).<br/>               [BRH b2] (brH2) = 1: When the brake is released, the reference is enabled when the logic input changes to 1. When the brake is engaged, the current changes to 0 according to the ramp [Current ramp time] (brr) when the logic input changes to 0.</li> </ul>  |                  | 0               |
| <b>brH3</b><br><br><input type="checkbox"/> 0<br><input type="checkbox"/> 1                                  | <input type="checkbox"/> <b>[BRH b3]</b><br><br>In closed-loop mode only. Management of the absence of brake contact response, if it is assigned.<br><input type="checkbox"/> <b>[0]</b> (0): During the brake engage sequence, the brake contact must be open before the end of [Brake engage time] (bEt), otherwise the drive locks in a brF brake contact fault.<br><input type="checkbox"/> <b>[1]</b> (1): During the brake engage sequence, the brake contact must be open before the end of [Brake engage time] (bEt), otherwise a bCA brake contact alarm is triggered and zero speed is maintained.  |                  | 0               |
| <b>brH4</b><br><br><input type="checkbox"/> 0<br><input type="checkbox"/> 1                                  | <input type="checkbox"/> <b>[BRH_b4]</b><br><br>In closed-loop mode only. Activation of the speed loop at zero if a movement for which no command has been given occurs (measurement of a speed greater than a fixed min. threshold).<br><input type="checkbox"/> <b>[0]</b> (0): No action in the event of a movement for which no command has been given.<br><input type="checkbox"/> <b>[1]</b> (1): If a movement occurs for which no command has been given, the drive switches to zero speed regulation, with no brake release command, and a bSA alarm is triggered.   |                  | 0               |
| <b>brr</b><br><br><input type="checkbox"/> <b>[Current ramp time]</b><br><input checked="" type="checkbox"/> | Torque current ramp time (increase and decrease) for a current variation equal to [Brake release I FW] (lbr).   | 0 to 5.00 s      | 0 s             |

Parameter that can be modified during operation or when stopped.

## [1.7 APPLICATION FUNCT.] (FUn-)

### Load measurement

This function uses the information supplied by a weight sensor to adapt the current [Brake release I FW] (*I<sub>br</sub>*) of the [BRAKE LOGIC CONTROL] (*bLC-*) function. The signal from the weight sensor can be assigned to an analog input (usually a 4 - 20 mA signal), to the pulse-in input or to the encoder input, according to the type of weight sensor.

Examples:

- Measurement of the total weight of a hoisting winch and its load
- Measurement of the total weight of an elevator winch, the cabin and counterweight

The current [Brake release I FW] (*I<sub>br</sub>*) is adapted in accordance with the curve below.

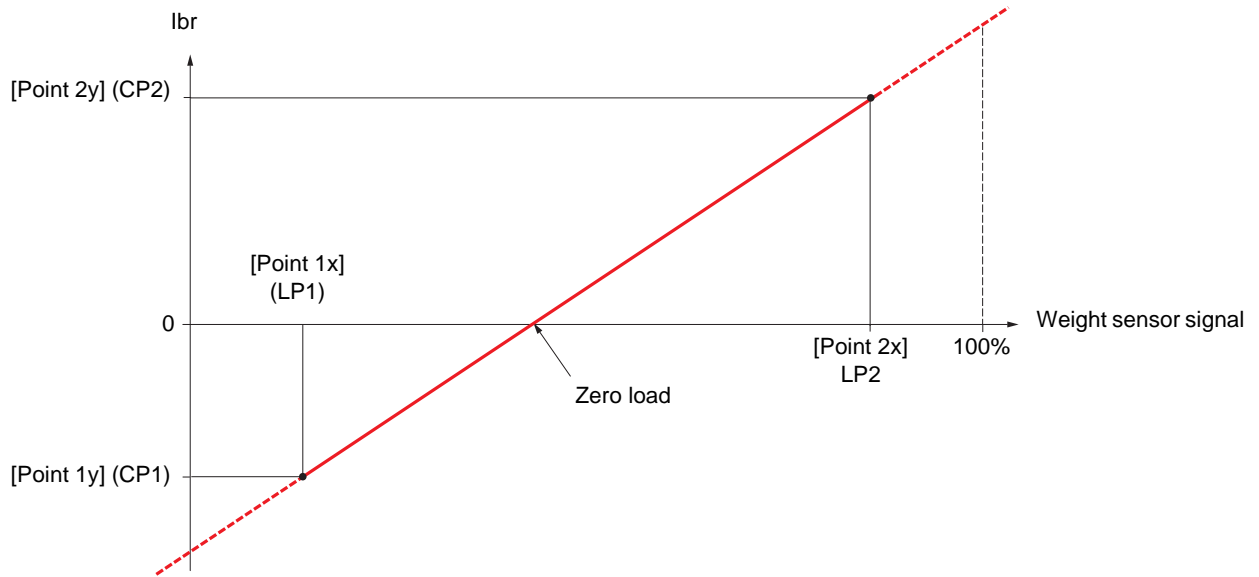



This curve can represent a weight sensor on an elevator winch, where zero load on the motor occurs when the load in the cabin is not zero.

# [1.7 APPLICATION FUNCT.] (FUn-)

Lifts

Hoisting

| Code   | Name/Description   | Adjustment range      | Factory setting |
|--|--|-----------------------|-----------------|
| <b>ELN-</b>  | <b>[EXTERNAL WEIGHT MEAS.]</b>   |                       |                 |
| <b>PES</b>   | <input type="checkbox"/> <b>[Weight sensor ass.]</b><br>Function can be accessed if brake logic control is assigned (see page 157).<br>If [Weight sensor ass.] (PES) is not [No] (nO), [Movement type] (bSt) page 157 is forced to [Hoisting] (UEr).<br><input type="checkbox"/> <b>[No] (nO)</b> : Function inactive<br><input type="checkbox"/> <b>[AI1] (AI1)</b> : Analog input<br><input type="checkbox"/> <b>[AI2] (AI2)</b> : Analog input<br><input type="checkbox"/> <b>[AI3] (AI3)</b> : Analog input, if VW3A3202 extension card has been inserted<br><input type="checkbox"/> <b>[AI4] (AI4)</b> : Analog input, if VW3A3202 extension card has been inserted<br><input type="checkbox"/> <b>[RP] (PI)</b> : Frequency input, if VW3A3202 extension card has been inserted<br><input type="checkbox"/> <b>[Encoder] (PG)</b> : Encoder input, if encoder card has been inserted<br><input type="checkbox"/> <b>[Network AI] (AIU1)</b> : Virtual input via communication bus, to be configured via [AI net. channel] (AIC1) page 95. |                       | [No] (nO)       |
|  |  <b>WARNING</b><br><b>UNINTENDED EQUIPMENT OPERATION</b><br>If the equipment switches to forced local mode (see page 237), the virtual input remains fixed at the last value transmitted.<br>Do not use the virtual input and forced local mode in the same configuration.<br><b>Failure to follow these instructions can result in death or serious injury.</b>  |                       |                 |
| <b>LP1</b>   | <input type="checkbox"/> <b>[Point 1 X]</b><br>0 to 99.99% of signal on assigned input.<br>[Point 1x] (LP1) must be less than [Point 2x] (LP2).<br>The parameter can be accessed if [Weight sensor ass.] (PES) is assigned.  | 0 to 99.99%           | 0               |
| <b>CP1</b>   | <input type="checkbox"/> <b>[Point 1Y]</b><br>Current corresponding to load [Point 1 X] (LP1), in A.<br>The parameter can be accessed if [Weight sensor ass.] (PES) is assigned.   | -1.36 to +1.36 In (1) | - In            |
| <b>LP2</b>   | <input type="checkbox"/> <b>[Point 2X]</b><br>0.01 to 100% of signal on assigned input.<br>[Point 2x] (LP2) must be greater than [Point 1x] (LP1).<br>The parameter can be accessed if [Weight sensor ass.] (PES) is assigned.   | 0.01 to 100%          | 50%             |
| <b>CP2</b>   | <input type="checkbox"/> <b>[Point 2Y]</b><br>Current corresponding to load [Point 2x] (LP2), in A.<br>The parameter can be accessed if [Weight sensor ass.] (PES) is assigned.  | -1.36 to +1.36 In (1) | 0               |
| <b>IBrA</b><br> | <input type="checkbox"/> <b>[Ibr 4-20 mA loss]</b><br>Brake release current in the event of the loss of the weight sensor information.<br>This parameter can be accessed if the weight sensor is assigned to an analog current input and the 4-20 mA loss fault is deactivated.<br>Recommended settings:<br>- 0 for elevators<br>- Rated motor current for a hoisting application  | 0 to 1.36 In (1)      | 0               |

(1) In corresponds to the rated drive current indicated in the Installation Manual and on the drive nameplate.

 Parameter that can be modified during operation or when stopped.

## High-speed hoisting

This function can be used to optimize the cycle times for hoisting movements for zero or lightweight loads. It authorizes operation at "constant power" in order to reach a speed greater than the rated speed without exceeding the rated motor current. The speed remains limited by the [High speed] (HSP) parameter, page 42.

The function acts on the speed reference pedestal and not on the reference itself.

### Principle:

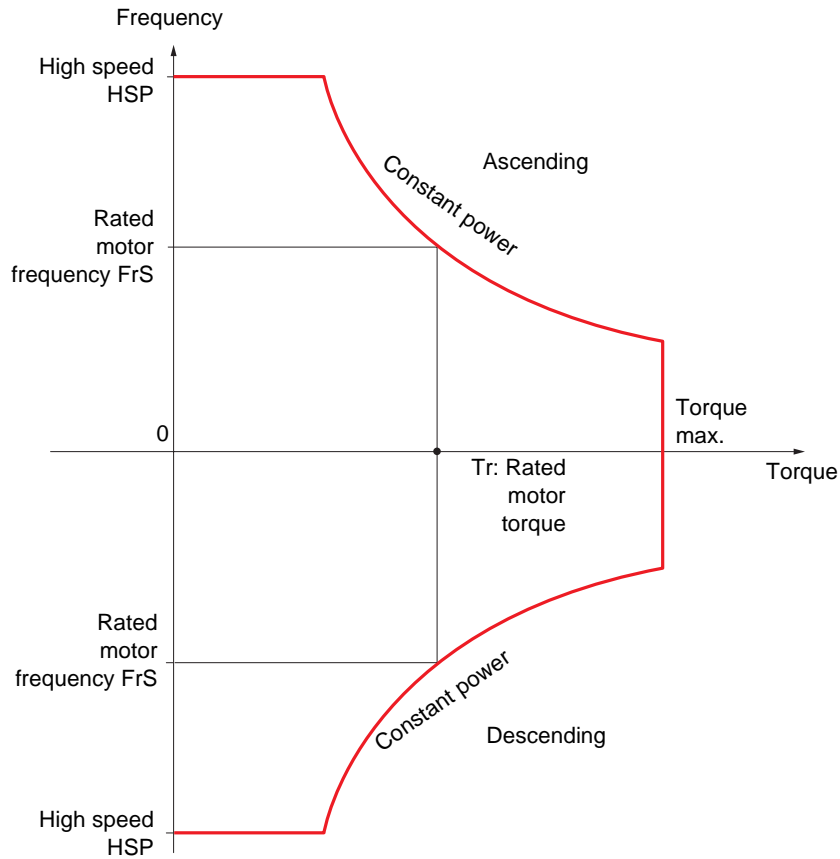

## [1.7 APPLICATION FUNCT.] (FUn-)

There are 2 possible operating modes:

- "Speed reference" mode: The maximum permissible speed is calculated by the drive during a speed step that is set so that the drive can measure the load.
- "Current limitation" mode: The maximum permissible speed is the speed that supports current limitation in motor mode, in the "Ascending" direction only. For the "Descending" direction, operation is always in "Speed reference" mode.

### Speed reference mode

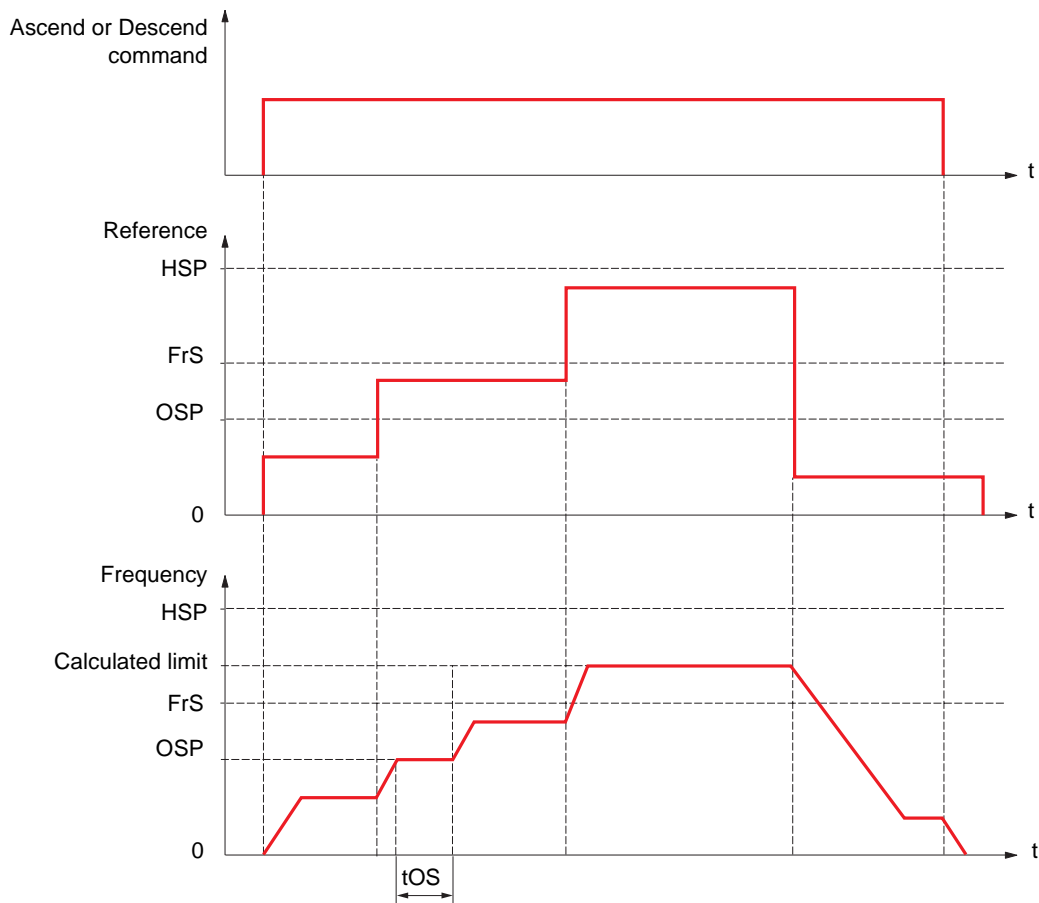

OSP: Adjustable speed step for load measurement

tOS: Load measuring time

Two parameters are used to reduce the speed calculated by the drive, for ascending and descending.

### Current limiting mode

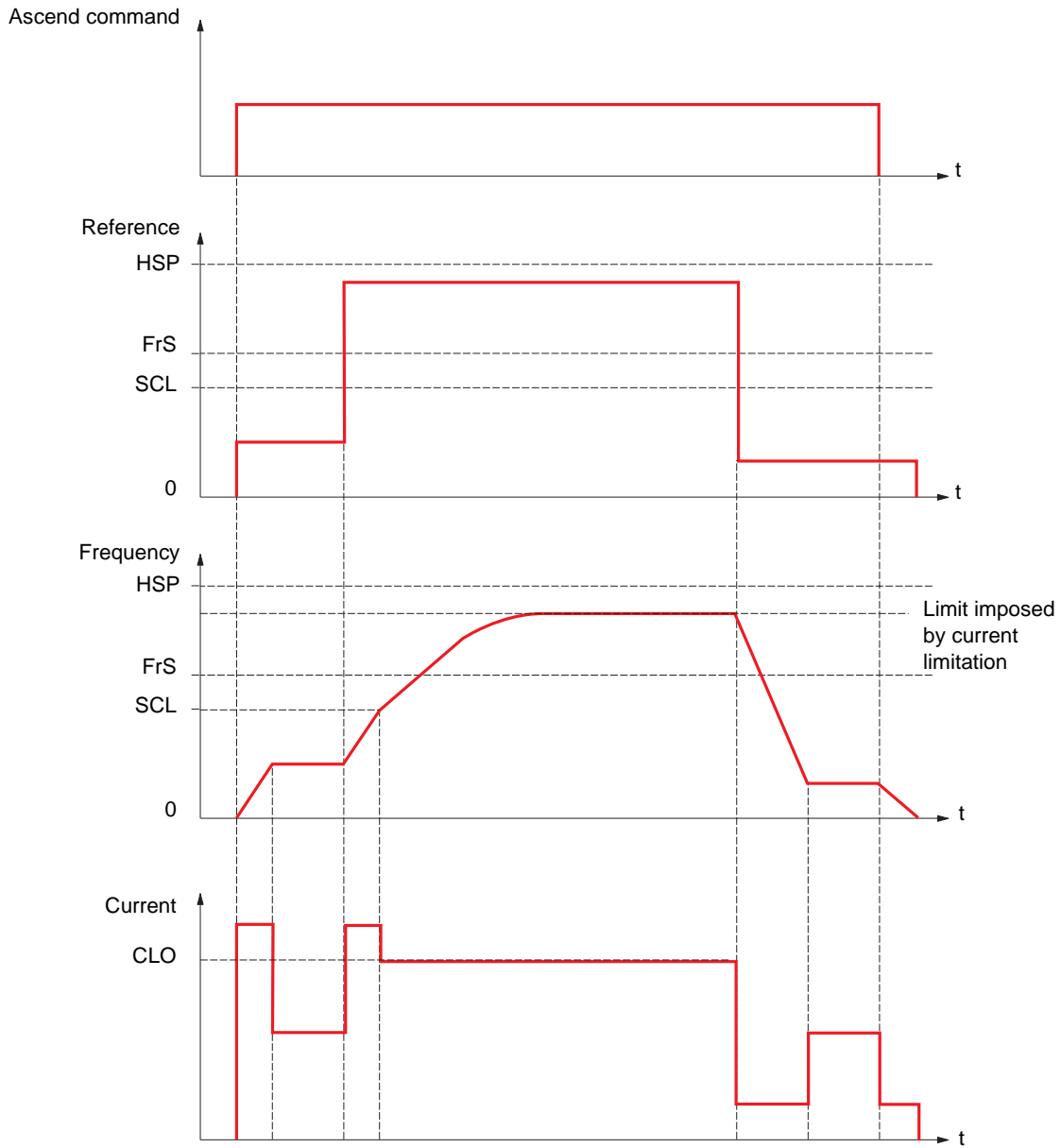

SCL: Adjustable speed threshold, above which current limitation is active  
CLO: Current limitation for high-speed function

### Rope slack

The "rope slack" function can be used to prevent starting up at high speed when a load has been set down ready for lifting but the rope is still slack (as illustrated below).

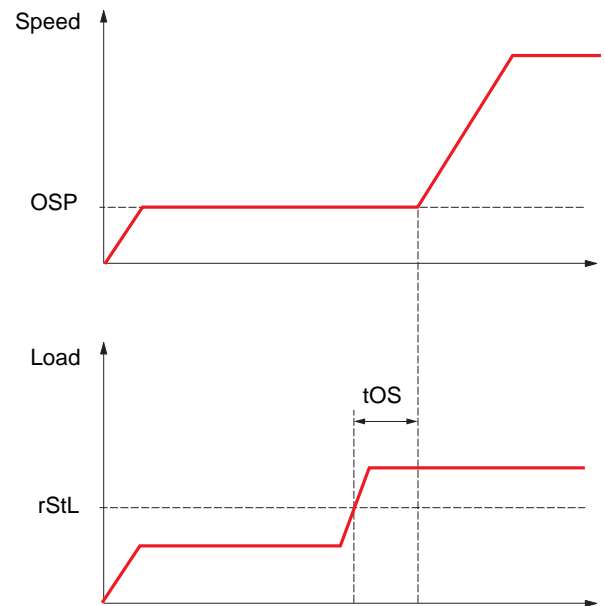
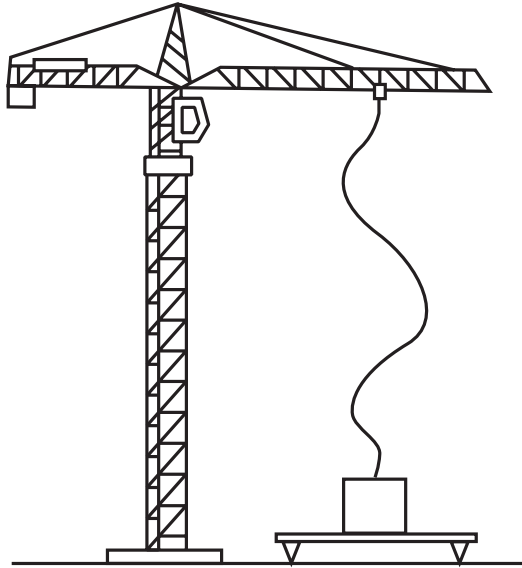

The speed step (OSP parameters) described on page 165 is used to measure the load. The effective measurement cycle will not be triggered until the load reaches the adjustable threshold rStL, which corresponds to the weight of the hook.

A logic output or a relay can be assigned to the indication of the "rope slack" state in the [1.5 INPUTS / OUTPUTS CFG] (I-O-) menu.

# [1.7 APPLICATION FUNCT.] (FUn-)

Hoisting

| Code  | Name/Description  | Adjustment range                        | Factory setting |
|---|---|---|-----------------|
| <b>HSH -</b>  | <div style="background-color: #00FFFF; padding: 5px;"> <p><b>[HIGH SPEED HOISTING]</b></p> <p> <b>Note:</b> This function cannot be used with certain other functions. Follow the instructions on page <a href="#">127</a>.</p> </div>  |   |                 |
| <b>HSD</b><br><i>nD</i><br><b>SSD</b><br><i>CSO</i> | <input type="checkbox"/> <b>[High speed hoisting]</b><br><input type="checkbox"/> <b>[No] (nO)</b> : Function inactive<br><input type="checkbox"/> <b>[Speed ref] (SSO)</b> : "Speed reference" mode<br><input type="checkbox"/> <b>[I Limit] (CSO)</b> : "Current limitation" mode   |   | [No] (nO)       |
| <b>COF</b><br>                                      | <input type="checkbox"/> <b>[Motor speed coeff.]</b><br>Speed reduction coefficient calculated by the drive for Ascending direction.<br>The parameter can be accessed if <b>[High speed hoisting] (HSO)</b> = <b>[Speed ref] (SSO)</b> .  | 0 to 100%                               | 100%            |
| <b>COr</b><br>                                      | <input type="checkbox"/> <b>[Gen. speed coeff]</b><br>Speed reduction coefficient calculated by the drive for Descending direction.<br>The parameter can be accessed if <b>[High speed hoisting] (HSO)</b> is not <b>[No] (nO)</b> .  | 0 to 100%                               | 50%             |
| <b>LOS</b><br>                                      | <input type="checkbox"/> <b>[Load measuring tm.]</b><br>Duration of speed step for measurement.<br>The parameter can be accessed if <b>[High speed hoisting] (HSO)</b> is not <b>[No] (nO)</b> .  | 0.1 s to 65 s                           | 0.5 s           |
| <b>OSP</b><br>                                      | <input type="checkbox"/> <b>[Measurement spd]</b><br>Speed stabilized for measurement.<br>The parameter can be accessed if <b>[High speed hoisting] (HSO)</b> is not <b>[No] (nO)</b> .   | 0 to <b>[Rated motor freq.] (FrS)</b>   | 40 Hz           |
| <b>CLD</b><br>                                      | <input type="checkbox"/> <b>[High speed I Limit]</b><br>Current limitation at high speed.<br>The parameter can be accessed if <b>[High speed hoisting] (HSO)</b> = <b>[I Limit] (CSO)</b> .<br>The adjustment range is limited to 1.36 In if <b>[Switching freq.](SFr)</b> page <a href="#">59</a> is less than 2 kHz.<br><b>Note:</b> If the setting is less than 0.25 In, the drive may lock in <b>[Output Phase Loss] (OPF)</b> fault mode if this has been enabled (see page <a href="#">217</a> ).   | 0 to 1.65 In (1)                        | In              |
| <b>SCL</b><br>                                      | <input type="checkbox"/> <b>[I Limit. frequency]</b><br>Frequency threshold, above which the high-speed limitation current is active.<br>The parameter can be accessed if <b>[High speed hoisting] (HSO)</b> = <b>[I Limit] (CSO)</b>   | 0 to 500 or 1600 Hz according to rating | 40 Hz           |
| <b>rSd</b><br><i>nD</i><br><i>drl</i><br><b>PES</b> | <input type="checkbox"/> <b>[Rope slack config.]</b><br>Rope slack function. The parameter can be accessed if <b>[High speed hoisting] (HSO)</b> is not <b>[No] (nO)</b> .<br><input type="checkbox"/> <b>[No] (nO)</b> : Function inactive<br><input type="checkbox"/> <b>[Drive estim.] (drl)</b> : Measurement of the load by estimating the torque generated by the drive.<br><input type="checkbox"/> <b>[Ext. sensor] (PES)</b> : Measurement of the load using a weight sensor, can only be assigned if <b>[Weight sensor ass.] (PES)</b> page <a href="#">163</a> is not <b>[No] (nO)</b> . |   | [No] (nO)       |
| <b>rSEL</b>   | <input type="checkbox"/> <b>[Rope slack trq level]</b><br>Adjustment threshold corresponding to a load weighing slightly less than the hook when off-load, as a % of the rated load.<br>The parameter can be accessed if <b>[Rope slack trq level] (rSd)</b> has been assigned.   | 0 to 100%                               | 0%              |

(1) In corresponds to the rated drive current indicated in the Installation Manual and on the drive nameplate.

Parameter that can be modified during operation or when stopped.



## PID regulator

### Block diagram

The function is activated by assigning an analog input to the PID feedback (measurement).

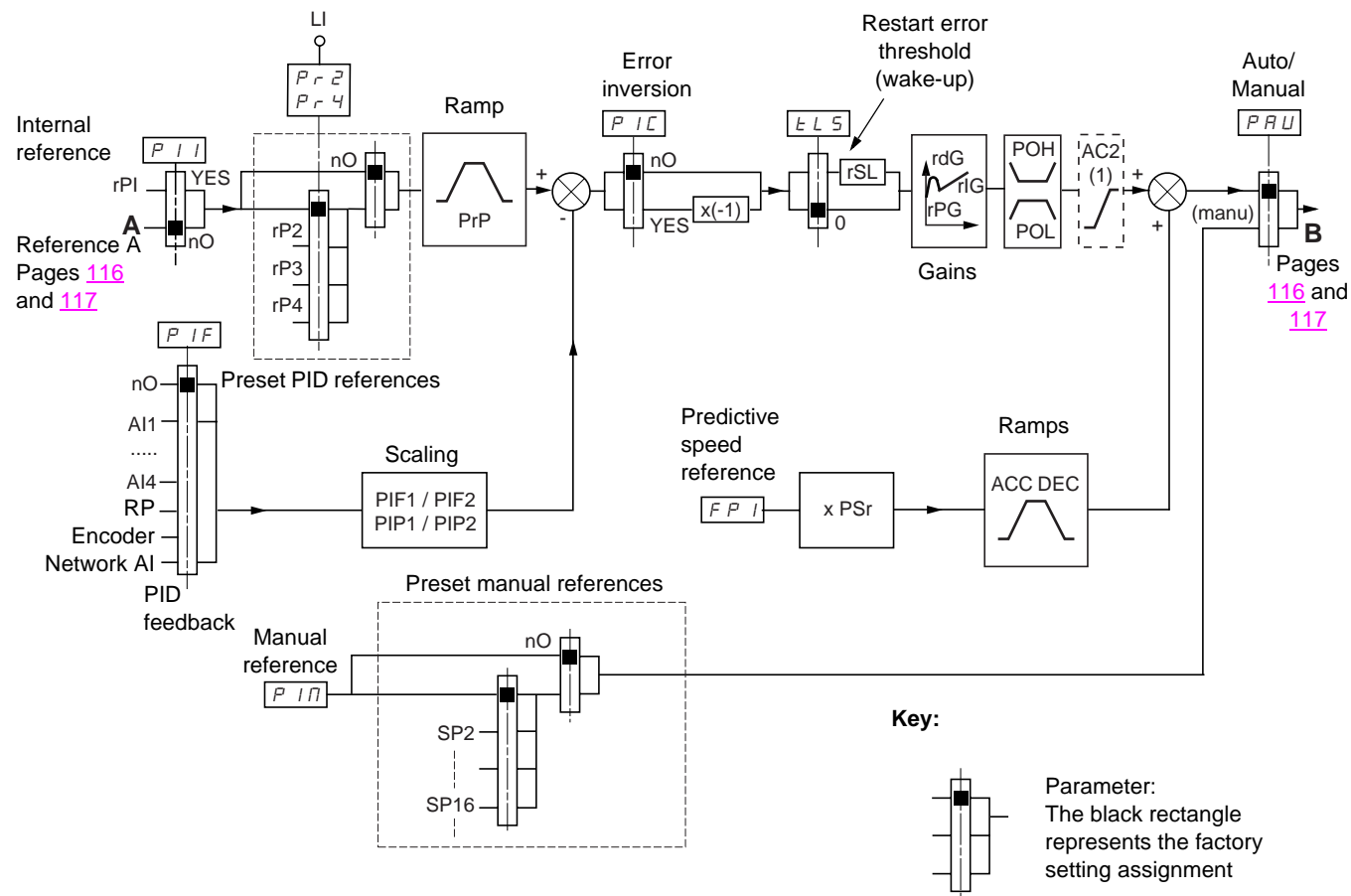

(1) Ramp AC2 is only active when the PID function starts up and during PID "wake-ups".

#### PID feedback:

The PID feedback must be assigned to one of the analog inputs AI1 to AI4, to the frequency input or the encoder, according to whether any extension cards have been inserted.

#### PID reference:

The PID reference must be assigned to the following parameters:

- Preset references via logic inputs (rP2, rP3, rP4)
- In accordance with the configuration of [Act. internal PID ref.] (PII) pages 173:
  - Internal reference (rPI) or
  - Reference A (Fr1 or Fr1b, see page 116)

Combination table for preset PID references

| LI (Pr4) | LI (Pr2) | Pr2 = nO | Reference |
|----------|----------|----------|-----------|
|          |          |          | rPI or A  |
| 0        | 0        |          | rPI or A  |
| 0        | 1        |          | rP2       |
| 1        | 0        |          | rP3       |
| 1        | 1        |          | rP4       |

A predictive speed reference can be used to initialize the speed on restarting the process.

## [1.7 APPLICATION FUNCT.] (FUn-)

### Scaling of feedback and references:

- PIF1, PIF2 parameters  
Can be used to scale the PID feedback (sensor range).  
This scale **MUST** be maintained for all other parameters.
- PIP1, PIP2 parameters  
Can be used to scale the adjustment range, i.e., the reference. **The adjustment range MUST lie within the sensor range.**

The maximum value of the scaling parameters is 32767. To facilitate installation, we recommend using values as close as possible to this maximum level, while retaining powers of 10 in relation to the actual values.

**Example** (see graph below): Adjustment of the volume in a tank, between 6 m<sup>3</sup> and 15 m<sup>3</sup>.

- Sensor used 4-20 mA, 4.5 m<sup>3</sup> for 4 mA, 20 m<sup>3</sup> for 20 mA, with the result that PIF1 = 4500 and PIF2 = 20000.
- Adjustment range 6 to 15 m<sup>3</sup>, with the result that PIP1 = 6000 (min. reference) and PIP2 = 15000 (max. reference).
- Example references:
  - rP1 (internal reference) = 9500
  - rp2 (preset reference) = 6500
  - rP3 (preset reference) = 8000
  - rP4 (preset reference) = 11200

The [DISPLAY CONFIG.] menu can be used to customize the name of the unit displayed and its format.

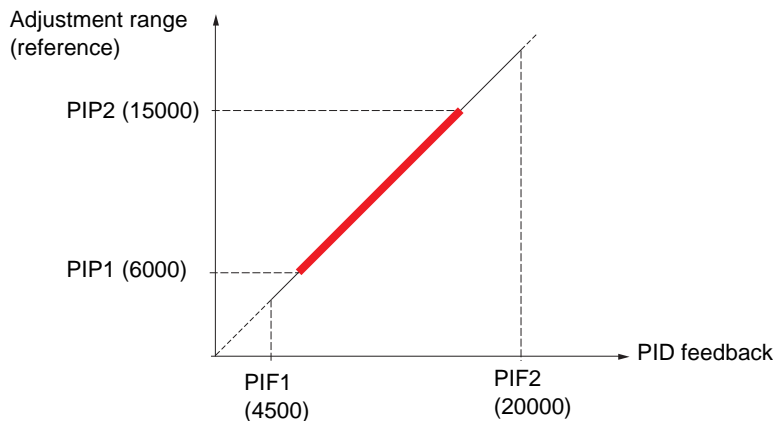

### Other parameters:

- rSL parameter:  
Can be used to set the PID error threshold, above which the PID regulator will be reactivated (wake-up) after a stop due to the max. time threshold being exceeded at low speed (tLS).
- Reversal of the direction of correction (PIC): If PIC = nO, the speed of the motor will increase when the error is positive, for example: pressure control with a compressor. If PIC = YES, the speed of the motor will decrease when the error is positive, for example: temperature control using a cooling fan.
- The integral gain may be short-circuited by a logic input.
- An alarm on the PID feedback may be configured and indicated by a logic output.
- An alarm on the PID error may be configured and indicated by a logic output.

### "Manual - Automatic" operation with PID

This function combines the PID regulator, the preset speeds and a manual reference. Depending on the state of the logic input, the speed reference is given by the preset speeds or by a manual reference input via the PID function.

#### Manual reference (PIM)

- Analog inputs AI1 to AI4
- Frequency input
- Encoder

#### Predictive speed reference (FPI)

- [AI1] (AI1): Analog input
- [AI2] (AI2): Analog input
- [AI3] (AI3): Analog input, if VW3A3202 extension card has been inserted
- [AI4] (AI4): Analog input, if VW3A3202 extension card has been inserted
- [RP] (PI): Frequency input, if VW3A3202 extension card has been inserted
- [Encoder] (PG): Encoder input, if encoder card has been inserted
- [HMI] (LCC): Graphic display terminal
- [Modbus] (Mdb): Integrated Modbus
- [CANopen] (CAn): Integrated CANopen
- [Com. card] (nEt): Communication card (if inserted)
- [C.Insid. card] (APP): Controller Inside card (if inserted)

### Setting up the PID regulator

#### 1. Configuration in PID mode

See the diagram on page [169](#).

#### 2. Perform a test in factory settings mode (in most cases, this will be sufficient).

To optimize the drive, adjust rPG or rIG gradually and independently and observe the effect on the PID feedback in relation to the reference.

#### 3. If the factory settings are unstable or the reference is incorrect

- Perform a test with a speed reference in Manual mode (without PID regulator) and with the drive on load for the speed range of the system:
  - In steady state, the speed must be stable and comply with the reference and the PID feedback signal must be stable.
  - In transient state, the speed must follow the ramp and stabilize quickly, and the PID feedback must follow the speed.If this is not the case, see the settings for the drive and/or sensor signal and wiring.
- Switch to PID mode.
- Set brA to no (no auto-adaptation of the ramp).
- Set the PID ramp (PrP) to the minimum permitted by the mechanism without triggering an ObF fault.
- Set the integral gain (rIG) to minimum.
- Leave the derivative gain (rdG) at 0.
- Observe the PID feedback and the reference.
- Switch the drive ON/OFF a number of times or vary the load or reference rapidly a number of times.
- Set the proportional gain (rPG) in order to ascertain the best compromise between response time and stability in transient phases (slight overshoot and 1 to 2 oscillations before stabilizing).
- If the reference varies from the preset value in steady state, gradually increase the integral gain (rIG), reduce the proportional gain (rPG) in the event of instability (pump applications), find a compromise between response time and static precision (see diagram).
- Lastly, the derivative gain may permit the overshoot to be reduced and the response time to be improved, although this will make it more difficult to obtain a compromise in terms of stability, as it depends on 3 gains.
- Perform in-production tests over the whole reference range.

# [1.7 APPLICATION FUNCT.] (FUn-)

Process

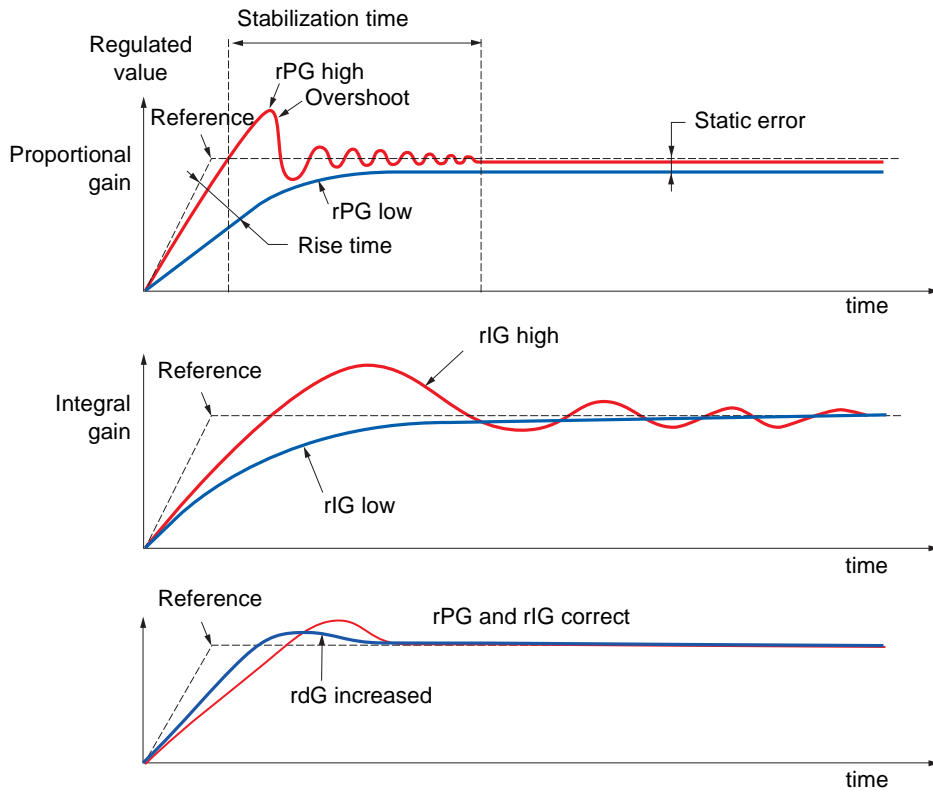

The oscillation frequency depends on the system kinematics.

| Parameter | Rise time | Overshoot | Stabilization time | Static error |
|-----------|-----------|-----------|--------------------|--------------|
| rPG ↗     | ↘↘        | ↗         | =                  | ↘            |
| rIG ↗     | ↘         | ↗↗        | ↗                  | ↘↘           |
| rdG ↗     | =         | ↘         | ↘                  | =            |

# [1.7 APPLICATION FUNCT.] (FUn-)

| Code               | Name/Description  | Adjustment range | Factory setting |
|--------------------|---|------------------|-----------------|
| <b>P Id -</b>      | <div style="background-color: #00b0f0; color: white; padding: 5px;"> <b>[PID REGULATOR]</b><br/> <b>Note:</b> This function cannot be used with certain other functions. Follow the instructions on page 127.                 </div>  |                  |                 |
| <b>P I F</b>       | <input type="checkbox"/> <b>[PID feedback ass.]</b><br><br><input type="checkbox"/> <b>[No] (nO):</b> Not assigned (function inactive) In this case, none of the function parameters can be accessed.<br><input type="checkbox"/> <b>[AI1] (AI1):</b> Analog input<br><input type="checkbox"/> <b>[AI2] (AI2):</b> Analog input<br><input type="checkbox"/> <b>[AI3] (AI3):</b> Analog input, if VW3A3202 extension card has been inserted<br><input type="checkbox"/> <b>[AI4] (AI4):</b> Analog input, if VW3A3202 extension card has been inserted<br><input type="checkbox"/> <b>[RP] (PI):</b> Frequency input, if VW3A3202 extension card has been inserted<br><input type="checkbox"/> <b>[Encoder] (PG):</b> Encoder input, if encoder card has been inserted<br><input type="checkbox"/> <b>[Network AI] (AIU1):</b> Virtual input via communication bus<br><br><b>Note:</b> If the equipment switches to forced local mode (see page 237), the virtual input remains fixed at the last value transmitted. |                  | [No] (nO)       |
| <b>A I C 1</b>     | <input type="checkbox"/> <b>[AI net. channel]</b><br><br>The parameter can be accessed if [PID feedback ass.] (PIF) = [Network AI] (AIU1). This parameter can also be accessed in the [1.5 INPUTS / OUTPUTS CFG] (I-O-) menu.<br><br><input type="checkbox"/> <b>[No] (nO): Not assigned</b><br><input type="checkbox"/> <b>[Modbus] (Mdb):</b> Integrated Modbus<br><input type="checkbox"/> <b>[CANopen] (CA n):</b> Integrated CANopen<br><input type="checkbox"/> <b>[Com. card] (nEt):</b> Communication card (if inserted)<br><input type="checkbox"/> <b>[C.Insid. card] (APP):</b> Controller Inside card (if inserted)   |                  | [No] (nO)       |
| <b>P I F 1</b><br> | <input type="checkbox"/> <b>[Min PID feedback]</b> (1)<br><br>Value for minimum feedback. Adjustment range from 0 to [Max PID feedback] (PIF2) (2).   |                  | 100             |
| <b>P I F 2</b><br> | <input type="checkbox"/> <b>[Max PID feedback]</b> (1)<br><br>Value for maximum feedback Adjustment range from [Min PID feedback] (PIF1) to 32767 (2).  |                  | 1000            |
| <b>P I P 1</b><br> | <input type="checkbox"/> <b>[Min PID reference]</b> (1)<br><br>Minimum process value. Adjustment range from [Min PID feedback] (PIF1) to [Max PID reference] (PIP2) (2).  |                  | 150             |
| <b>P I P 2</b>     | <input type="checkbox"/> <b>[Max PID reference]</b> (1)<br><br>Maximum process value Adjustment range from [Min PID reference] (PIP1) to [Max PID feedback] (PIF2) (2).   |                  | 900             |
| <b>P I I</b>       | <input type="checkbox"/> <b>[Act. internal PID ref.]</b><br><br>Internal PID regulator reference<br><input type="checkbox"/> <b>[No] (nO):</b> The PID regulator reference is given by Fr1 or Fr1b with summing/subtraction/multiplication functions (see the diagram on page 115).<br><input type="checkbox"/> <b>[Yes] (YES):</b> The PID regulator reference is internal via parameter rPI.  |                  | [No] (nO)       |
| <b>r P I</b><br>   | <input type="checkbox"/> <b>[Internal PID ref.]</b><br><br>Internal PID regulator reference This parameter can also be accessed in the [1.2 MONITORING] (SUP-) menu. Adjustment range from [Min PID reference] (PIP1) to [Max PID reference] (PIP2) (2).  |                  | 150             |
| <b>r P G</b><br>   | <input type="checkbox"/> <b>[PID prop. gain]</b><br><br>Proportional gain   | 0.01 to 100      | 1               |

(1) The parameter can also be accessed in the [1.3 SETTINGS] (SEt-) menu.

(2) If a graphic display terminal is not in use, values greater than 9999 will be displayed on the 4-digit display with a period mark after the thousand digit, e.g., 15.65 for 15650.

Parameter that can be modified during operation or when stopped.

# [1.7 APPLICATION FUNCT.] (FUn-)

Process



| Code  | Name/Description  | Adjustment range                                  | Factory setting  |
|---|---|---|------------------|
| <b>■ [PID REGULATOR] (continued)</b>          |   |   |                  |
| <b>r IG</b><br>Ⓢ                              | <input type="checkbox"/> <b>[PID integral gain]</b><br>Integral gain  | 0.01 to 100                                       | 1                |
| <b>r dG</b><br>Ⓢ                              | <input type="checkbox"/> <b>[PID derivative gain]</b><br>Derivative gain  | 0.00 to 100                                       | 0                |
| <b>P r P</b><br>Ⓢ                             | <input type="checkbox"/> <b>[PID ramp]</b> (1)<br>PID acceleration/deceleration ramp, defined to go from <b>[Min PID reference] (PIP1)</b> to <b>[Max PID reference] (PIP2)</b> and vice versa.   | 0 to 99.9 s                                       | 0 s              |
| <b>P IC</b><br><br>nO<br>YES                  | <input type="checkbox"/> <b>[PID correct. reverse]</b><br><input type="checkbox"/> <b>[No] (nO)</b><br><input type="checkbox"/> <b>[Yes] (YES)</b><br>Reversal of the direction of correction (PIC):<br>If PIC = nO, the speed of the motor will increase when the error is positive. Example: pressure control with a compressor.<br>If PIC = YES, the speed of the motor will decrease when the error is positive. Example: temperature control using a cooling fan.      |   | <b>[No] (nO)</b> |
| <b>P DL</b><br>Ⓢ                              | <input type="checkbox"/> <b>[Min PID output]</b> (1)<br>Minimum value of regulator output in Hz   | - 500 to 500 or -1600 to 1600 according to rating | 0 Hz             |
| <b>P DH</b><br>Ⓢ                              | <input type="checkbox"/> <b>[Max PID output]</b> (1)<br>Maximum value of regulator output in Hz   | 0 to 500 or 1600 according to rating              | 60 Hz            |
| <b>P AL</b><br>Ⓢ                              | <input type="checkbox"/> <b>[Min fbk alarm]</b> (1)<br>Minimum monitoring threshold for regulator feedback<br>Adjustment range from <b>[Min PID feedback] (PIF1)</b> to <b>[Max PID feedback] (PIF2)</b> (2).   |   | 100              |
| <b>P AH</b><br>Ⓢ                              | <input type="checkbox"/> <b>[Max fbk alarm]</b> (1)<br>Maximum monitoring threshold for regulator feedback<br>Adjustment range from <b>[Min PID feedback] (PIF1)</b> to <b>[Max PID feedback] (PIF2)</b> (2).   |   | 1000             |
| <b>P E r</b><br>Ⓢ                             | <input type="checkbox"/> <b>[PID error Alarm]</b> (1)<br>Regulator error monitoring threshold   | 0 to 65535 (2)                                    | 100              |
| <b>P IS</b><br><br>nO<br>L I I<br>-<br>-<br>- | <input type="checkbox"/> <b>[PID integral reset]</b><br><input type="checkbox"/> <b>[No] (nO)</b> : Function inactive<br><input type="checkbox"/> <b>[LI1] (LI1)</b><br>:<br>:<br><input type="checkbox"/> <b>[...] (...)</b> : See the assignment conditions on page 121.<br>If the assigned input or bit is at 0, the function is inactive (the PID integral is enabled).<br>If the assigned input or bit is at 1, the function is active (the PID integral is disabled). |   | <b>[No] (nO)</b> |

(1) The parameter can also be accessed in the **[1.3 SETTINGS] (SEt-)** menu.

(2) If a graphic display terminal is not in use, values greater than 9999 will be displayed on the 4-digit display with a period mark after the thousand digit, e.g., 15.65 for 15650.

Ⓢ Parameter that can be modified during operation or when stopped.

# [1.7 APPLICATION FUNCT.] (FUn-)

| Code  | Name/Description   | Adjustment range   | Factory setting |
|---|--|--------------------|-----------------|
| <b>[PID REGULATOR]</b> (continued)  |  |                    |                 |
| <b>FPI</b><br><br><i>nD</i><br><b>A11</b><br><b>A12</b><br><b>A13</b><br><b>A14</b><br><b>LCC</b><br><b>Mdb</b><br><b>CAn</b><br><i>nEt</i><br><b>APP</b><br><b>PI</b><br><b>PG</b> | <input type="checkbox"/> <b>[Speed ref. assign.]</b><br><br>PID regulator predictive speed input<br><input type="checkbox"/> <b>[No]</b> (nO): Not assigned (function inactive)<br><input type="checkbox"/> <b>[AI1]</b> (AI1): Analog input<br><input type="checkbox"/> <b>[AI2]</b> (AI2): Analog input<br><input type="checkbox"/> <b>[AI3]</b> (AI3): Analog input, if VW3A3202 extension card has been inserted<br><input type="checkbox"/> <b>[AI4]</b> (AI4): Analog input, if VW3A3202 extension card has been inserted<br><input type="checkbox"/> <b>[HMI]</b> (LCC): Graphic display terminal<br><input type="checkbox"/> <b>[Modbus]</b> (Mdb): Integrated Modbus<br><input type="checkbox"/> <b>[CANopen]</b> (CAn): Integrated CANopen<br><input type="checkbox"/> <b>[Com. card]</b> (nEt): Communication card (if inserted)<br><input type="checkbox"/> <b>[C.Insid. card]</b> (APP): Controller Inside card (if inserted)<br><input type="checkbox"/> <b>[RP]</b> (PI): Frequency input, if VW3A3202 extension card has been inserted<br><input type="checkbox"/> <b>[Encoder]</b> (PG): Encoder input, if encoder card has been inserted |                    | [No] (nO)       |
| <b>PSr</b><br>   | <input type="checkbox"/> <b>[Speed input %]</b> (1)<br><br>Multiplying coefficient for predictive speed input.<br>The parameter cannot be accessed if <b>[Speed ref. assign.]</b> (FPI) = <b>[No]</b> (nO).  | 1 to 100%          | 100%            |
| <b>PAU</b><br><br><i>nD</i><br><b>L11</b><br>-<br>-<br>-  | <input type="checkbox"/> <b>[Auto/Manual assign.]</b><br><br><input type="checkbox"/> <b>[No]</b> (nO): The PID is always active.<br><input type="checkbox"/> <b>[LI1]</b> (LI1)<br>:<br>:<br><input type="checkbox"/> <b>[...]</b> (...): See the assignment conditions on page 121.<br>If the assigned input or bit is at 0, the PID is active.<br>If the assigned input or bit is at 1, manual operation is active.   |                    | [No] (nO)       |
| <b>AC2</b><br>   | <input type="checkbox"/> <b>[Acceleration 2]</b> (1)<br><br>Time to accelerate from 0 to the <b>[Rated motor freq.]</b> (FrS). Make sure that this value is compatible with the inertia being driven.<br>Ramp AC2 is only active when the PID function starts up and during PID "wake-ups".  | 0.01 to 6000 s (3) | 5.0 s           |
| <b>PIπ</b><br><br><i>nD</i><br><b>A11</b><br><b>A12</b><br><b>A13</b><br><b>A14</b><br><b>PI</b><br><b>PG</b>   | <input type="checkbox"/> <b>[Manual reference]</b><br><br>Manual speed input. The parameter can be accessed if <b>[Auto/Manual assign.]</b> (PAU) is not <b>[No]</b> (nO).<br><input type="checkbox"/> <b>[No]</b> (nO): Not assigned (function inactive)<br><input type="checkbox"/> <b>[AI1]</b> (AI1): Analog input<br><input type="checkbox"/> <b>[AI2]</b> (AI2): Analog input<br><input type="checkbox"/> <b>[AI3]</b> (AI3): Analog input, if VW3A3202 extension card has been inserted<br><input type="checkbox"/> <b>[AI4]</b> (AI4): Analog input, if VW3A3202 extension card has been inserted<br><input type="checkbox"/> <b>[RP]</b> (PI): Frequency input, if VW3A3202 extension card has been inserted<br><input type="checkbox"/> <b>[Encoder]</b> (PG): Encoder input, if encoder card has been inserted<br>The preset speeds are active on the manual reference if they have been configured.  |                    | [No] (nO)       |



(1) The parameter can also be accessed in the **[1.3 SETTINGS]** (SEt-) menu.

(2) If a graphic display terminal is not in use, values greater than 9999 will be displayed on the 4-digit display with a period mark after the thousand digit,  
 e.g., 15.65 for 15650.

(3) Range 0.01 to 99.99 s or 0.1 to 999.9 s or 1 to 6000 s according to **[Ramp increment]** (Inr) page 134.

 Parameter that can be modified during operation or when stopped.

## [1.7 APPLICATION FUNCT.] (FUn-)



| Code  | Name/Description  | Adjustment range | Factory setting |
|---|---|------------------|-----------------|
| <b>■ [PID REGULATOR]</b> (continued)  |   |                  |                 |
| <span style="color: red;">tLS</span><br><br> | <input type="checkbox"/> <b>[Low speed time out]</b> (1) <p>Maximum operating time at [Low speed] (LSP) (see page 42)<br/>                     Following operation at LSP for a defined period, a motor stop is requested automatically. The motor restarts if the reference is greater than LSP and if a run command is still present.<br/>                     Caution: Value 0 corresponds to an unlimited period.</p> <p> <b>Note:</b> If [Low speed time out] (tLS) is not 0, [Type of stop] (Stt) page 137 is forced to [Ramp stop] (rMP) (only if a ramp stop can be configured).</p>   | 0 to 999.9 s     | 0 s             |
| <span style="color: red;">rSL</span>  | <input type="checkbox"/> <b>[PID wake up thresh.]</b> <p>If the "PID" and "Low speed operating time" tLS functions are configured at the same time, the PID regulator may attempt to set a speed lower than LSP.<br/>                     This results in unsatisfactory operation, which consists of starting, operating at low speed then stopping, and so on...<br/>                     Parameter rSL (restart error threshold) can be used to set a minimum PID error threshold for restarting after a stop at prolonged LSP.<br/>                     The function is inactive if tLS = 0 or if rSL = 0.</p> <div style="border: 1px solid black; padding: 5px; text-align: center;">  <b>WARNING</b><br/> <b>UNINTENDED EQUIPMENT OPERATION</b><br/>                     Check that unintended restarts will not present any danger.<br/> <b>Failure to follow these instructions can result in death or serious injury.</b> </div> | 0.0 to 100.0     | 0               |

(1) The parameter can also be accessed in the [1.3 SETTINGS] (SEt-) menu.

 Parameter that can be modified during operation or when stopped.



# [1.7 APPLICATION FUNCT.] (FUn-)

| Code  | Name/Description  | Adjustment range | Factory setting |
|---|---|------------------|-----------------|
| <b>Pr 1-</b>  | <b>■ [PID PRESET REFERENCES]</b><br>Function can be accessed if [PID feedback ass.] (PIF) is assigned.  |                  |                 |
| <b>Pr 2</b><br><br>n0<br>LI1<br>-<br>-<br>-   | <input type="checkbox"/> <b>[2 preset PID ref.]</b><br><br><input type="checkbox"/> <b>[No] (n0)</b> : Function inactive<br><input type="checkbox"/> <b>[LI1] (LI1)</b><br>:<br>:<br><input type="checkbox"/> <b>[...] (...)</b> : See the assignment conditions on page 121.<br>If the assigned input or bit is at 0, the function is inactive.<br>If the assigned input or bit is at 1, the function is active.   |                  | [No] (n0)       |
| <b>Pr 4</b><br><br>n0<br>LI1<br>-<br>-<br>-   | <input type="checkbox"/> <b>[4 preset PID ref.]</b><br><br>Make sure that [2 preset PID ref.] (Pr2) has been assigned before assigning this function.<br><input type="checkbox"/> <b>[No] (n0)</b> : Function inactive<br><input type="checkbox"/> <b>[LI1] (LI1)</b><br>:<br>:<br><input type="checkbox"/> <b>[...] (...)</b> : See the assignment conditions on page 121.<br>If the assigned input or bit is at 0, the function is inactive.<br>If the assigned input or bit is at 1, the function is active. |                  | [No] (n0)       |
| <b>rP2</b><br>  | <input type="checkbox"/> <b>[2 preset PID ref.]</b> (1)<br><br>The parameter can be accessed if [Preset ref. PID 2] (Pr2) is assigned.<br>Adjustment range from [Min PID reference] (PIP1) to [Max PID reference] (PIP2) (2).   |                  | 300             |
| <b>rP3</b><br> | <input type="checkbox"/> <b>[3 preset PID ref.]</b> (1)<br><br>The parameter can be accessed if [Preset ref. PID 4] (Pr4) is assigned.<br>Adjustment range from [Min PID reference] (PIP1) to [Max PID reference] (PIP2) (2).   |                  | 600             |
| <b>rP4</b><br> | <input type="checkbox"/> <b>[4 preset PID ref.]</b> (1)<br><br>The parameter can be accessed if [Preset ref. PID 4] (Pr4) is assigned.<br>Adjustment range from [Min PID reference] (PIP1) to [Max PID reference] (PIP2) (2).   |                  | 900             |

(1) The parameter can also be accessed in the [1.3 SETTINGS] (SEt-) menu.

(2) If a graphic display terminal is not in use, values greater than 9999 will be displayed on the 4-digit display with a period mark after the thousand digit, e.g., 15.65 for 15650.

 Parameter that can be modified during operation or when stopped.

## Torque regulation

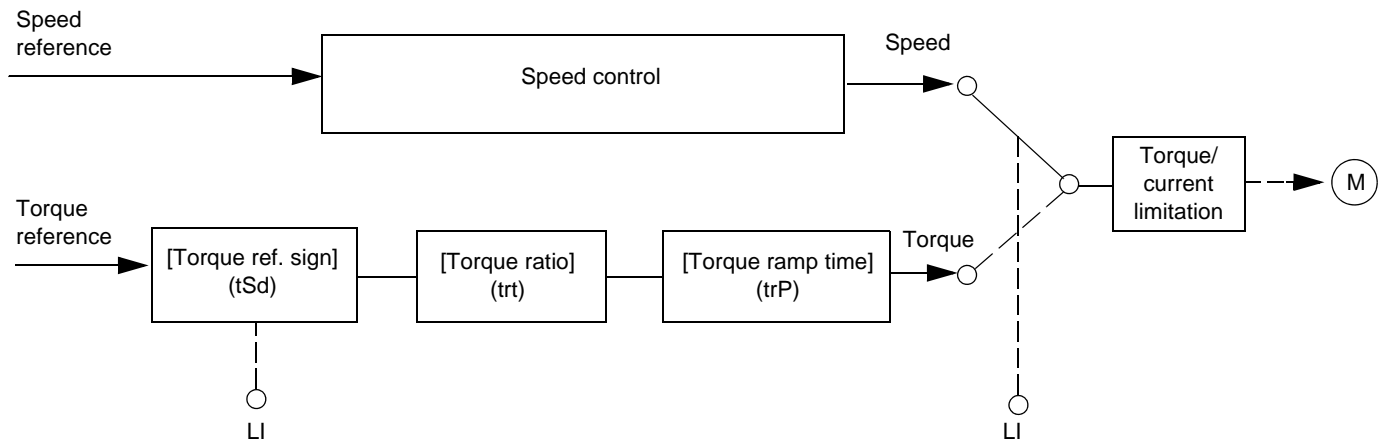

The function can be used to switch between operation in speed regulation mode and operation in torque control mode. In torque control mode, the speed may vary within a configurable "deadband". When it reaches a lower or upper limit, the drive automatically reverts to speed regulation mode (fallback) and remains at this limit speed. The regulated torque is therefore no longer maintained and two scenarios may occur.

- If the torque returns to the required value, the drive will return to torque control mode.
- If the torque does not return to the required value at the end of a configurable period of time, the drive will switch to fault or alarm mode.



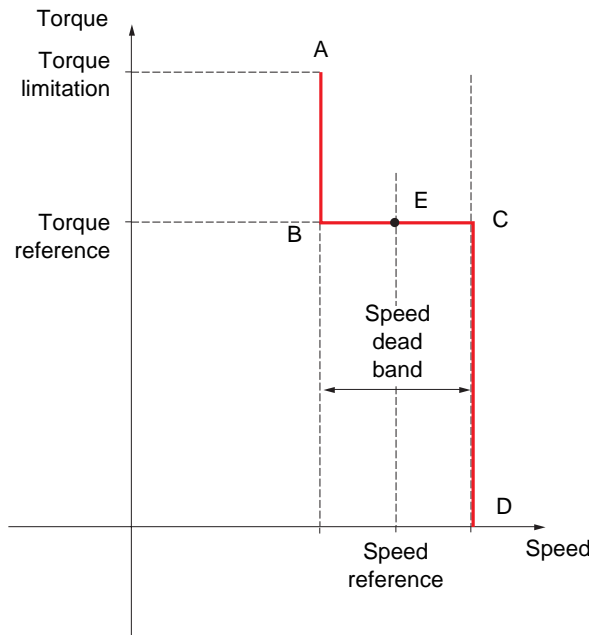

|  |
|--|
| ▲ WARNING  |
| UNINTENDED EQUIPMENT OPERATION   |
| Check that the changes in the behavior of the motor do not present any danger.<br><b>Failure to follow these instructions can result in death or serious injury.</b> |



- AB and CD: "Fallback" to speed regulation
- BC: Torque control zone
- E: Ideal operating point



The torque sign and value can be transmitted via a logic output and an analog output.

# [1.7 APPLICATION FUNCT.] (FUn-)

| Code  | Name/Description   | Adjustment range | Factory setting |
|---|--|------------------|-----------------|
| <b>↳ Dr -</b>   | <h2>■ [TORQUE CONTROL]</h2> <p>This function can only be accessed for [Motor control type] (Ctt) = [SVC I] (CUC) or [FVC] (FUC).</p> <p> <b>Note:</b> This function cannot be used with certain other functions. Follow the instructions on page 127.</p>   |                  |                 |
| <b>↳ SS</b><br>n0<br>YES<br>L11<br>-<br>-<br>-  | <input type="checkbox"/> <b>[Trq/spd switching]</b> <ul style="list-style-type: none"> <li><input type="checkbox"/> <b>[No] (nO)</b>: Function inactive, thereby preventing access to other parameters.</li> <li><input type="checkbox"/> <b>[Yes] (YES)</b>: Permanent torque control</li> <li><input type="checkbox"/> <b>[LI1] (LI1)</b></li> <li style="text-align: center;">⋮</li> <li><input type="checkbox"/> <b>[...] (...)</b>: See the assignment conditions on page 121.<br/>If the assigned input or bit is at 1: Torque control<br/>If the assigned input or bit is at 0: Speed regulation</li> </ul>   |                  | [No] (nO)       |
| <b>↳ r l</b><br>n0<br>A11<br>A12<br>A13<br>A14<br>LCC<br>Modb<br>CAN<br>nEt<br>APP<br>PI<br>PG      | <input type="checkbox"/> <b>[Torque ref. channel]</b> <ul style="list-style-type: none"> <li><input type="checkbox"/> <b>[No] (nO)</b>: Not assigned (zero torque reference).</li> <li><input type="checkbox"/> <b>[AI1] (AI1)</b>: Analog input</li> <li><input type="checkbox"/> <b>[AI2] (AI2)</b>: Analog input</li> <li><input type="checkbox"/> <b>[AI3] (AI3)</b>: Analog input, if VW3A3202 I/O card has been inserted</li> <li><input type="checkbox"/> <b>[AI4] (AI4)</b>: Analog input, if VW3A3202 I/O card has been inserted</li> <li><input type="checkbox"/> <b>[HMI] (LCC)</b>: Graphic display terminal</li> <li><input type="checkbox"/> <b>[Modbus] (Mdb)</b>: Integrated Modbus</li> <li><input type="checkbox"/> <b>[CANopen] (CAN)</b>: Integrated CANopen</li> <li><input type="checkbox"/> <b>[Com. card] (nEt)</b>: Communication card (if inserted)</li> <li><input type="checkbox"/> <b>[C.Insid. card] (APP)</b>: Controller Inside card (if inserted)</li> <li><input type="checkbox"/> <b>[RP] (PI)</b>: Frequency input, if VW3A3202 I/O card has been inserted</li> <li><input type="checkbox"/> <b>[Encoder] (PG)</b>: Encoder input, if encoder card has been inserted<br/>100% of the reference corresponds to 300% of the rated torque.</li> </ul> |                  | [No] (nO)       |
| <b>↳ Sd</b><br>n0<br>L11<br>-<br>-<br>-   | <input type="checkbox"/> <b>[Torque ref. sign]</b> <ul style="list-style-type: none"> <li><input type="checkbox"/> <b>[No] (nO)</b>: Function inactive</li> <li><input type="checkbox"/> <b>[LI1] (LI1)</b></li> <li style="text-align: center;">⋮</li> <li><input type="checkbox"/> <b>[...] (...)</b>: See the assignment conditions on page 121.<br/>If the assigned input or bit is at 0, the torque sign is the same as the reference.<br/>If the assigned input or bit is at 1, the torque sign is the opposite of the reference.</li> </ul>   |                  | [No] (nO)       |
| <b>↳ r t</b><br> | <input type="checkbox"/> <b>[Torque ratio]</b><br>Coefficient applied to [Torque reference] (tr1).   | 0 to 1000%       | 100%            |
| <b>↳ r P</b><br> | <input type="checkbox"/> <b>[Torque ramp time]</b><br>Rise and fall time for a variation of 100% of the rated torque.  | 0 to 99.99 s     | 3 s             |
| <b>↳ St</b><br>SPd<br>YES<br>SPn  | <input type="checkbox"/> <b>[Torque control stop]</b> <ul style="list-style-type: none"> <li><input type="checkbox"/> <b>[Speed] (SPd)</b>: Speed regulation stop, in accordance with the type of stop configuration (see page 137)</li> <li><input type="checkbox"/> <b>[Freewheel] (YES)</b>: Freewheel stop</li> <li><input type="checkbox"/> <b>[Spin] (SPn)</b>: Zero torque stop, but maintaining the flux in the motor. This type of operation is only possible if [Motor control type] (Ctt) = [FVC] (FUC).</li> </ul>   |                  | [Speed] (SPd)   |
| <b>↳ Pt</b><br>  | <input type="checkbox"/> <b>[Spin time]</b><br>The parameter can be accessed if [Torque control stop] (tSt) = [Spin] (SPn)<br>Spin time following stop, in order to remain ready to restart quickly.   | 0 to 3600 s      | 1               |

 Parameter that can be modified during operation or when stopped.

## [1.7 APPLICATION FUNCT.] (FUn-)

| Code  | Name/Description  | Adjustment range               | Factory setting |
|---|---|--------------------------------|-----------------|
| <b>■ [TORQUE CONTROL] (continued)</b>   |   |                                |                 |
| <i>dbP</i><br> | <input type="checkbox"/> <b>[Positive deadband]</b><br><br>Positive deadband.<br>Value added algebraically to the speed reference.<br>Example for dbP = 10:<br><ul style="list-style-type: none"> <li>• If reference = +50 Hz: + 50 + 10 = 60</li> <li>• If reference = - 50 Hz: - 50 + 10 = - 40</li> </ul>        | 0 to 2 x [Max frequency] (tFr) | 10 Hz           |
| <i>dbn</i><br> | <input type="checkbox"/> <b>[Negative deadband]</b><br><br>Negative deadband.<br>Value subtracted algebraically from the speed reference.<br>Example for dbn = 10:<br><ul style="list-style-type: none"> <li>• If reference = +50 Hz: + 50 - 10 = 40</li> <li>• If reference = - 50 Hz: - 50 - 10 = - 60</li> </ul> | 0 to 2 x [Max frequency] (tFr) | 10 Hz           |
| <i>rtO</i>  | <input type="checkbox"/> <b>[Torque ctrl time out]</b><br><br>Time following automatic exit of torque control mode in the event of a fault or alarm.  | 0 to 999.9 s                   | 60              |
| <i>tOb</i>  | <input type="checkbox"/> <b>[Torq. ctrl fault mgt]</b><br>Response of drive once time [Torque ctrl time out] (rtO) has elapsed.   |                                | [Alarm] (ALrM)  |
| <i>ALrM</i><br><i>FLt</i>   | <input type="checkbox"/> <b>[Alarm] (ALrM)</b><br><input type="checkbox"/> <b>[Fault] (FLt)</b> : Fault with freewheel stop.  |                                |                 |

 Parameter that can be modified during operation or when stopped.

## Torque limitation

There are two types of torque limitation:

- With a value that is fixed by a parameter
- With a value that is set by an analog input (AI, pulse or encoder)

If both types are enabled, the lowest value is taken into account. The two types of limitation can be configured or switched remotely using a logic input or via the communication bus.

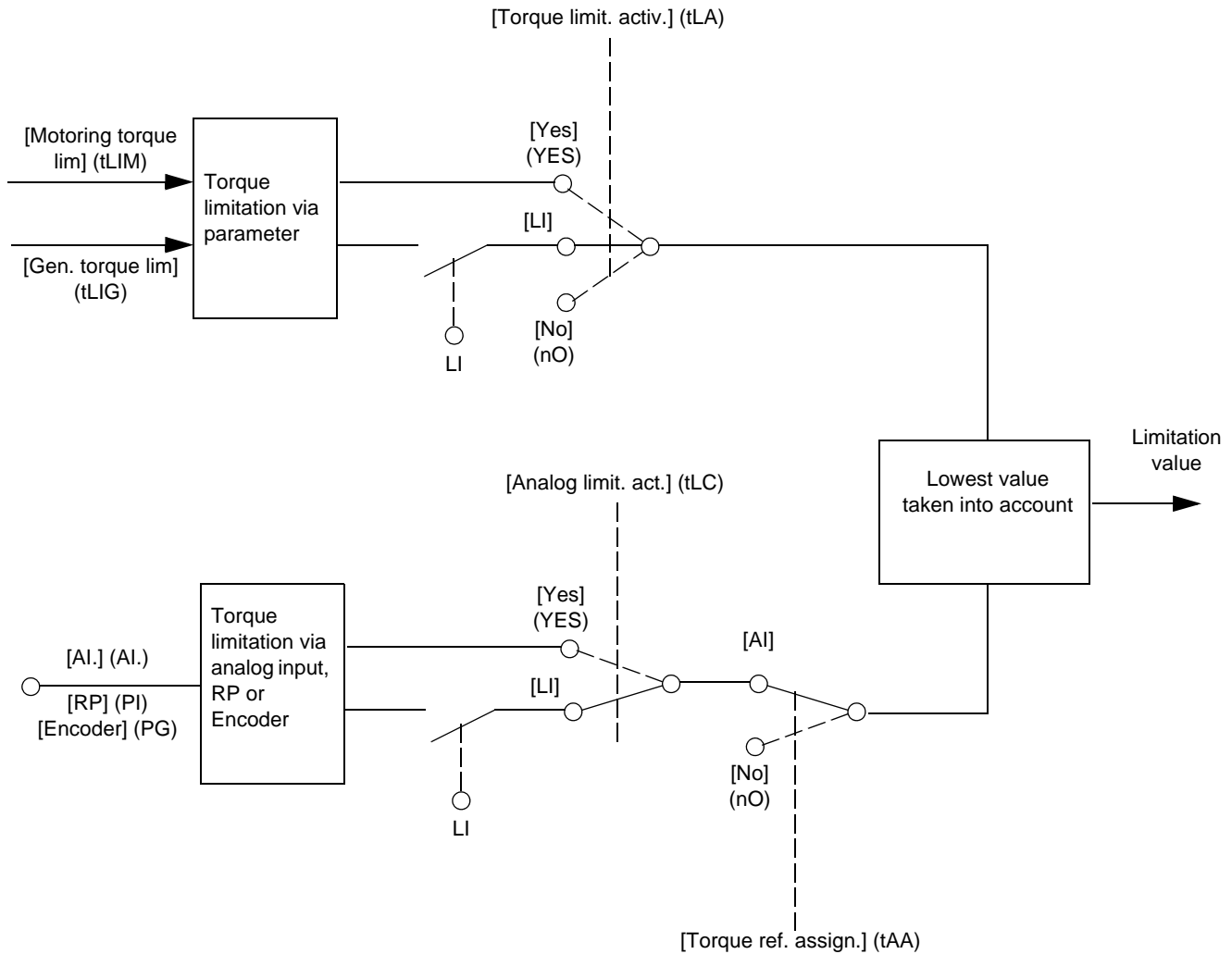

# [1.7 APPLICATION FUNCT.] (FUn-)

| Code  | Name/Description   | Adjustment range | Factory setting |
|---|--|------------------|-----------------|
| <b>EDL -</b>  | <b>[TORQUE LIMITATION]</b><br>This function cannot be accessed in V/F profile mode.  |                  |                 |
| <b>ELR</b><br>nO<br>YES<br>L I I<br>-<br>-<br>-   | <input type="checkbox"/> <b>[Torque limit. activ.]</b><br><input type="checkbox"/> <b>[No] (nO)</b> : Function inactive<br><input type="checkbox"/> <b>[Yes] (YES)</b> : Function always active<br><input type="checkbox"/> <b>[LI1] (LI1)</b><br>:<br>:<br><input type="checkbox"/> <b>[...] (...)</b> : See the assignment conditions on page 121.<br>If the assigned input or bit is at 0, the function is inactive.<br>If the assigned input or bit is at 1, the function is active.   |                  | [No] (nO)       |
| <b>IntP</b><br>D. I<br>I  | <input type="checkbox"/> <b>[Torque increment]</b><br>The parameter cannot be accessed if <b>[Torque limit. activ.] (tLA) = [No] (nO)</b><br>Selection of units for the <b>[Motoring torque lim] (tLIM)</b> and <b>[Gen. torque lim] (tLIG)</b> parameters.<br><input type="checkbox"/> <b>[0,1%] (0.1)</b> : unit 0.1%.<br><input type="checkbox"/> <b>[1%] (1)</b> : unit 1%.  |                  | [1 %] (1)       |
| <b>ELIN</b><br>(C)  | <input type="checkbox"/> <b>[Motoring torque lim]</b> (1)<br>The parameter cannot be accessed if <b>[Torque limit. activ.] (tLA) = [No] (nO)</b><br>Torque limitation in motor mode, as a % or in 0.1% increments of the rated torque in accordance with the <b>[Torque increment] (IntP)</b> parameter.   | 0 to 300%        | 100%            |
| <b>ELIG</b><br>(C)  | <input type="checkbox"/> <b>[Gen. torque lim]</b> (1)<br>The parameter cannot be accessed if <b>[Torque limit. activ.] (tLA) = [No] (nO)</b><br>Torque limitation in generator mode, as a % or in 0.1% increments of the rated torque in accordance with the <b>[Torque increment] (IntP)</b> parameter.   | 0 to 300%        | 100%            |
| <b>ELR</b><br>nO<br>A I I<br>-<br>A I 4<br>P I<br>P G<br>A I U I  | <input type="checkbox"/> <b>[Torque ref. assign.]</b><br>If the function is assigned, the limitation varies between 0% and 300% of the rated torque on the basis of the 0% to 100% signal applied to the assigned input.<br>Examples:<br>- 12 mA on a 4-20 mA input results in limitation to 150% of the rated torque.<br>- 2.5 V on a 10 V input results in 75% of the rated torque.<br><input type="checkbox"/> <b>[No] (nO)</b> : Not assigned (function inactive)<br><input type="checkbox"/> <b>[AI1] (AI1)</b><br>to<br><input type="checkbox"/> <b>[AI4] (AI4)</b> : Analog input, if VW3A3202 I/O card has been inserted<br><input type="checkbox"/> <b>[RP] (PI)</b> : Frequency input, if VW3A3202 I/O card has been inserted<br><input type="checkbox"/> <b>[Encoder] (PG)</b> : Encoder input, if encoder card has been inserted<br><input type="checkbox"/> <b>[Network AI] (AIU1)</b> : Virtual input via communication bus, to be configured via <b>[AI net. channel] (AIC1)</b> page 95. |                  | [No] (nO)       |
|  <b>WARNING</b>  |  |                  |                 |
| <b>UNINTENDED EQUIPMENT OPERATION</b><br>If the equipment switches to forced local mode (see page 237), the virtual input remains fixed at the last value transmitted.<br>Do not use the virtual input and forced local mode in the same configuration.<br><b>Failure to follow these instructions can result in death or serious injury.</b> |  |                  |                 |

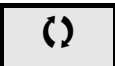

(1) The parameter can also be accessed in the [1.3 SETTINGS] (SEt-) menu.

 Parameter that can be modified during operation or when stopped.

## [1.7 APPLICATION FUNCT.] (FUn-)

| Code                                       | Name/Description  | Adjustment range | Factory setting  |
|--|---|------------------|--|
|  | <div style="background-color: #00FFFF; padding: 5px;"> <b>■ [TORQUE LIMITATION]</b> (continued)         </div>  |                  |  |
| E L C<br><br>Y E S<br>L I I<br>-<br>-<br>- | <div style="background-color: #FFFF00; padding: 5px;"> <input type="checkbox"/> <b>[Analog limit. act.]</b> </div> <p>The parameter can be accessed if [Torque ref. assign.] (tAA) is not [No] (nO).</p> <div style="background-color: #FFFF00; padding: 5px;"> <input type="checkbox"/> <b>[Yes] (YES):</b> The limitation depends on the input assigned by [Torque ref. assign.] (tAA).           </div> <div style="background-color: #FFFF00; padding: 5px;"> <input type="checkbox"/> <b>[LI1] (LI1)</b><br/>             :<br/>             :<br/>             :           </div> <div style="background-color: #FFFF00; padding: 5px;"> <input type="checkbox"/> <b>[...] (...):</b> See the assignment conditions on page <a href="#">121</a>.<br/>             If the assigned input or bit is at 0:             <ul style="list-style-type: none"> <li>• The limitation is specified by the [Motoring torque lim] (tLIM) and [Gen. torque lim.] parameters (tLIG) if [Torque limit. activ.] (tLA) is not [No] (nO).</li> <li>• No limitation if [Torque limit. activ.] (tLA) = [No] (nO).</li> </ul>             If the assigned input or bit is at 1:             <ul style="list-style-type: none"> <li>• The limitation depends on the input assigned by [Torque ref. assign.] (tAA).</li> </ul> <b>Note:</b> If [Torque limitation] (tLA) and [Torque ref. assign.] (tAA) are enabled at the same time, the lowest value will be taken into account.           </div> |                  | <div style="background-color: #FFFF00; padding: 5px; border: 1px solid black;">             [Yes] (YES)           </div> |

## [1.7 APPLICATION FUNCT.] (FUn-)

| Code                                   | Name/Description  | Adjustment range | Factory setting |
|--|---|------------------|-----------------|
| <b>CL1-</b>                            | <b>■ [2nd CURRENT LIMIT.]</b>   |                  |                 |
| <b>LC2</b><br>n0<br>LI1<br>-<br>-<br>- | <input type="checkbox"/> <b>[Current limit 2]</b><br><input type="checkbox"/> <b>[No] (n0)</b> : Function inactive.<br><input type="checkbox"/> <b>[LI1] (LI1)</b><br>...<br><input type="checkbox"/> <b>[...] (...)</b> : See the assignment conditions on page 121.<br>If the assigned input or bit is at 0, the first current limitation is active.<br>If the assigned input or bit is at 1, the second current limitation is active.  |                  | [No] (n0)       |
| <b>CL2</b><br>( )                      | <input type="checkbox"/> <b>[I Limit. 2 value]</b> (1)<br>Second current limitation The parameter can be accessed if <b>[Current limit 2] (LC2)</b> is not <b>[No] (n0)</b> . The adjustment range is limited to 1.36 In if <b>[Switching freq.] (SFr)</b> page 59 is less than 2 kHz.<br> <b>Note:</b> If the setting is less than 0.25 In, the drive may lock in <b>[Output Phase Loss] (OPF)</b> fault mode if this has been enabled (see page 217). If it is less than the no-load motor current, the limitation no longer has any effect. | 0 to 1.65 In (2) | 1.5 In (2)      |
| <b>CL1</b><br>( )                      | <input type="checkbox"/> <b>[Current Limitation]</b> (1)<br>First current limitation<br>The adjustment range is limited to 1.36 In if <b>[Switching freq.] (SFr)</b> page 59 is less than 2 kHz.<br> <b>Note:</b> If the setting is less than 0.25 In, the drive may lock in <b>[Output Phase Loss] (OPF)</b> fault mode if this has been enabled (see page 217). If it is less than the no-load motor current, the limitation no longer has any effect.   | 0 to 1.65 In (2) | 1.5 In (2)      |

(1) The parameter can also be accessed in the **[1.3 SETTINGS] (SEt-)** menu.

(2) In corresponds to the rated drive current indicated in the Installation Manual and on the drive nameplate.

 Parameter that can be modified during operation or when stopped.



## [1.7 APPLICATION FUNCT.] (FUn-)

### Line contactor command

The line contactor closes every time a run command (forward or reverse) is sent and opens after every stop, as soon as the drive is locked. For example, if the stop mode is stop on ramp, the contactor will open when the motor reaches zero speed.

 **Note:** The drive control power supply must be provided via an external 24 V source.

Example circuit:

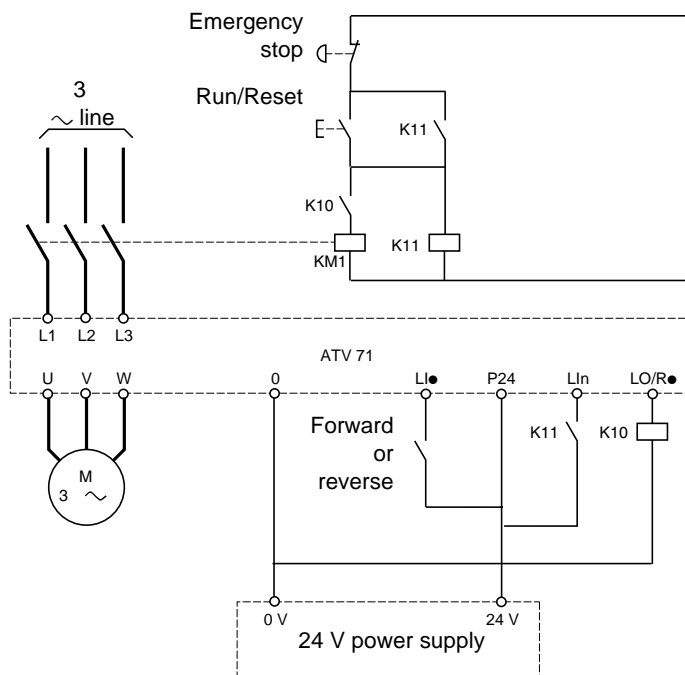

**Note:** The "Run/Reset" button must be pressed once the "Emergency stop" button has been released.

Li● = Run command [Forward] or [Reverse]  
LO/R● □ [Line contactor ass.] (LLC)  
Lin = [Drive lock] (LES)

### CAUTION

This function can only be used for a small number of consecutive operations with a cycle time longer than 60 s (in order to avoid premature aging of the filter capacitor charging circuit).

Failure to follow this instruction can result in equipment damage.

## [1.7 APPLICATION FUNCT.] (FUn-)

| Code         | Name/Description  | Adjustment range | Factory setting |
|--------------|---|------------------|-----------------|
| <b>LLC -</b> | <b>■ [LINE CONTACTOR COMMAND]</b>   |                  |                 |
| <b>LLC</b>   | <input type="checkbox"/> <b>[Line contactor ass.]</b>   |                  | [No] (nO)       |
| n0           | Logic output or control relay   |                  |                 |
| LO1          | <input type="checkbox"/> [No] (nO): Function not assigned (in this case, none of the function parameters can be accessed).  |                  |                 |
| -            | <input type="checkbox"/> [LO1] (LO1)  |                  |                 |
| LO4          | to  |                  |                 |
| r2           | [LO4] (LO4): Logic output (if one or two I/O cards have been inserted, LO1 to LO2 or LO4 can be selected).  |                  |                 |
| -            | <input type="checkbox"/> [R2] (r2)  |                  |                 |
| r4           | to  |                  |                 |
| dO1          | [R4] (r4): Relay (selection of R2 extended to R3 or R4 if one or two I/O cards have been inserted).   |                  |                 |
|              | <input type="checkbox"/> [dO1] (dO1): Analog output AO1 functioning as a logic output. Selection can be made if [AO1 assignment] (AO1) page 108 = [No] (nO).                            |                  |                 |
| <b>LES</b>   | <input type="checkbox"/> <b>[Drive lock]</b>  |                  | [No] (nO)       |
| n0           | <input type="checkbox"/> [No] (nO): Function inactive.  |                  |                 |
| LI1          | <input type="checkbox"/> [LI1] (LI1)  |                  |                 |
| -            | ⋮   |                  |                 |
| -            | <input type="checkbox"/> [...] (...): See the assignment conditions on page 121.  |                  |                 |
| -            | The drive locks when the assigned input or bit changes to 0.  |                  |                 |
| <b>LCt</b>   | <input type="checkbox"/> <b>[Mains V. time out]</b>   | 5 to 999 s       | 5 s             |
|              | Monitoring time for closing of line contactor. If, once this time has elapsed, there is no voltage on the drive power circuit, the drive will lock with a "Line contactor" fault (LCF). |                  |                 |

## [1.7 APPLICATION FUNCT.] (FUn-)

### Output contactor command

This allows the drive to control a contactor located between the drive and the motor. The request for the contactor to close is made when a run command is sent. The request for the contactor to open is made when there is no longer any current in the motor.

#### CAUTION

If a DC injection braking function has been configured it should not be left operating too long in stop mode, as the contactor only opens at the end of braking.

**Failure to follow this instruction can result in equipment damage.**

### Output contactor feedback

The corresponding logic input should be at 1 when there is no run command and at 0 during operation.

In the event of an inconsistency, the drive trips on an FCF2 fault if the output contactor fails to close (Llx at 1) and on an FCF1 fault if it is stuck (Llx at 0).

The parameter [\[Delay to motor run\] \(dbS\)](#) can be used to delay tripping in fault mode when a run command is sent and the [\[Delay to open cont.\] \(dAS\)](#) parameter delays the fault when a stop command is set.

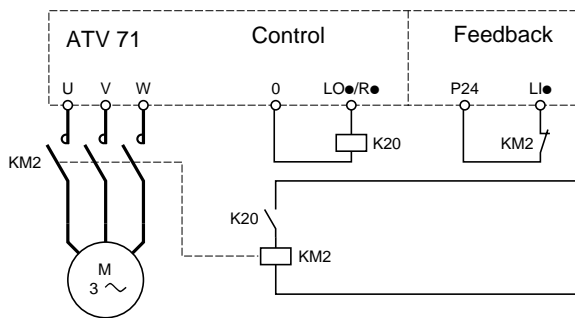

#### Note:

Fault FCF2 (contactor failing to close) can be reset by the run command changing state from 1 to 0 (0 --> 1 --> 0 in 3-wire control).



The [\[Out. contactor ass.\] \(OCC\)](#) and [\[Output contact. fdbk\] \(rCA\)](#) functions can be used individually or together.

## [1.7 APPLICATION FUNCT.] (FUn-)

| Code  | Name/Description  | Adjustment range | Factory setting  |
|---|---|------------------|------------------|
| <b>OCC -</b>  | <b>■ [OUTPUT CONTACTOR CMD]</b>   |                  |                  |
| <b>OCC</b><br>n0<br>LO1<br>-<br>LO4<br>r2<br>-<br>r4<br>d01                                       | <input type="checkbox"/> <b>[Out. contactor ass.]</b><br>Logic output or control relay<br><input type="checkbox"/> <b>[No]</b> (nO): Function not assigned (in this case, none of the function parameters can be accessed).<br><input type="checkbox"/> <b>[LO1]</b> (LO1)<br>to<br><b>[LO4]</b> (LO4): Logic output (if one or two I/O cards have been inserted, LO1 to LO2 or LO4 can be selected).<br><input type="checkbox"/> <b>[R2]</b> (r2)<br>to<br><b>[R4]</b> (r4): Relay (selection of R2 extended to R3 or R4 if one or two I/O cards have been inserted).<br><input type="checkbox"/> <b>[dO1]</b> (dO1): Analog output AO1 functioning as a logic output. Selection can be made if <b>[AO1 assignment]</b> (AO1) page 108 = <b>[No]</b> (nO). |                  | <b>[No]</b> (nO) |
| <b>rCA</b><br>n0<br>LI1<br>-<br>-<br>-  | <input type="checkbox"/> <b>[Output contact. fdbk]</b><br><input type="checkbox"/> <b>[No]</b> (nO): Function inactive<br><input type="checkbox"/> <b>[LI1]</b> (LI1)<br>:<br>:<br><input type="checkbox"/> <b>[...]</b> (...): See the assignment conditions on page 121.<br>The motor starts up when the assigned input or bit changes to 0.  |                  | <b>[No]</b> (nO) |
| <b>db5</b><br>  | <input type="checkbox"/> <b>[Delay to motor run]</b><br>Time delay for: <ul style="list-style-type: none"> <li>• Motor control following the sending of a run command</li> <li>• Output contactor fault monitoring, if the feedback is assigned. If the contactor fails to close at the end of the set time, the drive will lock in FCF2 fault mode.</li> </ul> This parameter can be accessed if <b>[Output cont.]</b> (OCC) is assigned or if <b>[Output contact. fdbk]</b> (rCA) is assigned.<br>The time delay must be greater than the closing time of the output contactor.   | 0.05 to 60 s     | 0.15             |
| <b>dAS</b><br> | <input type="checkbox"/> <b>[Delay to open cont.]</b><br>Time delay for output contactor opening command following motor stop.<br>This parameter can be accessed if <b>[Output contact. fdbk]</b> (rCA) is assigned.<br>The time delay must be greater than the opening time of the output contactor. If it is set to 0, the fault will not be monitored.<br>If the contactor fails to open at the end of the set time, the drive will lock in FCF1 fault mode.   | 0 to 5.00 s      | 0.10             |

 Parameter that can be modified during operation or when stopped.

## [1.7 APPLICATION FUNCT.] (FUn-)

### Positioning by sensors or limit switches

This function is used for managing positioning using position sensors or limit switches linked to logic inputs or using control word bits:

- Slowing down
- Stopping

The action logic for the inputs and bits can be configured on a rising edge (change from 0 to 1) or a falling edge (change from 1 to 0). The example below has been configured on a rising edge:

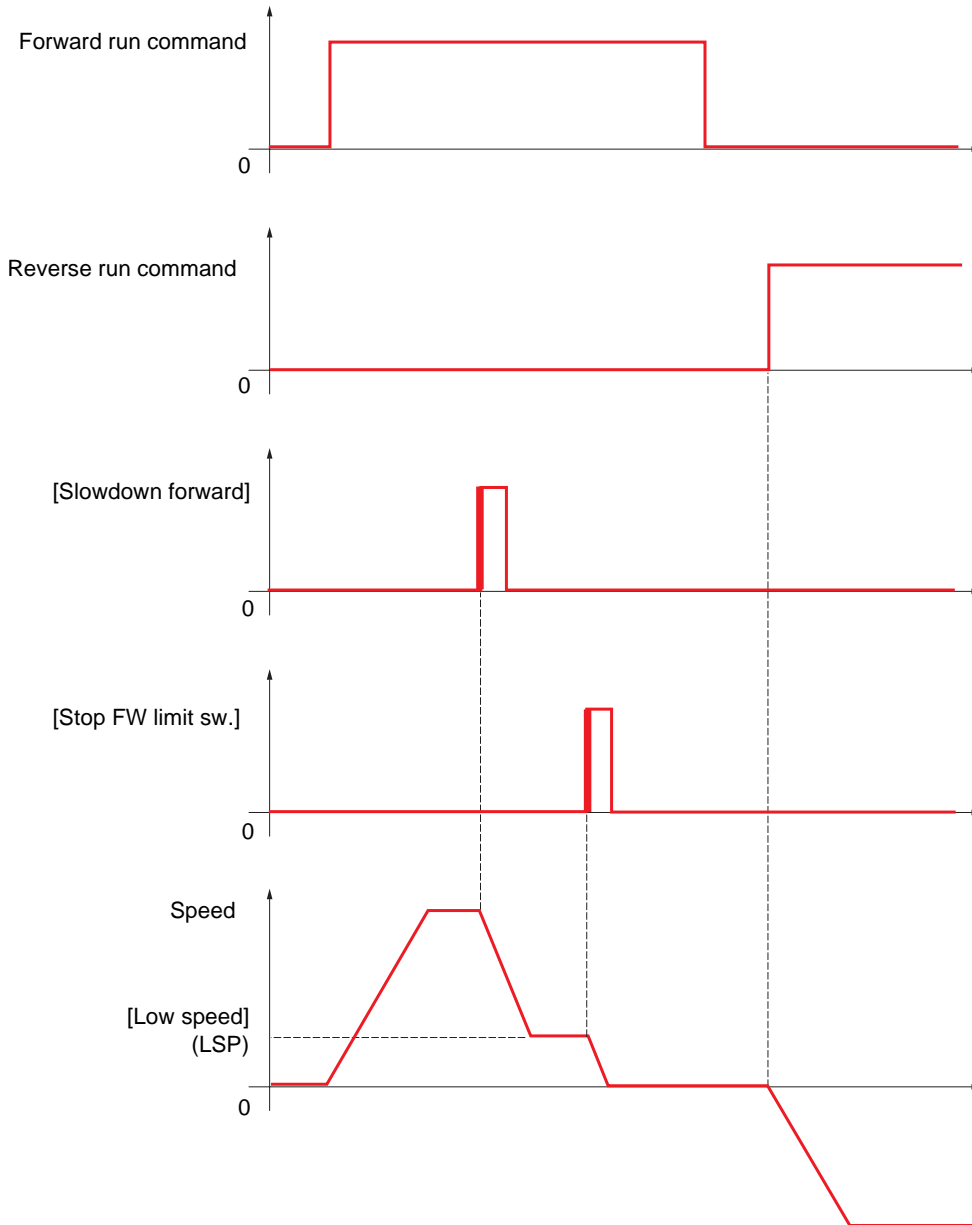

The slowdown mode and stop mode can be configured.

The operation is identical for both directions of operation. Slowdown and stopping operate according to the same logic, described below.

#### Example: Forward slowdown, on rising edge

- Forward slowdown takes place on a rising edge (change from 0 to 1) of the input or bit assigned to forward slowdown if this rising edge occurs in forward operation. The slowdown command is then memorized, even in the event of a power outage. Operation in the opposite direction is authorized at high speed. The slowdown command is deleted on a falling edge (change from 1 to 0) of the input or bit assigned to forward slowdown if this falling edge occurs in reverse operation.
- A bit or a logic input can be assigned to disable this function.
- Although forward slowdown is disabled while the disable input or bit is at 1, sensor changes continue to be monitored and saved.

## [1.7 APPLICATION FUNCT.] (FUn-)

### Example: Positioning on a limit switch, on rising edge

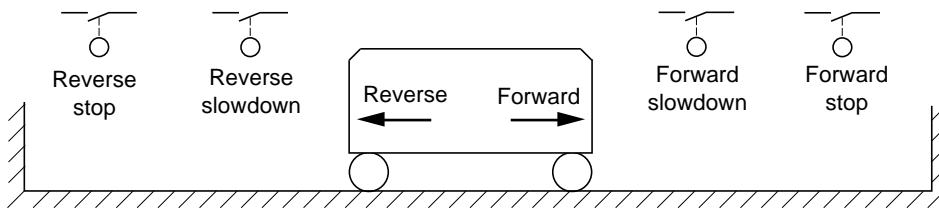

### Operation with short cams:

In this instance, when operating for the first time or after restoring the factory settings, the drive must initially be started outside the slowdown and stop zones in order to initialize the function.

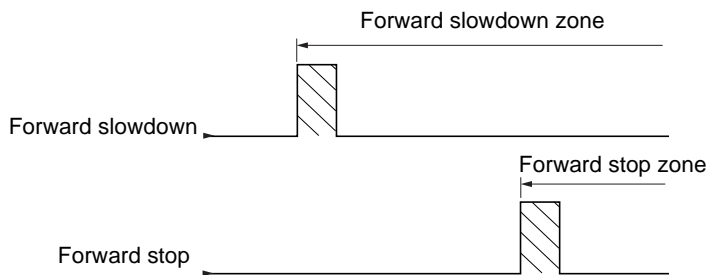

### Operation with long cams:

In this instance, there is no restriction, which means that the function is initialized across the whole trajectory.

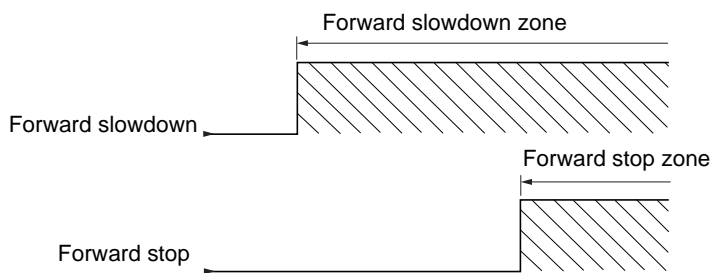

## [1.7 APPLICATION FUNCT.] (FUn-)

### Stop at distance calculated after deceleration limit switch

This function can be used to control the stopping of the moving part automatically once a preset distance has been traveled after the slowdown limit switch.

On the basis of the rated linear speed and the speed estimated by the drive when the slowdown limit switch is tripped, the drive will induce the stop at the configured distance.

This function is useful in applications where one manual-reset overtravel limit switch is common to both directions. It will then only respond to ensure safety if the distance is exceeded. The stop limit switch retains priority in respect of the function.

The [Deceleration type] (dSF) parameter can be configured to obtain either of the functions described below:

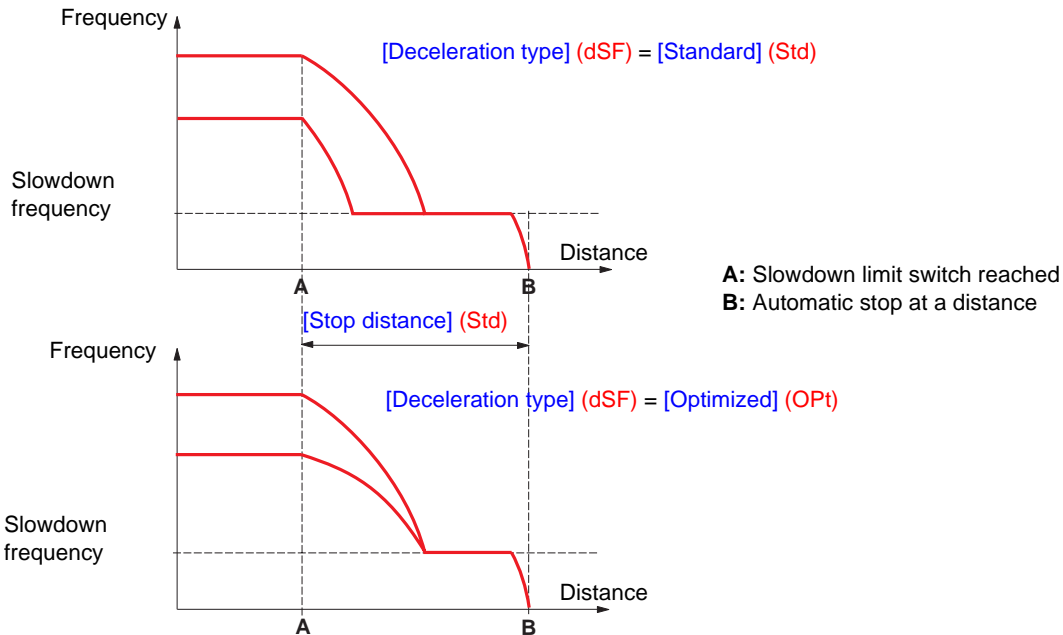

**Note :**

- If the deceleration ramp is modified while stopping at a distance is in progress, this distance will not be observed.
- If the direction is modified while stopping at a distance is in progress, this distance will not be observed.

### DANGER

#### UNINTENDED EQUIPMENT OPERATION

- Check that the parameters configured are consistent (in particular, you should check that the required distance is possible).
- This function does not replace the stop limit switch, which remains necessary for safety reasons.

**Failure to follow these instructions will result in death or serious injury.**

# [1.7 APPLICATION FUNCT.] (FUn-)

| Code   | Name/Description   | Adjustment range | Factory setting     |
|--|--|------------------|---------------------|
| <b>L P D -</b>   | <div style="background-color: #00b0f0; color: white; padding: 5px;"> <h2 style="margin: 0;">■ [POSITIONING BY SENSORS]</h2> <p style="margin: 0;"> <b>Note:</b> This function cannot be used with certain other functions. Follow the instructions on page <a href="#">127</a>.</p> </div>   |                  |                     |
| <b>S A F</b><br>n O<br>L I I<br>-<br>-<br>C I O I<br>-<br>-<br>-<br>C d O O<br>- | <input type="checkbox"/> <b>[Stop FW limit sw.]</b> <ul style="list-style-type: none"> <li><input type="checkbox"/> <b>[No]</b> (nO): Not assigned</li> <li><input type="checkbox"/> <b>[LI1]</b> (LI1) to <b>[LI6]</b> (LI6)</li> <li><input type="checkbox"/> <b>[LI7]</b> (LI7) to <b>[LI10]</b> (LI10): If VW3A3201 logic I/O card has been inserted</li> <li><input type="checkbox"/> <b>[LI11]</b> (LI11) to <b>[LI14]</b> (LI14): If VW3A3202 extended I/O card has been inserted</li> <li><input type="checkbox"/> <b>[C101]</b> (C101) to <b>[C115]</b> (C115): With integrated Modbus in [I/O profile] (IO)</li> <li><input type="checkbox"/> <b>[C201]</b> (C201) to <b>[C215]</b> (C215): With integrated CANopen in [I/O profile] (IO)</li> <li><input type="checkbox"/> <b>[C301]</b> (C301) to <b>[C315]</b> (C315): With a communication card in [I/O profile] (IO)</li> <li><input type="checkbox"/> <b>[C401]</b> (C401) to <b>[C415]</b> (C415): With a Controller Inside card in [I/O profile] (IO)</li> <li><input type="checkbox"/> <b>[CD00]</b> (Cd00) to <b>[CD13]</b> (Cd13): In [I/O profile] (IO) can be switched with possible logic inputs</li> <li><input type="checkbox"/> <b>[CD14]</b> (Cd14) to <b>[CD15]</b> (Cd15): In [I/O profile] (IO) can be switched without logic inputs</li> </ul> |                  | [No] (nO)           |
| <b>S A r</b>   | <input type="checkbox"/> <b>[Stop RV limit sw.]</b><br>Same assignments possible as for <b>[Stop FW limit sw.] (SAF)</b> above.  |                  | [No] (nO)           |
| <b>S A L</b><br>L O<br>H I G   | <input type="checkbox"/> <b>[Stop limit config.]</b><br>The parameter can be accessed if at least one limit switch or one stop sensor has been assigned. It defines the positive or negative logic of the bits or inputs assigned to the stop. <ul style="list-style-type: none"> <li><input type="checkbox"/> <b>[Active low]</b> (LO): Stop controlled on a falling edge (change from 1 to 0) of the assigned bits or inputs.</li> <li><input type="checkbox"/> <b>[Active high]</b> (HIG): Stop controlled on a rising edge (change from 0 to 1) of the assigned bits or inputs.</li> </ul>   |                  | [Active high] (HIG) |
| <b>d A F</b>   | <input type="checkbox"/> <b>[Slowdown forward]</b><br>Same assignments possible as for <b>[Stop FW limit sw.] (SAF)</b> above.   |                  | [No] (nO)           |
| <b>d A r</b>   | <input type="checkbox"/> <b>[Slowdown reverse]</b><br>Same assignments possible as for <b>[Stop FW limit sw.] (SAF)</b> above.   |                  | [No] (nO)           |
| <b>d A L</b><br>L O<br>H I G   | <input type="checkbox"/> <b>[Slowdown limit cfg.]</b><br>The parameter can be accessed if at least one limit switch or one slowdown sensor has been assigned. It defines the positive or negative logic of the bits or inputs assigned to the slowdown. <ul style="list-style-type: none"> <li><input type="checkbox"/> <b>[Active low]</b> (LO): Slowdown controlled on a falling edge (change from 1 to 0) of the assigned bits or inputs.</li> <li><input type="checkbox"/> <b>[Active high]</b> (HIG): Slowdown controlled on a rising edge (change from 0 to 1) of the assigned bits or inputs.</li> </ul>  |                  | [Active high] (HIG) |



## [1.7 APPLICATION FUNCT.] (FUn-)

| Code  | Name/Description  | Adjustment range | Factory setting   |
|---|---|------------------|-------------------|
| <b>■ [POSITIONING BY SENSORS]</b> (continued) |   |                  |                   |
| <i>CLS</i>                                    | <input type="checkbox"/> <b>[Disable limit sw.]</b><br>The parameter can be accessed if at least one limit switch or one sensor has been assigned.  |                  | [No] (nO)         |
| <i>nO</i><br><i>LI1</i><br>-<br>-<br>-        | <input type="checkbox"/> <b>[No]</b> (nO): Not assigned<br><input type="checkbox"/> <b>[LI1]</b> (LI1)<br>:<br>:<br><input type="checkbox"/> <b>[...]</b> (...): See the assignment conditions on page 121.<br>The action of the limit switches is disabled when the assigned bit or input is at 1. If, at this time, the drive is stopped or being slowed down by limit switches, it will restart up to its speed reference.                                   |                  |                   |
| <i>PAS</i>                                    | <input type="checkbox"/> <b>[Stop type]</b><br>The parameter can be accessed if at least one limit switch or one sensor has been assigned.  |                  | [Ramp stop] (rMP) |
| <i>rMP</i><br><i>FSt</i><br><i>YES</i>        | <input type="checkbox"/> <b>[Ramp stop]</b> (rMP): On ramp<br><input type="checkbox"/> <b>[Fast stop]</b> (FSt): Fast stop (ramp time reduced by [Ramp divider] (dCF), see page 137)<br><input type="checkbox"/> <b>[Freewheel]</b> (YES): Freewheel stop   |                  |                   |
| <i>dSF</i>                                    | <input type="checkbox"/> <b>[Deceleration type]</b><br>The parameter can be accessed if at least one limit switch or one sensor has been assigned.  |                  | [Standard] (Std)  |
| <i>Std</i><br><i>OPT</i>                      | <input type="checkbox"/> <b>[Standard]</b> (Std): Uses the [Deceleration] (dEC) or [Deceleration 2] (dE2) ramp (depending on which has been enabled).<br><input type="checkbox"/> <b>[Optimized]</b> (OPT): The ramp time is calculated on the basis of the actual speed when the slowdown contact switches, in order to limit the operating time at low speed (optimization of the cycle time: the slowdown time is constant regardless of the initial speed). |                  |                   |
| <i>Std</i>                                    | <input type="checkbox"/> <b>[Stop distance]</b><br>The parameter can be accessed if at least one limit switch or one sensor has been assigned.  |                  | [No] (nO)         |
| <i>nO</i><br>-                                | Activation and adjustment of the "Stop at distance calculated after the slowdown limit switch" function.<br><input type="checkbox"/> <b>[No]</b> (nO): Function inactive (the next two parameters will, therefore, be inaccessible).<br><input type="checkbox"/> <b>0.01 yd to 10.94 yd</b> : Stop distance range in yards.   |                  |                   |
| <i>nLS</i>                                    | <input type="checkbox"/> <b>[Rated linear speed]</b><br>The parameter can be accessed if at least one limit switch or one sensor has been assigned.<br>Rated linear speed in meters/second.   | 0.20 to 5.00 m/s | 1.00 m/s          |
| <i>SFd</i>                                    | <input type="checkbox"/> <b>[Stop corrector]</b><br>The parameter can be accessed if at least one limit switch or one sensor has been assigned.<br>Scaling factor applied to the stop distance to compensate, for example, a non-linear ramp.   | 50 to 200%       | 100%              |

## [1.7 APPLICATION FUNCT.] (FUn-)

### Parameter set switching [PARAM. SET SWITCHING]

A set of 1 to 15 parameters from the [1.3 SETTINGS] (SEt-) menu on page 52 can be selected and 2 or 3 different values assigned. These 2 or 3 sets of values can then be switched using 1 or 2 logic inputs or control word bits. This switching can be performed during operation (motor running).

It can also be controlled on the basis of one or two frequency thresholds, whereby each threshold acts as a logic input (0 = threshold not reached, 1 = threshold reached).

|  | Values 1     | Values 2     | Values 3     |
|--|--------------|--------------|--------------|
| Parameter 1  | Parameter 1  | Parameter 1  | Parameter 1  |
| Parameter 2  | Parameter 2  | Parameter 2  | Parameter 2  |
| Parameter 3  | Parameter 3  | Parameter 3  | Parameter 3  |
| Parameter 4  | Parameter 4  | Parameter 4  | Parameter 4  |
| Parameter 5  | Parameter 5  | Parameter 5  | Parameter 5  |
| Parameter 6  | Parameter 6  | Parameter 6  | Parameter 6  |
| Parameter 7  | Parameter 7  | Parameter 7  | Parameter 7  |
| Parameter 8  | Parameter 8  | Parameter 8  | Parameter 8  |
| Parameter 9  | Parameter 9  | Parameter 9  | Parameter 9  |
| Parameter 10                                       | Parameter 10 | Parameter 10 | Parameter 10 |
| Parameter 11                                       | Parameter 11 | Parameter 11 | Parameter 11 |
| Parameter 12                                       | Parameter 12 | Parameter 12 | Parameter 12 |
| Parameter 13                                       | Parameter 13 | Parameter 13 | Parameter 13 |
| Parameter 14                                       | Parameter 14 | Parameter 14 | Parameter 14 |
| Parameter 15                                       | Parameter 15 | Parameter 15 | Parameter 15 |
| Input LI or bit or frequency threshold<br>2 values | 0            | 1            | 0 or 1       |
| Input LI or bit or frequency threshold<br>3 values | 0            | 0            | 1            |



**Note:** Do not modify the parameters in the [1.3 SETTINGS] (SEt-) menu, because any modifications made in this menu ([1.3 SETTINGS] (SEt-)) will be lost on the next power-up. The parameters can be adjusted during operation in the [PARAM. SET SWITCHING] (MLP-) menu, on the active configuration.

**Note:** Parameter set switching cannot be configured from the integrated display terminal.

Parameters can only be adjusted on the integrated display terminal if the function has been configured previously via the graphic display terminal, by PowerSuite or via the bus or communication network. If the function has not been configured, the **MLP-** menu and the **PS1-**, **PS2-**, **PS3-** submenus will not appear.

# [1.7 APPLICATION FUNCT.] (FUn-)

| Code   | Name/Description   | Adjustment range | Factory setting |                     |      |              |    |                |                                     |       |                          |                |                          |        |                                     |                |  |        |  |                  |  |         |  |                  |  |         |  |                  |  |       |  |      |  |       |  |     |      |         |    |              |  |  |  |        |  |  |  |           |  |             |  |    |  |    |       |
|--|--|------------------|-----------------|---------------------|------|--------------|----|----------------|-------------------------------------|-------|--------------------------|----------------|--------------------------|--------|-------------------------------------|----------------|--|--------|--|------------------|--|---------|--|------------------|--|---------|--|------------------|--|-------|--|------|--|-------|--|-----|------|---------|----|--------------|--|--|--|--------|--|--|--|-----------|--|-------------|--|----|--|----|-------|
| <b>PLP -</b>   | <b>■ [PARAM. SET SWITCHING]</b>  |                  |                 |                     |      |              |    |                |                                     |       |                          |                |                          |        |                                     |                |  |        |  |                  |  |         |  |                  |  |         |  |                  |  |       |  |      |  |       |  |     |      |         |    |              |  |  |  |        |  |  |  |           |  |             |  |    |  |    |       |
| <b>CHAR1</b><br>nD<br>FtA<br>F2A<br>LI1<br>-<br>-<br>- | <input type="checkbox"/> <b>[2 parameter sets]</b><br><input type="checkbox"/> <b>[No] (nO)</b> : Function inactive.<br><input type="checkbox"/> <b>[Freq. Th.att.] (FtA)</b> : Switching via <b>[Freq. threshold] (Ftd)</b> page 65.<br><input type="checkbox"/> <b>[Freq. Th. 2 attain.] (F2A)</b> : Switching via <b>[Freq. threshold 2] (Ftd)</b> page 65.<br><input type="checkbox"/> <b>[LI1] (LI1)</b><br>:<br>:<br><input type="checkbox"/> <b>[...] (...)</b> : See the assignment conditions on page 121.<br>Switching 2 parameter sets  |                  | [No] (nO)       |                     |      |              |    |                |                                     |       |                          |                |                          |        |                                     |                |  |        |  |                  |  |         |  |                  |  |         |  |                  |  |       |  |      |  |       |  |     |      |         |    |              |  |  |  |        |  |  |  |           |  |             |  |    |  |    |       |
| <b>CHAR2</b><br>nD<br>FtA<br>F2A<br>LI1<br>-<br>-<br>- | <input type="checkbox"/> <b>[3 parameter sets]</b><br><input type="checkbox"/> <b>[No] (nO)</b> : Function inactive.<br><input type="checkbox"/> <b>[Freq. Th.att.] (FtA)</b> : Switching via <b>[Freq. threshold] (Ftd)</b> page 65.<br><input type="checkbox"/> <b>[Freq. Th. 2 attain.] (F2A)</b> : Switching via <b>[Freq. threshold 2] (Ftd)</b> page 65.<br><input type="checkbox"/> <b>[LI1] (LI1)</b><br>:<br>:<br><input type="checkbox"/> <b>[...] (...)</b> : See the assignment conditions on page 121.<br>Switching 3 parameter sets<br><b>Note:</b> In order to obtain 3 parameter sets, <b>[2 parameter sets]</b> must also be configured.  |                  | [No] (nO)       |                     |      |              |    |                |                                     |       |                          |                |                          |        |                                     |                |  |        |  |                  |  |         |  |                  |  |         |  |                  |  |       |  |      |  |       |  |     |      |         |    |              |  |  |  |        |  |  |  |           |  |             |  |    |  |    |       |
|  | <input type="checkbox"/> <b>[PARAMETER SELECTION]</b><br><p>The parameter can only be accessed on the graphic display terminal if <b>[2 parameter sets]</b> is not <b>[No]</b>. Making an entry in this parameter opens a window containing all the adjustment parameters that can be accessed. Select 1 to 15 parameters using ENT (a tick then appears next to the parameter). Parameter(s) can also be deselected using ENT. Example:</p> <table border="1" data-bbox="419 1234 730 1435"> <thead> <tr> <th colspan="2">PARAMETER SELECTION</th> </tr> <tr> <th colspan="2">1.3 SETTINGS</th> </tr> </thead> <tbody> <tr> <td>Ramp increment</td> <td><input checked="" type="checkbox"/></td> </tr> <tr> <td>-----</td> <td><input type="checkbox"/></td> </tr> <tr> <td>-----</td> <td><input type="checkbox"/></td> </tr> <tr> <td>-----</td> <td><input checked="" type="checkbox"/></td> </tr> </tbody> </table>   |                  |                 | PARAMETER SELECTION |      | 1.3 SETTINGS |    | Ramp increment | <input checked="" type="checkbox"/> | ----- | <input type="checkbox"/> | -----          | <input type="checkbox"/> | -----  | <input checked="" type="checkbox"/> |                |  |        |  |                  |  |         |  |                  |  |         |  |                  |  |       |  |      |  |       |  |     |      |         |    |              |  |  |  |        |  |  |  |           |  |             |  |    |  |    |       |
| PARAMETER SELECTION                                    |  |                  |                 |                     |      |              |    |                |                                     |       |                          |                |                          |        |                                     |                |  |        |  |                  |  |         |  |                  |  |         |  |                  |  |       |  |      |  |       |  |     |      |         |    |              |  |  |  |        |  |  |  |           |  |             |  |    |  |    |       |
| 1.3 SETTINGS   |  |                  |                 |                     |      |              |    |                |                                     |       |                          |                |                          |        |                                     |                |  |        |  |                  |  |         |  |                  |  |         |  |                  |  |       |  |      |  |       |  |     |      |         |    |              |  |  |  |        |  |  |  |           |  |             |  |    |  |    |       |
| Ramp increment   | <input checked="" type="checkbox"/>  |                  |                 |                     |      |              |    |                |                                     |       |                          |                |                          |        |                                     |                |  |        |  |                  |  |         |  |                  |  |         |  |                  |  |       |  |      |  |       |  |     |      |         |    |              |  |  |  |        |  |  |  |           |  |             |  |    |  |    |       |
| -----  | <input type="checkbox"/>   |                  |                 |                     |      |              |    |                |                                     |       |                          |                |                          |        |                                     |                |  |        |  |                  |  |         |  |                  |  |         |  |                  |  |       |  |      |  |       |  |     |      |         |    |              |  |  |  |        |  |  |  |           |  |             |  |    |  |    |       |
| -----  | <input type="checkbox"/>   |                  |                 |                     |      |              |    |                |                                     |       |                          |                |                          |        |                                     |                |  |        |  |                  |  |         |  |                  |  |         |  |                  |  |       |  |      |  |       |  |     |      |         |    |              |  |  |  |        |  |  |  |           |  |             |  |    |  |    |       |
| -----  | <input checked="" type="checkbox"/>  |                  |                 |                     |      |              |    |                |                                     |       |                          |                |                          |        |                                     |                |  |        |  |                  |  |         |  |                  |  |         |  |                  |  |       |  |      |  |       |  |     |      |         |    |              |  |  |  |        |  |  |  |           |  |             |  |    |  |    |       |
| <b>PS1 -</b>   | <input type="checkbox"/> <b>[SET 1]</b><br><p>The parameter can be accessed if at least 1 parameter has been selected in <b>[PARAMETER SELECTION]</b>. Making an entry in this parameter opens a settings window containing the selected parameters <b>in the order in which they were selected</b>.<br/>           With the graphic display terminal :</p> <table border="1" data-bbox="414 1704 1086 1910"> <tr> <td>RDY</td> <td>Term</td> <td>+0.00Hz</td> <td>0A</td> </tr> <tr> <th colspan="4">SET1</th> </tr> <tr> <td>Acceleration :</td> <td></td> <td>9.51 s</td> <td>ENT</td> </tr> <tr> <td>Deceleration :</td> <td></td> <td>9.67 s</td> <td></td> </tr> <tr> <td>Acceleration 2 :</td> <td></td> <td>12.58 s</td> <td></td> </tr> <tr> <td>Deceleration 2 :</td> <td></td> <td>13.45 s</td> <td></td> </tr> <tr> <td>Begin Acc round:</td> <td></td> <td>2.3 s</td> <td></td> </tr> <tr> <td>Code</td> <td></td> <td>Quick</td> <td></td> </tr> </table> <table border="1" data-bbox="775 1704 1086 1910"> <tr> <td>RDY</td> <td>Term</td> <td>+0.00Hz</td> <td>0A</td> </tr> <tr> <th colspan="4">Acceleration</th> </tr> <tr> <td colspan="4" style="text-align: center;">9.51 s</td> </tr> <tr> <td>Min = 0.1</td> <td></td> <td>Max = 999.9</td> <td></td> </tr> <tr> <td>&lt;&lt;</td> <td></td> <td>&gt;&gt;</td> <td>Quick</td> </tr> </table> |                  |                 | RDY                 | Term | +0.00Hz      | 0A | SET1           |                                     |       |                          | Acceleration : |                          | 9.51 s | ENT                                 | Deceleration : |  | 9.67 s |  | Acceleration 2 : |  | 12.58 s |  | Deceleration 2 : |  | 13.45 s |  | Begin Acc round: |  | 2.3 s |  | Code |  | Quick |  | RDY | Term | +0.00Hz | 0A | Acceleration |  |  |  | 9.51 s |  |  |  | Min = 0.1 |  | Max = 999.9 |  | << |  | >> | Quick |
| RDY  | Term   | +0.00Hz          | 0A              |                     |      |              |    |                |                                     |       |                          |                |                          |        |                                     |                |  |        |  |                  |  |         |  |                  |  |         |  |                  |  |       |  |      |  |       |  |     |      |         |    |              |  |  |  |        |  |  |  |           |  |             |  |    |  |    |       |
| SET1   |  |                  |                 |                     |      |              |    |                |                                     |       |                          |                |                          |        |                                     |                |  |        |  |                  |  |         |  |                  |  |         |  |                  |  |       |  |      |  |       |  |     |      |         |    |              |  |  |  |        |  |  |  |           |  |             |  |    |  |    |       |
| Acceleration :   |  | 9.51 s           | ENT             |                     |      |              |    |                |                                     |       |                          |                |                          |        |                                     |                |  |        |  |                  |  |         |  |                  |  |         |  |                  |  |       |  |      |  |       |  |     |      |         |    |              |  |  |  |        |  |  |  |           |  |             |  |    |  |    |       |
| Deceleration :   |  | 9.67 s           |                 |                     |      |              |    |                |                                     |       |                          |                |                          |        |                                     |                |  |        |  |                  |  |         |  |                  |  |         |  |                  |  |       |  |      |  |       |  |     |      |         |    |              |  |  |  |        |  |  |  |           |  |             |  |    |  |    |       |
| Acceleration 2 :                                       |  | 12.58 s          |                 |                     |      |              |    |                |                                     |       |                          |                |                          |        |                                     |                |  |        |  |                  |  |         |  |                  |  |         |  |                  |  |       |  |      |  |       |  |     |      |         |    |              |  |  |  |        |  |  |  |           |  |             |  |    |  |    |       |
| Deceleration 2 :                                       |  | 13.45 s          |                 |                     |      |              |    |                |                                     |       |                          |                |                          |        |                                     |                |  |        |  |                  |  |         |  |                  |  |         |  |                  |  |       |  |      |  |       |  |     |      |         |    |              |  |  |  |        |  |  |  |           |  |             |  |    |  |    |       |
| Begin Acc round:                                       |  | 2.3 s            |                 |                     |      |              |    |                |                                     |       |                          |                |                          |        |                                     |                |  |        |  |                  |  |         |  |                  |  |         |  |                  |  |       |  |      |  |       |  |     |      |         |    |              |  |  |  |        |  |  |  |           |  |             |  |    |  |    |       |
| Code   |  | Quick            |                 |                     |      |              |    |                |                                     |       |                          |                |                          |        |                                     |                |  |        |  |                  |  |         |  |                  |  |         |  |                  |  |       |  |      |  |       |  |     |      |         |    |              |  |  |  |        |  |  |  |           |  |             |  |    |  |    |       |
| RDY  | Term   | +0.00Hz          | 0A              |                     |      |              |    |                |                                     |       |                          |                |                          |        |                                     |                |  |        |  |                  |  |         |  |                  |  |         |  |                  |  |       |  |      |  |       |  |     |      |         |    |              |  |  |  |        |  |  |  |           |  |             |  |    |  |    |       |
| Acceleration   |  |                  |                 |                     |      |              |    |                |                                     |       |                          |                |                          |        |                                     |                |  |        |  |                  |  |         |  |                  |  |         |  |                  |  |       |  |      |  |       |  |     |      |         |    |              |  |  |  |        |  |  |  |           |  |             |  |    |  |    |       |
| 9.51 s   |  |                  |                 |                     |      |              |    |                |                                     |       |                          |                |                          |        |                                     |                |  |        |  |                  |  |         |  |                  |  |         |  |                  |  |       |  |      |  |       |  |     |      |         |    |              |  |  |  |        |  |  |  |           |  |             |  |    |  |    |       |
| Min = 0.1  |  | Max = 999.9      |                 |                     |      |              |    |                |                                     |       |                          |                |                          |        |                                     |                |  |        |  |                  |  |         |  |                  |  |         |  |                  |  |       |  |      |  |       |  |     |      |         |    |              |  |  |  |        |  |  |  |           |  |             |  |    |  |    |       |
| <<   |  | >>               | Quick           |                     |      |              |    |                |                                     |       |                          |                |                          |        |                                     |                |  |        |  |                  |  |         |  |                  |  |         |  |                  |  |       |  |      |  |       |  |     |      |         |    |              |  |  |  |        |  |  |  |           |  |             |  |    |  |    |       |
|  | <p>With the integrated display terminal:<br/>           Proceed as in the Settings menu using the parameters that appear.</p>  |                  |                 |                     |      |              |    |                |                                     |       |                          |                |                          |        |                                     |                |  |        |  |                  |  |         |  |                  |  |         |  |                  |  |       |  |      |  |       |  |     |      |         |    |              |  |  |  |        |  |  |  |           |  |             |  |    |  |    |       |

## [1.7 APPLICATION FUNCT.] (FUn-)

| Code           | Name/Description   | Adjustment range | Factory setting |
|----------------|--|------------------|-----------------|
|                | <b>■ [PARAM. SET SWITCHING]</b> (continued)  |                  |                 |
| <i>P 5 2 -</i> | <input type="checkbox"/> <b>[SET 2]</b><br>The parameter can be accessed if at least 1 parameter has been selected in [PARAMETER SELECTION].<br>Procedure identical to [SET 1] (PS1-).                                       |                  |                 |
| <i>P 5 3 -</i> | <input type="checkbox"/> <b>[SET 3]</b><br>The parameter can be accessed if [3 parameter sets] is not [No] and if at least 1 parameter has been selected in [PARAMETER SELECTION].<br>Procedure identical to [SET 1] (PS1-). |                  |                 |

 **Note:** We recommend that a parameter set switching test is carried out while stopped and a check is made to ensure that it has been performed correctly.  
Some parameters are interdependent and in this case may be restricted at the time of switching.

Interdependencies between parameters must be respected, even between different sets.

Example: The highest [Low speed] (LSP) must be below the lowest [High speed] (HSP).

## [1.7 APPLICATION FUNCT.] (FUn-)

---

### Motor or configuration switching [MULTIMOTORS/CONFIG.]

The drive may contain up to 3 configurations, which can be saved using the [1.12 FACTORY SETTINGS] (FCS-) menu, page 241. Each of these configurations can be activated remotely, enabling adaptation to:

- 2 or 3 different motors or mechanisms (multimotor mode)
- 2 or 3 different configurations for a single motor (multiconfiguration mode)

The two switching modes cannot be combined.



**Note:** The following conditions MUST be observed:

- Switching may only take place when stopped (drive locked). If a switching request is sent during operation, it will not be executed until the next stop.
- In the event of motor switching, the following additional conditions apply:
  - When the motors are switched, the power and control terminals concerned must also be switched as appropriate.
  - The maximum power of the drive must not be exceeded by any of the motors.
- All the configurations to be switched must be set and saved in advance in the same hardware configuration, this being the definitive configuration (option and communication cards). Failure to follow this instruction can cause the drive to lock on an [Incorrect config.] (CFF) fault.

### Menu and parameters switched in multimotor mode

- [1.3 SETTINGS] (SEt-)
- [1.4 MOTOR CONTROL] (drC-)
- [1.5 INPUTS / OUTPUTS CFG] (I-O-)
- [1.6 COMMAND] (CtL-)
- [1.7 APPLICATION FUNCT.] (FUn-) with the exception of the [MULTIMOTORS/CONFIG.] function (to be configured once only)
- [1.8 FAULT MANAGEMENT] (FLt)
- [1.13 USER MENU]
- [USER CONFIG.]: The name of the configuration specified by the user in the [1.12 FACTORY SETTINGS] (FCS-) menu

### Menu and parameters switched in multiconfiguration mode

As in multimotor mode, except for the motor parameters that are common to the three configurations:

- Rated current
- Thermal current
- Rated voltage
- Rated frequency
- Rated speed
- Rated power
- IR compensation
- Slip compensation
- Synchronous motor parameters
- Type of thermal protection
- Thermal state
- The auto-tuning parameters and motor parameters that can be accessed in expert mode
- Type of motor control



**Note:** No other menus or parameters can be switched.

## [1.7 APPLICATION FUNCT.] (FUn-)

### Switching command

Depending on the number of motors or selected configuration (2 or 3), the switching command is sent using one or two logic inputs. The table below lists the possible combinations.

| LI<br>2 motors or configurations | LI<br>3 motors or configurations | Number of configuration<br>or active motor |
|----------------------------------|----------------------------------|--|
| 0                                | 0                                | 0  |
| 1                                | 0                                | 1  |
| 0                                | 1                                | 2  |
| 1                                | 1                                | 2  |

### Schematic diagram for multimotor mode

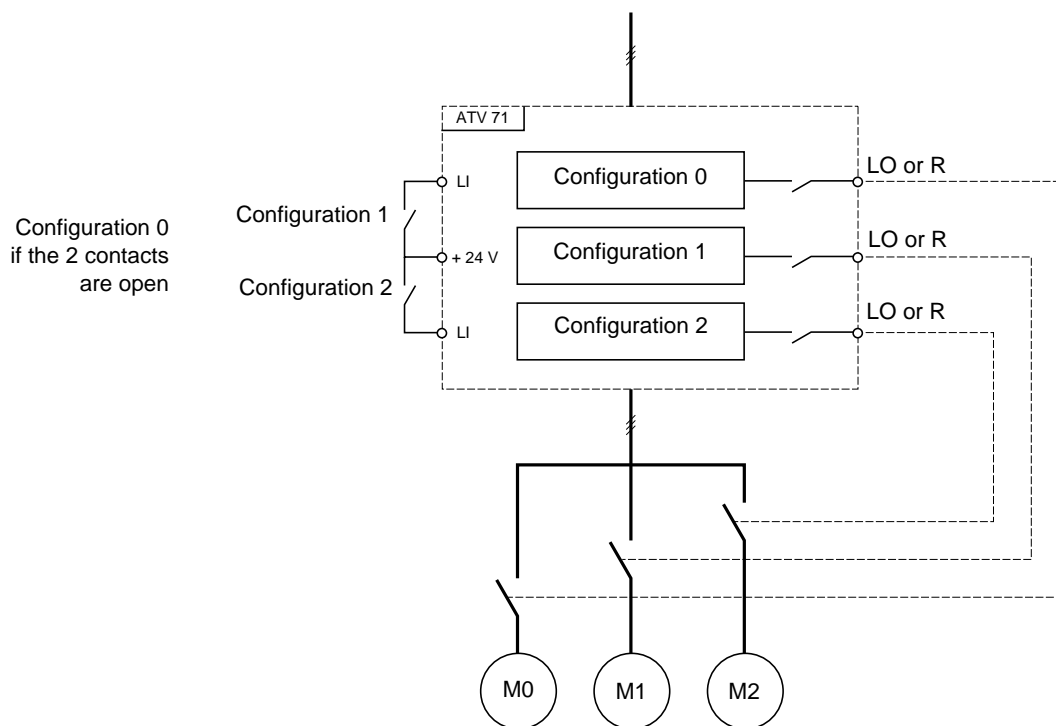

### Auto-tuning in multimotor mode

This auto-tuning can be performed:

- Manually using a logic input when the motor changes
- Automatically each time the motor is activated for the 1<sup>st</sup> time after switching on the drive, if the [Automatic autotune] (AUt) parameter on page 68 = [Yes] (YES).

### Motor thermal states in multimotor mode:

The drive protects the three motors individually. Each thermal state takes into account all stop times, including drive shutdowns.

It is, therefore, not necessary to perform auto-tuning every time the power is switched on. It is sufficient to auto-tune each motor at least once.

### Configuration information output

In the [1.5 INPUTS / OUTPUTS CFG] (I-O-) menu, a logic output can be assigned to each configuration or motor (2 or 3) for remote information transmission.

 **Note:** As the [1.5 INPUTS / OUTPUTS CFG] (I-O-) menu is switched, these outputs must be assigned in all configurations in which information is required.

# [1.7 APPLICATION FUNCT.] (FUn-)

| Code   | Name/Description   | Adjustment range | Factory setting |
|--|--|------------------|-----------------|
| <b>nnC -</b>   | <b>■ [MULTIMOTORS/CONFIG.]</b>   |                  |                 |
| <b>CnF0</b><br>nO<br>YES                                       | <input type="checkbox"/> <b>[Multimotors]</b><br><input type="checkbox"/> <b>[No] (nO)</b> : Multiconfiguration possible<br><input type="checkbox"/> <b>[Yes] (YES)</b> : Multimotor possible  |                  | [No] (nO)       |
| <b>CnF1</b><br>nO<br>L I I<br>-<br>-<br>C I I I<br>-<br>-<br>- | <input type="checkbox"/> <b>[2 Configurations]</b><br><input type="checkbox"/> <b>[No] (nO)</b> : No switching<br><input type="checkbox"/> <b>[LI1] (LI1) to [LI6] (LI6)</b><br><input type="checkbox"/> <b>[LI7] (LI7) to [LI10] (LI10)</b> : If VW3A3201 logic I/O card has been inserted<br><input type="checkbox"/> <b>[LI11] (LI11) to [LI14] (LI14)</b> : If VW3A3202 extended I/O card has been inserted<br><input type="checkbox"/> <b>[C111] (C111) to [C115] (C115)</b> : With integrated Modbus<br><input type="checkbox"/> <b>[C211] (C211) to [C215] (C215)</b> : With integrated CANopen<br><input type="checkbox"/> <b>[C311] (C311) to [C315] (C315)</b> : With a communication card<br><input type="checkbox"/> <b>[C411] (C411) to [C415] (C415)</b> : With a Controller Inside card<br><br>Switching of 2 motors or 2 configurations  |                  | [No] (nO)       |
| <b>CnF2</b><br>nO<br>L I I<br>-<br>-<br>C I I I<br>-<br>-<br>- | <input type="checkbox"/> <b>[3 Configurations]</b><br><input type="checkbox"/> <b>[No] (nO)</b> : No switching<br><input type="checkbox"/> <b>[LI1] (LI1) to [LI6] (LI6)</b><br><input type="checkbox"/> <b>[LI7] (LI7) to [LI10] (LI10)</b> : If VW3A3201 logic I/O card has been inserted<br><input type="checkbox"/> <b>[LI11] (LI11) to [LI14] (LI14)</b> : If VW3A3202 extended I/O card has been inserted<br><input type="checkbox"/> <b>[C111] (C111) to [C115] (C115)</b> : With integrated Modbus<br><input type="checkbox"/> <b>[C211] (C211) to [C215] (C215)</b> : With integrated CANopen<br><input type="checkbox"/> <b>[C311] (C311) to [C315] (C315)</b> : With a communication card<br><input type="checkbox"/> <b>[C411] (C411) to [C415] (C415)</b> : With a Controller Inside card<br><br>Switching of 3 motors or 3 configurations<br><br><b>Note:</b> In order to obtain 3 motors or 3 configurations, <b>[2 Configurations] (CnF1)</b> must also be configured. |                  | [No] (nO)       |
| <b>EnL -</b>   | <b>■ [AUTO TUNING BY LI]</b>   |                  |                 |
| <b>EUL</b><br>nO<br>L I I<br>-<br>-<br>-                       | <input type="checkbox"/> <b>[Auto-tune assign.]</b><br><input type="checkbox"/> <b>[No] (nO)</b> : Not assigned<br><input type="checkbox"/> <b>[LI1] (LI1)</b><br>:<br>:<br><input type="checkbox"/> <b>[...] (...)</b> : See the assignment conditions on page <a href="#">121</a> .<br>Auto-tuning is performed when the assigned input or bit changes to 1.<br><br> <b>Note:</b> Auto-tuning causes the motor to start up.   |                  | [No] (nO)       |

## Traverse control

Function for winding reels of yarn (in textile applications)

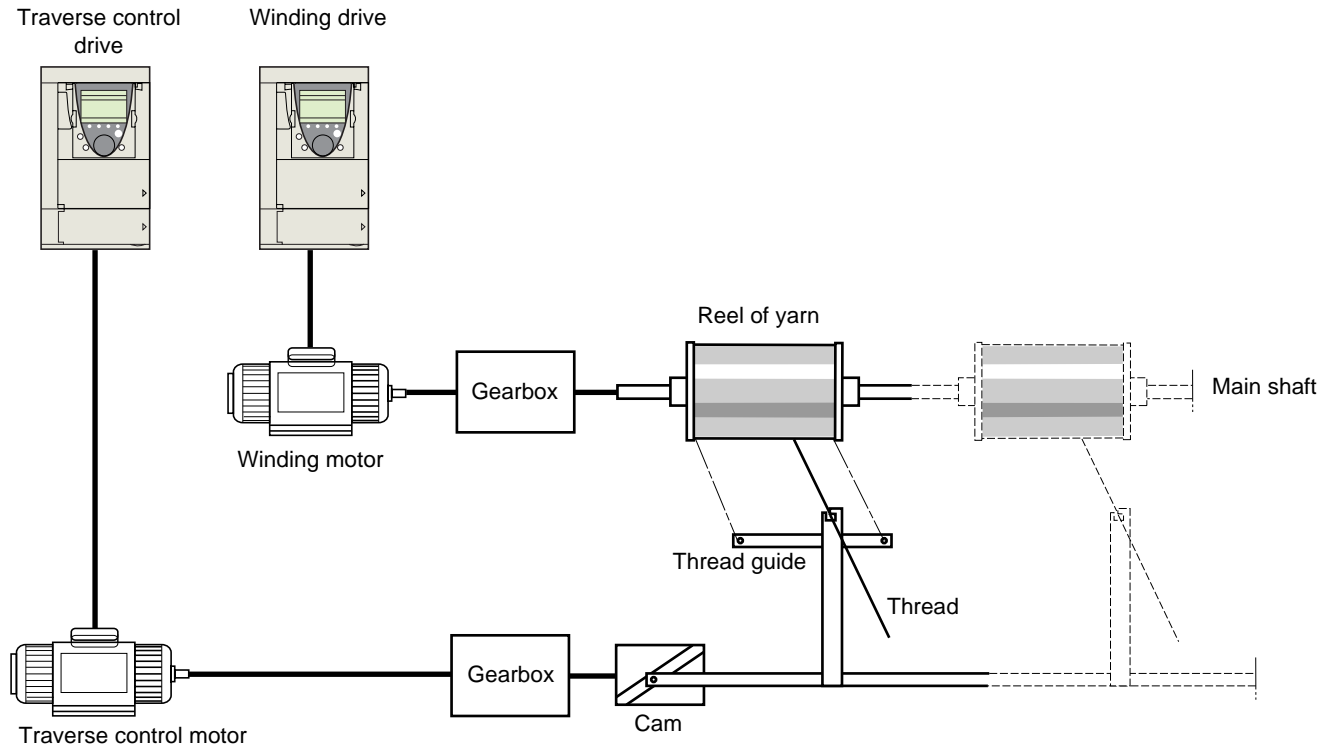

The speed of rotation of the cam must follow a precise profile to ensure that the reel is steady, compact and linear:

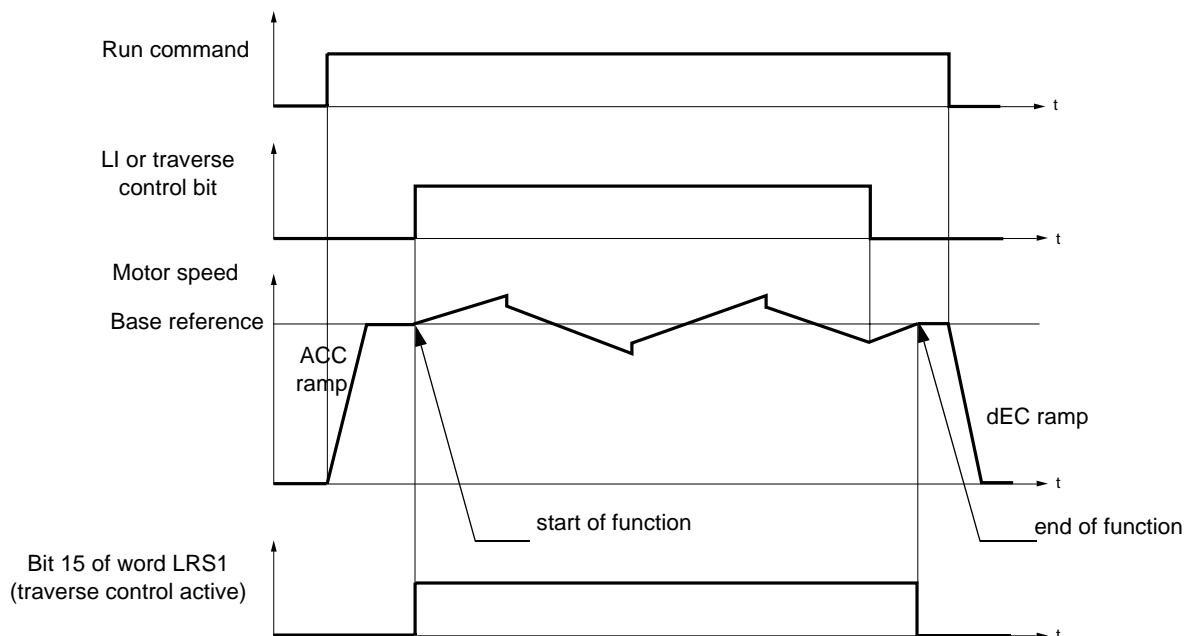

The function starts when the drive has reached its base reference and the traverse control command has been enabled. When the traverse control command is disabled, the drive returns to its base reference, following the ramp determined by the traverse control function. The function then stops, as soon as it has returned to this reference. Bit 15 of word LRS1 is at 1 while the function is active.



## [1.7 APPLICATION FUNCT.] (FUn-)

### Function parameters:

These define the cycle of frequency variations around the base reference, as shown in the diagram below:

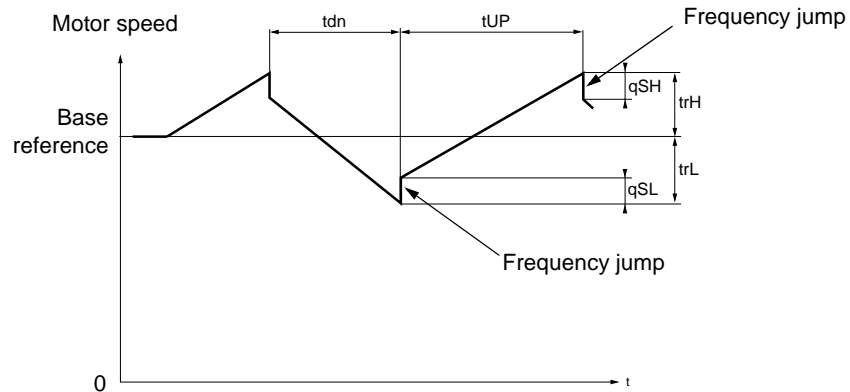

- trC: [Yarn control]: Assignment of the traverse control command to a logic input or to a communication bus control word bit
- tdn: [Traverse ctrl. decel] time, in seconds
- tUP: [Traverse ctrl. accel.] time, in seconds
- trH: [Traverse freq. high], in Hertz
- trL: [Traverse Freq. Low], in Hertz
- qSH: [Quick step High], in Hertz
- qSL: [Quick step Low], in Hertz

### Reel parameters:

- tbO: [Reel time]: Time taken to make a reel, in minutes.  
This parameter is intended to signal the end of winding. When the traverse control operating time since command trC reaches the value of tbO, the logic output or one of the relays changes to state 1, if the corresponding function EbO has been assigned.  
The traverse control operating time EbOt can be monitored online by a communication bus and in the Monitoring menu.
- dtF: [Decrease ref. speed]: Decrease in the base reference.  
In certain cases, the base reference has to be reduced as the reel increases in size. The dtF value corresponds to time tbO. Once this time has elapsed, the reference continues to fall, following the same ramp. If low speed LSP is at 0, the speed reaches 0 Hz, the drive stops and must be reset by a new run command.  
If low speed LSP is not 0, the traverse control function continues to operate above LSP.

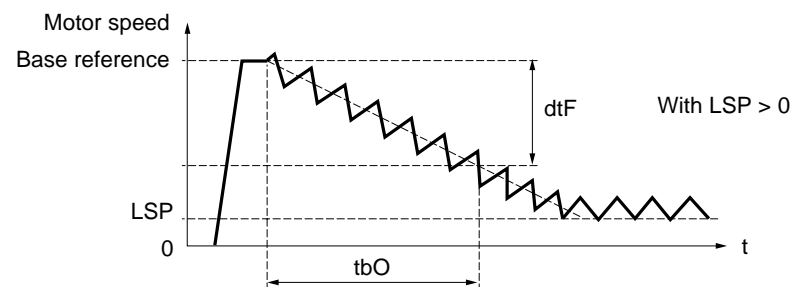
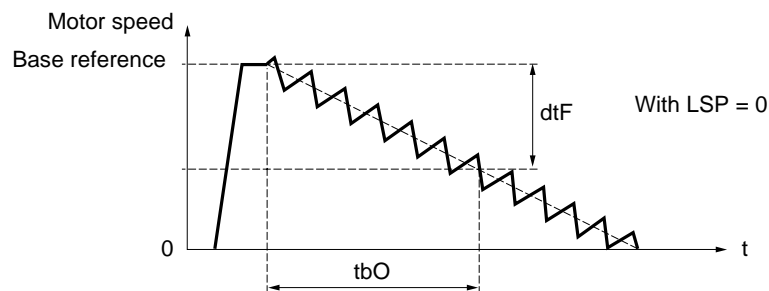

## [1.7 APPLICATION FUNCT.] (FUn-)

- rtr:** [\[Init. traverse ctrl\]](#) Reinitialize traverse control.  
 This command can be assigned to a logic input or to a communication bus control word bit. It resets the EbO alarm and the EbOt operating time to zero and reinitializes the reference to the base reference. As long as rtr remains at 1, the traverse control function is disabled and the speed remains the same as the base reference. This command is used primarily when changing reels.

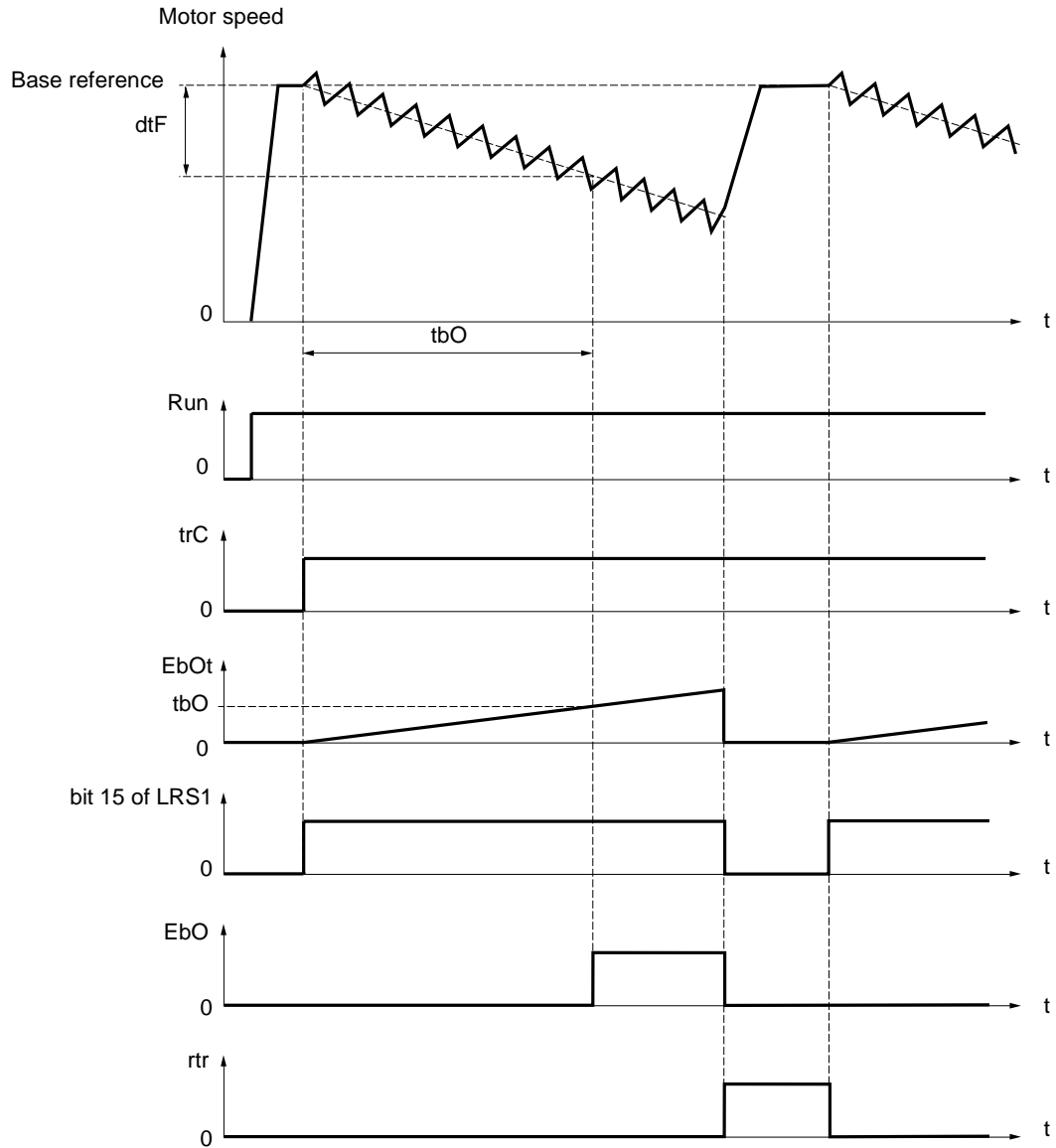

Counter wobble

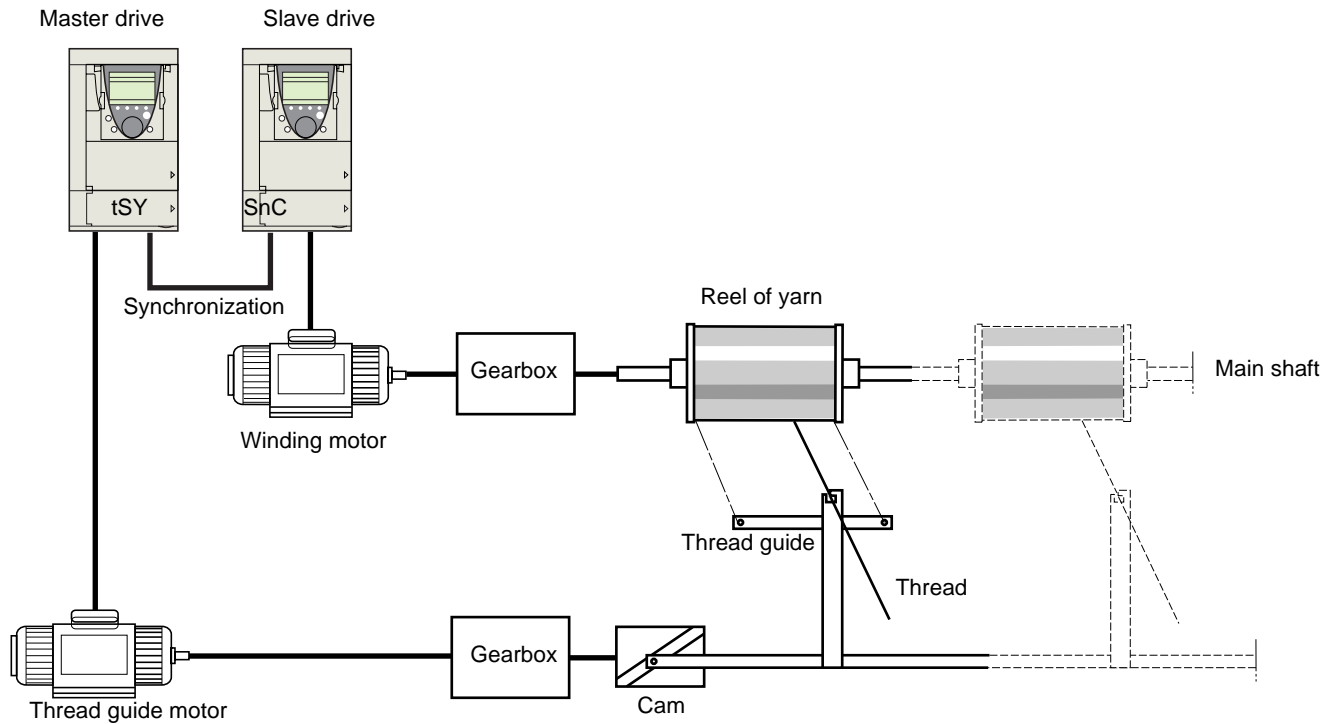

The "Counter wobble" function is used in certain applications to obtain a constant yarn tension when the "Traverse control" function is producing considerable variations in speed on the yarn guide motor ( $trH$  and  $trL$ , see page 205).

**Two motors must be used (one master and one slave).**

The master controls the speed of the yarn guide, the slave controls the winding speed. The function assigns the slave a speed profile, which is in antiphase to that of the master. This means that synchronization is required, using one of the master's logic outputs and one of the slave's logic inputs.

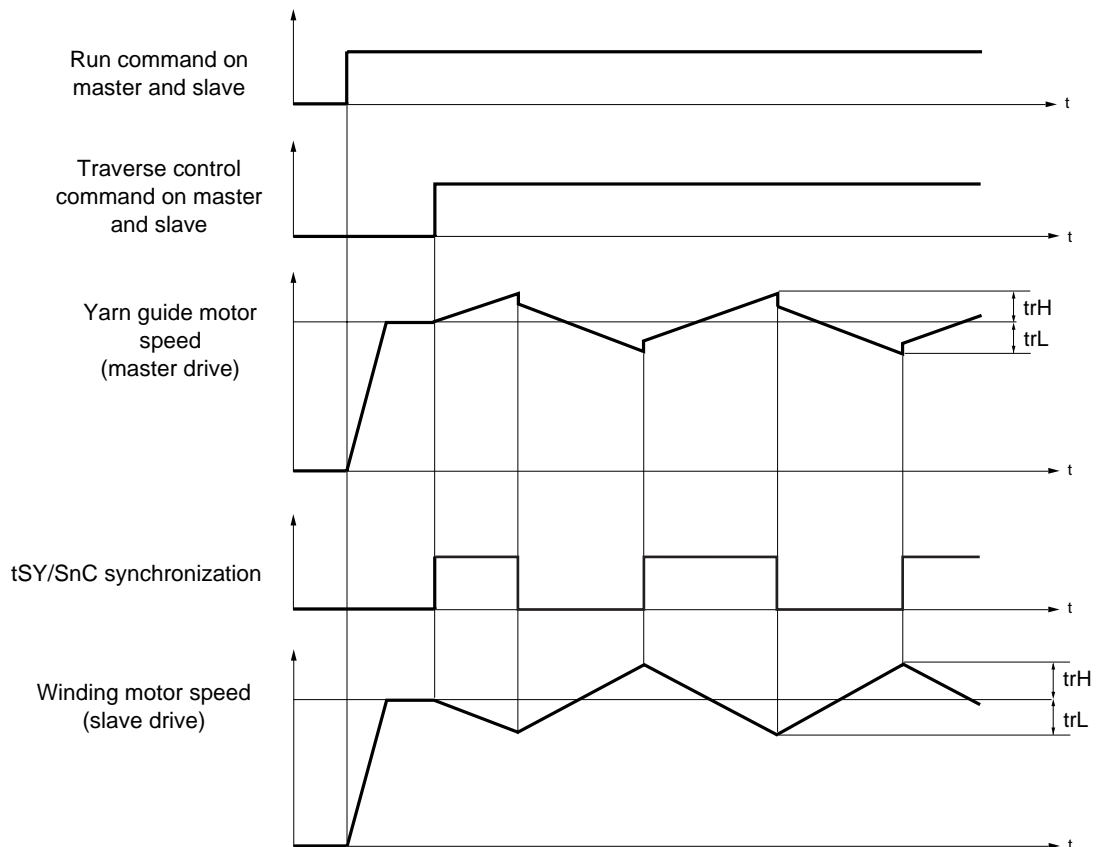

## [1.7 APPLICATION FUNCT.] (FUn-)

### Connection of synchronization I/O

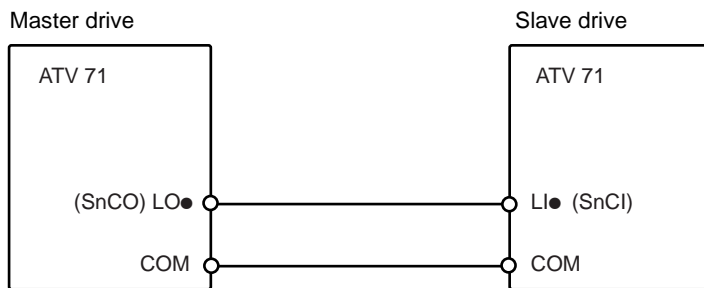

The starting conditions for the function are:

- Base speeds reached on both drives
- [Yarn control] (trC) input activated
- Synchronization signal present

**Note:** On the slave drive, the [Quick step High] (qSH) and [Quick step Low] (qSL) parameters should generally be left at zero.

# [1.7 APPLICATION FUNCT.] (FUn-)

| Code   | Name/Description  | Adjustment range                                     | Factory setting |
|--|---|--|-----------------|
| <b>ErD-</b>  | <div style="background-color: #00b0f0; color: white; padding: 5px;"> <b>[TRAVERSE CONTROL]</b><br/> <b>Note:</b> This function cannot be used with certain other functions. Follow the instructions on page <a href="#">127</a>.                 </div>   |  |                 |
| ErC<br>nD<br>L I I<br>-<br>-<br>-                    | <input type="checkbox"/> <b>[Yarn control]</b><br><input type="checkbox"/> <b>[No]</b> (nO): Function inactive, thereby preventing access to other parameters.<br><input type="checkbox"/> <b>[LI1]</b> (LI1)<br>...<br><input type="checkbox"/> <b>[...]</b> (...): See the assignment conditions on page <a href="#">121</a> .<br>The "traverse control" cycle starts when the assigned input or bit changes to 1 and stops when it changes to 0.   |  | [No] (nO)       |
| ErH<br>(↻)   | <input type="checkbox"/> <b>[Traverse freq. high]</b>   | (1) 0 to 10 Hz                                       | 4 Hz            |
| ErL<br>(↻)   | <input type="checkbox"/> <b>[Traverse Freq. Low]</b>  | (1) 0 to 10 Hz                                       | 4 Hz            |
| qSH<br>(↻)   | <input type="checkbox"/> <b>[Quick step High]</b>   | (1) 0 to <a href="#">[Traverse freq. high]</a> (trH) | 0 Hz            |
| qSL<br>(↻)   | <input type="checkbox"/> <b>[Quick step Low]</b>  | (1) 0 to <a href="#">[Traverse Freq. Low]</a> (trL)  | 0 Hz            |
| tUP<br>(↻)   | <input type="checkbox"/> <b>[Traverse ctrl. accel.]</b>   | 0.1 to 999.9 s                                       | 4 s             |
| tDn<br>(↻)   | <input type="checkbox"/> <b>[Traverse ctrl. decel]</b>  | 0.1 to 999.9 s                                       | 4 s             |
| tBO<br>(↻)   | <input type="checkbox"/> <b>[Reel time]</b><br>Reel execution time  | 0 to 9999 minutes                                    | 0 minute        |
| EBO<br>nD<br>LO1<br>-<br>LO4<br>r2<br>-<br>r4<br>dO1 | <input type="checkbox"/> <b>[End reel]</b><br><input type="checkbox"/> <b>[No]</b> (nO): Function not assigned.<br><input type="checkbox"/> <b>[LO1]</b> (LO1) to <b>[LO4]</b> (LO4): Logic output (if one or two I/O cards have been inserted, LO1 to LO2 or LO4 can be selected).<br><input type="checkbox"/> <b>[R2]</b> (r2) to <b>[R4]</b> (r4): Relay (selection of R2 extended to R3 or R4 if one or two I/O cards have been inserted).<br><input type="checkbox"/> <b>[dO1]</b> (dO1): Analog output AO1 functioning as a logic output. Selection can be made if <a href="#">[AO1 assignment]</a> (AO1) page <a href="#">108</a> = <b>[No]</b> (nO).<br>The assigned output or relay changes to state 1 when the traverse control operating time reaches the <a href="#">[Reel time]</a> (tbO). |  | [No] (nO)       |

(1) The parameter can also be accessed in the [\[1.3 SETTINGS\]](#) (SEt-) menu.

Parameter that can be modified during operation or when stopped.

# [1.7 APPLICATION FUNCT.] (FUn-)

Textiles

| Code  | Name/Description  | Adjustment range | Factory setting |
|---|---|------------------|-----------------|
| <b>■ [TRAVERSE CONTROL] (continued)</b>   |   |                  |                 |
| <b>S n C</b><br><br>n 0<br>L 1 1<br>-<br>-<br>-   | <input type="checkbox"/> <b>[Counter wobble]</b><br><br><input type="checkbox"/> <b>[No] (nO)</b> : Function not assigned.<br><input type="checkbox"/> <b>[LI1] (LI1)</b><br>⋮<br><input type="checkbox"/> <b>[...] (...)</b> : See the assignment conditions on page 121.<br>Synchronization input.<br>To be configured on the winding drive (slave) only.   |                  | [No] (nO)       |
| <b>E S Y</b><br><br>n 0<br>L 0 1<br>-<br>L 0 4<br>r 2<br>-<br>r 4<br>d 0 1                          | <input type="checkbox"/> <b>[Sync. wobble]</b><br><br><input type="checkbox"/> <b>[No] (nO)</b> : Function not assigned.<br><input type="checkbox"/> <b>[LO1] (LO1)</b><br>to<br><input type="checkbox"/> <b>[LO4] (LO4)</b> : Logic output (if one or two I/O cards have been inserted, LO1 to LO2 or LO4 can be selected).<br><input type="checkbox"/> <b>[R2] (r2)</b><br>to<br><input type="checkbox"/> <b>[R4] (r4)</b> : Relay (selection of R2 extended to R3 or R4 if one or two I/O cards have been inserted).<br><input type="checkbox"/> <b>[dO1] (dO1)</b> : Analog output AO1 functioning as a logic output. Selection can be made if <a href="#">[AO1 assignment] (AO1)</a> page 108 = [No] (nO).<br>Synchronization output.<br>To be configured on the yarn guide drive (master) only. |                  | [No] (nO)       |
| <b>d t F</b><br> | <input type="checkbox"/> <b>[Decrease ref. speed]</b><br><br>Decrease in the base reference during the traverse control cycle.  | 0 to 1600 Hz     | 0 Hz            |
| <b>r t r</b><br><br>n 0<br>L 1 1<br>-<br>-<br>-   | <input type="checkbox"/> <b>[Init. traverse ctrl]</b><br><br><input type="checkbox"/> <b>[No] (nO)</b> : Function not assigned.<br><input type="checkbox"/> <b>[LI1] (LI1)</b><br>⋮<br><input type="checkbox"/> <b>[...] (...)</b> : See the assignment conditions on page 121.<br>When the state of the assigned input or bit changes to 1, the traverse control operating time is reset to zero, along with <a href="#">[Decrease ref. speed] (dtF)</a> .   |                  | [No] (nO)       |

## [1.7 APPLICATION FUNCT.] (FUn-)

### Evacuation function

The evacuation function is designed for "elevator" applications. It is only accessible for ATV71●●●N4 (380/480 V) drives, up to 75 kW (100 HP) only.

When an elevator is stuck between 2 floors due to a power outage, it must be possible to evacuate its occupants within a reasonable period of time.

This function requires an emergency power supply to be connected to the drive.

This power supply is at a reduced voltage, and only allows a derated operating mode, at reduced speed, but with full torque.

The function requires:

- One logic input to control "evacuation" operation
- Reduction of the voltage monitoring threshold
- An appropriate low speed reference

Following a power outage and **turning off of the drive**, the latter can be powered up again without going into [Undervoltage] (USF) fault mode if the corresponding control bit or logic input is at 1 at the same time. It is then possible to control ascent (FW) or descent (RV).

### CAUTION

- This input must not be at 1 when the drive is powered from the line supply. To ensure this and also avoid any short-circuits, supply changeover contactors must be used.
- Set this input to 0 before connecting the emergency power supply to the line supply.

**Failure to follow these instructions can result in equipment damage.**

| Code                                    | Name/Description  | Adjustment range | Factory setting |
|---|---|------------------|-----------------|
| r F E -                                 | <b>[EVACUATION]</b><br>Function only accessible for ATV71●●●N4 (380/480 V) drives, up to 75 kW (100 HP) only.   |                  |                 |
| r F E -<br>r D<br>L I 1<br>-<br>L I 1 4 | <input type="checkbox"/> <b>[Evacuation assign.]</b><br><input type="checkbox"/> [No] (nO): Function not assigned.<br><input type="checkbox"/> [LI1] (LI1) to [LI6] (LI6)<br><input type="checkbox"/> [LI7] (LI7) to [LI10] (LI10): If VW3A3201 logic I/O card has been inserted<br><input type="checkbox"/> [LI11] (LI11) to [LI14] (LI14): If VW3A3202 extended I/O card has been inserted.<br>Evacuation is activated when the assigned input is at 1, if the drive is stationary.<br>Evacuation is activated when the assigned input is at 0, as soon as the drive stops.       |                  | [No] (nO)       |
| r S U                                   | <input type="checkbox"/> <b>[Evacuation Input V.]</b><br>Minimum permissible AC voltage value of the emergency power supply.<br>The parameter can be accessed if [Evacuation assign.] (rFt) is not [No] (nO).   | 220 to 320 V     | 220 V           |
| r S P<br>( )                            | <input type="checkbox"/> <b>[Evacuation freq.]</b><br>Value of the "evacuation" mode frequency reference.<br>The parameter can be accessed if [Evacuation assign.] (rFt) is not [No] (nO).<br>The adjustment range is determined by the [Low speed] (LSP) (page 54), [Rated motor freq.] (FrS) and [Rated motor volt.] (UnS) (page 67) parameters and by [Evacuation Input V.] (rSU) above. <ul style="list-style-type: none"> <li>• If LSP &lt; (FrS x rSU/UnS): rSP min. = LSP, rSP max. = (FrS x rSU/UnS)</li> <li>• If LSP ≥ (FrS x rSU/UnS): rSP = (FrS x rSU/UnS).</li> </ul> |                  | 5 Hz            |

( ) Parameter that can be modified during operation or when stopped.

# [1.7 APPLICATION FUNCT.] (FUn-)

## Half floor

The "half floor" function is designed for "elevator" applications.

When an elevator sets off from floors and half floors, the cycle time for half floors can be too long, as the elevator does not have time to reach full speed before crossing the slowdown limit switch. As a result, the slowdown time is unnecessarily long.

The "half floor" function can be used to compensate this by not triggering slowdown until the speed reaches a preset threshold [Half-floor speed] (HLS) in order that the final part of the path will be the same as for a standard floor.

The graphs below illustrate the various operating scenarios with and without the function:

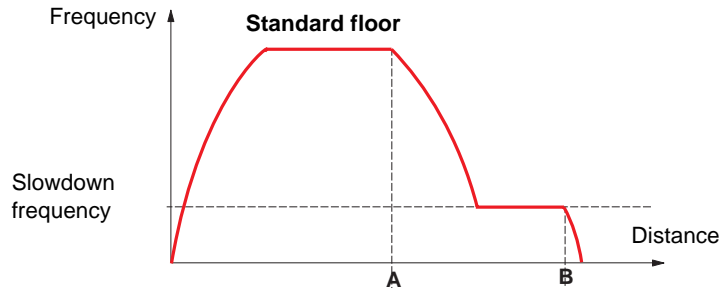

**A:** Slowdown limit switch reached  
**B:** Stop limit switch reached

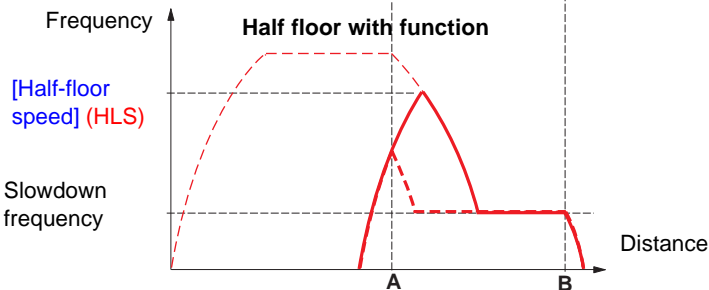
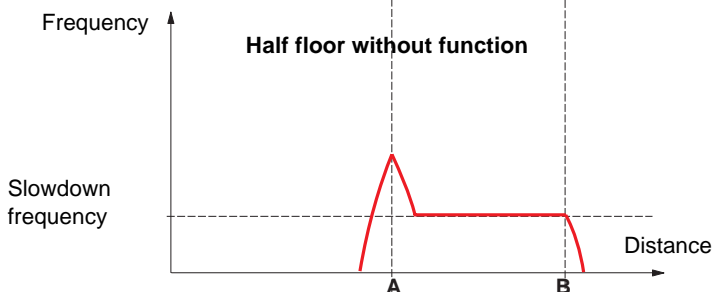

The function is only activated if, when the slowdown limit switch is tripped, the motor frequency is less than [Half-floor speed] (HLS). Acceleration is then maintained up to this value prior to slowing down. The final part of the path is identical to that of the standard floor.

| Code  | Name/Description  | Adjustment range | Factory setting |
|-------|---|------------------|-----------------|
| HFF - | <input checked="" type="checkbox"/> [HALF FLOOR]  |                  |                 |
| HLS   | <input type="checkbox"/> [Half-floor speed]   |                  | [No] (nO)       |
| nO    | <p>Activation and adjustment of the "half floor" function. This function has priority over all speed reference functions (preset speeds, for example) with the exception of those generated via fault monitoring (fallback speed, for example).</p> <p><input type="checkbox"/> [No] (nO): Function inactive</p> <p><input type="checkbox"/> 0.1 Hz to 500.0 Hz: Activation of the function by adjusting the motor frequency to be reached prior to slowing down.</p> |                  |                 |



## [1.7 APPLICATION FUNCT.] (FUn-)

### Direct power supply via DC bus

This function is only accessible for ATV71●●●M3 ≥ 18.5 kW (25 HP) and ATV71●●●N4 □ 18.5 kW (25 HP) drives.

Direct power supply via the DC bus requires a protected direct current source with adequate power and voltage as well as a suitably dimensioned resistor and capacitor precharging contactor. Consult Schneider Electric for information about specifying these components.

The "direct power supply via DC bus" function can be used to control the precharging contactor via a relay or a logic input on the drive.

Example circuit using R2 relay:

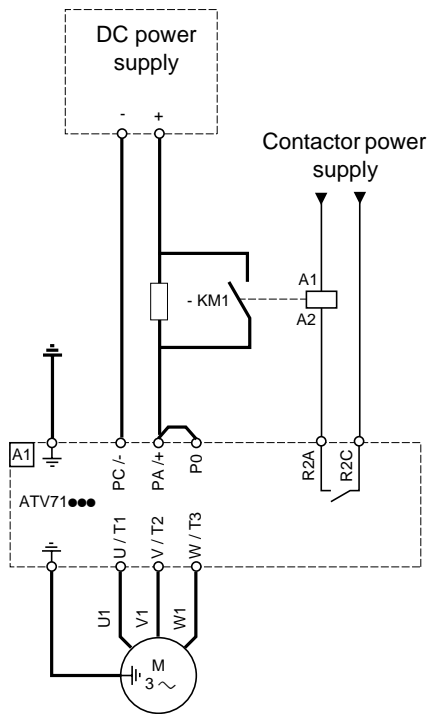

| Code        | Name/Description  | Adjustment range | Factory setting  |
|-------------|---|------------------|------------------|
| <b>dC0-</b> | <b>■ [DC BUS SUPPLY]</b><br>This function is only accessible for ATV71●●●M3 drives ≥ 18.5 kW (25 HP) and ATV71●●●N4 drives □ 18.5 kW (25 HP).   |                  |                  |
| <b>dC0</b>  | <b>□ [Precharge cont. ass.]</b><br>Logic output or control relay<br><input type="checkbox"/> <b>[No]</b> (nO): Function not assigned.<br><input type="checkbox"/> <b>[LO1]</b> (LO1)<br>to<br><b>[LO4]</b> (LO4): Logic output (if one or two I/O cards have been inserted, LO1 to LO2 or LO4 can be selected).<br><input type="checkbox"/> <b>[R2]</b> (r2)<br>to<br><b>[R4]</b> (r4): Relay (selection of R2 extended to R3 or R4 if one or two I/O cards have been inserted).<br><input type="checkbox"/> <b>[dO1]</b> (dO1): Analog output AO1 functioning as a logic output. Selection can be made if <b>[AO1 assignment]</b> (AO1) page 108 = <b>[No]</b> (nO). |                  | <b>[No]</b> (nO) |
| <b>nO</b>   |   |                  |                  |
| <b>LO1</b>  |   |                  |                  |
| <b>LO4</b>  |   |                  |                  |
| <b>r2</b>   |   |                  |                  |
| <b>r4</b>   |   |                  |                  |
| <b>dO1</b>  |   |                  |                  |

# [1.8 FAULT MANAGEMENT] (FLt-)

With graphic display terminal:

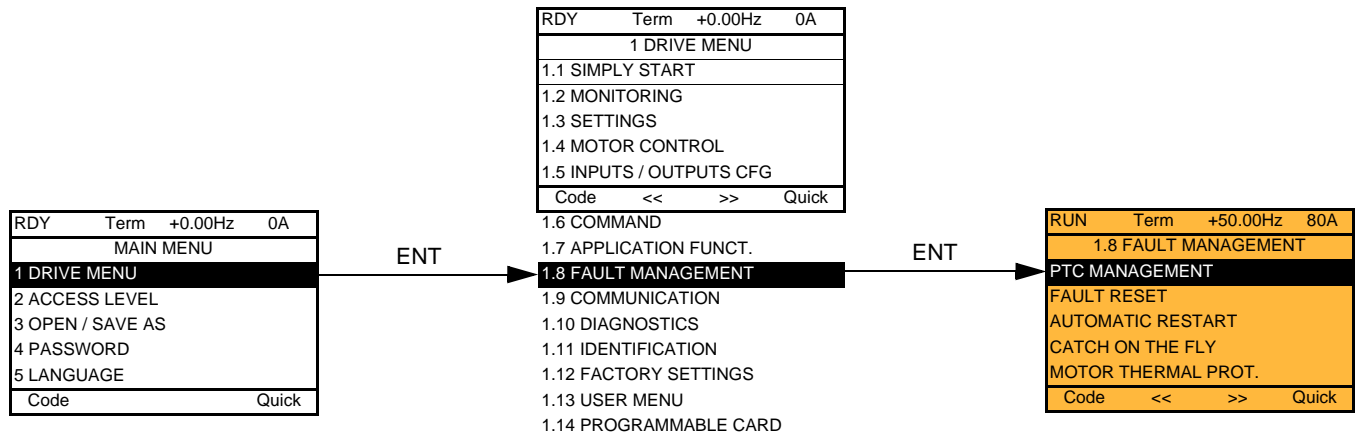

With integrated display terminal:

Summary of functions:

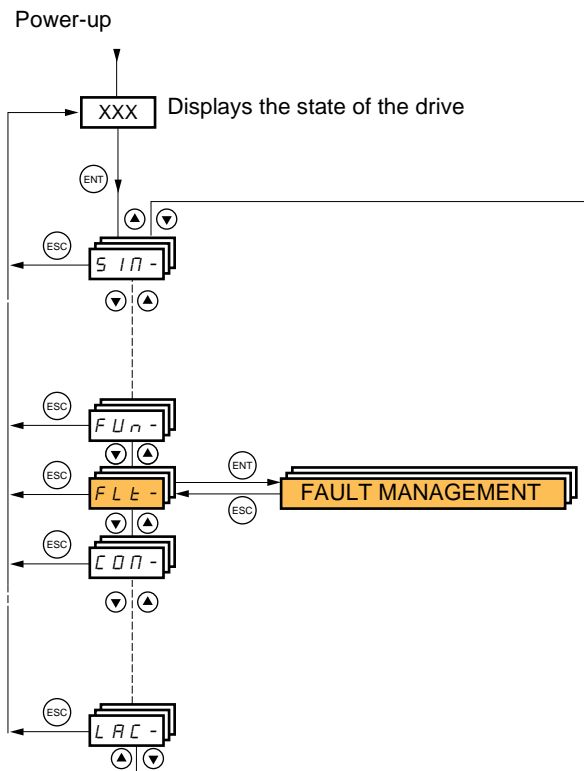

| Code        | Name                      | Page                |
|-------------|---------------------------|---------------------|
| <i>PtC-</i> | [PTC MANAGEMENT]          | <a href="#">212</a> |
| <i>rSt-</i> | [FAULT RESET]             | <a href="#">213</a> |
| <i>ARr-</i> | [AUTOMATIC RESTART]       | <a href="#">214</a> |
| <i>FLr-</i> | [CATCH ON THE FLY]        | <a href="#">215</a> |
| <i>tHt-</i> | [MOTOR THERMAL PROT.]     | <a href="#">217</a> |
| <i>OPt-</i> | [OUTPUT PHASE LOSS]       | <a href="#">217</a> |
| <i>IPt-</i> | [INPUT PHASE LOSS]        | <a href="#">218</a> |
| <i>OHt-</i> | [DRIVE OVERHEAT]          | <a href="#">218</a> |
| <i>SAt-</i> | [THERMAL ALARM STOP]      | <a href="#">219</a> |
| <i>EtF-</i> | [EXTERNAL FAULT]          | <a href="#">220</a> |
| <i>USt-</i> | [UNDERVOLTAGE MGT]        | <a href="#">221</a> |
| <i>tIt-</i> | [IGBT TESTS]              | <a href="#">222</a> |
| <i>LFL-</i> | [4-20mA LOSS]             | <a href="#">223</a> |
| <i>InH-</i> | [FAULT INHIBITION]        | <a href="#">224</a> |
| <i>CLL-</i> | [COM. FAULT MANAGEMENT]   | <a href="#">225</a> |
| <i>Sdt-</i> | [ENCODER FAULT]           | <a href="#">226</a> |
| <i>tId-</i> | [TORQUE OR I LIM. DETECT] | <a href="#">226</a> |
| <i>FqF-</i> | [FREQUENCY METER]         | <a href="#">228</a> |
| <i>dLd-</i> | [DYNAMIC LOAD DETECT.]    | <a href="#">230</a> |
| <i>brP-</i> | [DB RES. PROTECTION]      | <a href="#">231</a> |
| <i>bUF-</i> | [BU PROTECTION]           | <a href="#">231</a> |
| <i>tnt-</i> | [AUTO TUNING FAULT]       | <a href="#">231</a> |
| <i>PPt-</i> | [CARDS PAIRING]           | <a href="#">232</a> |
| <i>LFF-</i> | [FALLBACK SPEED]          | <a href="#">233</a> |
| <i>FSt-</i> | [RAMP DIVIDER]            | <a href="#">233</a> |
| <i>dCI-</i> | [DC INJECTION]            | <a href="#">233</a> |

## [1.8 FAULT MANAGEMENT] (FLt-)

---

The parameters in the [1.8 FAULT MANAGEMENT] (FLt-) menu can only be modified when the drive is stopped and there is no run command, except for parameters with a  symbol in the code column, which can be modified with the drive running or stopped.

### PTC probes

3 sets of PTC probes can be managed by the drive in order to protect the motors:

- 1 on logic input LI6 converted for this use by switch "SW2" on the control card.
- 1 on each of the 2 option cards VW3A3201 and VW3A3202.

Each of these sets of PTC probes is monitored for the following faults:

- Motor overheating
- Sensor break fault
- Sensor short-circuit fault

Protection via PTC probes does not disable protection via  $I^2t$  calculation performed by the drive (the two types of protection can be combined).

## [1.8 FAULT MANAGEMENT] (FLt-)

| Code         | Name/Description  | Adjustment range | Factory setting  |
|--------------|---|------------------|------------------|
| <b>PTC -</b> | <b>■ [PTC MANAGEMENT]</b>   |                  |                  |
| <b>PTCL</b>  | <input type="checkbox"/> <b>[LI6 = PTC probe]</b><br>Can be accessed if switch <b>SW2</b> on the control card is set to PTC. <ul style="list-style-type: none"> <li><input type="checkbox"/> <b>[No] (nO)</b>: Not used</li> <li><input type="checkbox"/> <b>[Always] (AS)</b>: "PTC probe" faults are monitored permanently, even if the power supply is not connected (as long as the control remains connected to the power supply).</li> <li><input type="checkbox"/> <b>[Power ON] (rdS)</b>: "PTC probe" faults are monitored while the drive power supply is connected.</li> <li><input type="checkbox"/> <b>[Motor ON] (rS)</b>: "PTC probe" faults are monitored while the motor power supply is connected.</li> </ul> |                  | <b>[No] (nO)</b> |
| <b>PTC1</b>  | <input type="checkbox"/> <b>[PTC1 probe]</b><br>Can be accessed if a VW3A3201 option card has been inserted. <ul style="list-style-type: none"> <li><input type="checkbox"/> <b>[No] (nO)</b>: Not used</li> <li><input type="checkbox"/> <b>[Always] (AS)</b>: "PTC probe" faults are monitored permanently, even if the power supply is not connected (as long as the control remains connected to the power supply).</li> <li><input type="checkbox"/> <b>[Power ON] (rdS)</b>: "PTC probe" faults are monitored while the drive power supply is connected.</li> <li><input type="checkbox"/> <b>[Motor ON] (rS)</b>: "PTC probe" faults are monitored while the motor power supply is connected.</li> </ul>                 |                  | <b>[No] (nO)</b> |
| <b>PTC2</b>  | <input type="checkbox"/> <b>[PTC2 probe]</b><br>Can be accessed if a VW3A3202 option card has been inserted. <ul style="list-style-type: none"> <li><input type="checkbox"/> <b>[No] (nO)</b>: Not used</li> <li><input type="checkbox"/> <b>[Always] (AS)</b>: "PTC probe" faults are monitored permanently, even if the power supply is not connected (as long as the control remains connected to the power supply).</li> <li><input type="checkbox"/> <b>[Power ON] (rdS)</b>: "PTC probe" faults are monitored while the drive power supply is connected.</li> <li><input type="checkbox"/> <b>[Motor ON] (rS)</b>: "PTC probe" faults are monitored while the motor power supply is connected.</li> </ul>                 |                  | <b>[No] (nO)</b> |



# [1.8 FAULT MANAGEMENT] (FLt-)

| Code           | Name/Description   | Adjustment range | Factory setting |
|----------------|--|------------------|-----------------|
| <b>r 5 t -</b> | <b>■ [FAULT RESET]</b>   |                  |                 |
| <b>r 5 F</b>   | <input type="checkbox"/> <b>[Fault reset]</b><br>Manual fault reset <ul style="list-style-type: none"> <li><input type="checkbox"/> <b>[No]</b> (nO): Function inactive</li> <li><input type="checkbox"/> <b>[LI1]</b> (LI1) to <b>[LI6]</b> (LI6)</li> <li><input type="checkbox"/> <b>[LI7]</b> (LI7) to <b>[LI10]</b> (LI10): If VW3A3201 logic I/O card has been inserted</li> <li><input type="checkbox"/> <b>[LI11]</b> (LI11) to <b>[LI14]</b> (LI14): If VW3A3202 extended I/O card has been inserted</li> <li><input type="checkbox"/> <b>[C101]</b> (C101) to <b>[C115]</b> (C115): With integrated Modbus in [I/O profile] (IO)</li> <li><input type="checkbox"/> <b>[C201]</b> (C201) to <b>[C215]</b> (C215): With integrated CANopen in [I/O profile] (IO)</li> <li><input type="checkbox"/> <b>[C301]</b> (C301) to <b>[C315]</b> (C315): With a communication card in [I/O profile] (IO)</li> <li><input type="checkbox"/> <b>[C401]</b> (C401) to <b>[C415]</b> (C415): With a Controller Inside card in [I/O profile] (IO)</li> <li><input type="checkbox"/> <b>[CD00]</b> (Cd00) to <b>[CD13]</b> (Cd13): In [I/O profile] (IO) can be switched with possible logic inputs</li> <li><input type="checkbox"/> <b>[CD14]</b> (Cd14) to <b>[CD15]</b> (Cd15): In [I/O profile] (IO) can be switched without logic inputs</li> </ul> Faults are reset when the assigned input or bit changes to 1, if the cause of the fault has disappeared. The STOP/RESET button on the graphic display terminal performs the same function. See pages 261 to 265 for a list of faults that can be reset manually. |                  | [No] (nO)       |
| <b>r P</b>     | <input type="checkbox"/> <b>[Product reset]</b><br>Parameter can only be accessed in [ACCESS LEVEL] = [Expert] mode.<br>Drive reinitialization. Can be used to reset all faults without having to disconnect the drive from the power supply. <ul style="list-style-type: none"> <li><input type="checkbox"/> <b>[No]</b> (nO): Function inactive</li> <li><input type="checkbox"/> <b>[Yes]</b> (YES): Reinitialization. Press and hold down the "ENT" key for 2 s. The parameter changes back to [No] (nO) automatically as soon as the operation is complete. The drive can only be reinitialized when locked.</li> </ul> <div style="border: 1px solid black; padding: 10px; text-align: center; margin: 10px 0;"> <p><b>CAUTION</b></p> <p>Make sure that the cause of the fault that led to the drive locking has been removed before reinitializing.<br/> <b>Failure to follow this instruction can result in equipment damage.</b></p> </div>  |                  | [No] (nO)       |
| <b>r P A</b>   | <input type="checkbox"/> <b>[Product reset assig.]</b><br>Parameter can only be modified in [ACCESS LEVEL] = [Expert] mode.<br>Drive reinitialization via logic input. Can be used to reset all faults without having to disconnect the drive from the power supply. The drive is reinitialized on a rising edge (change from 0 to 1) of the assigned input. The drive can only be reinitialized when locked. <ul style="list-style-type: none"> <li><input type="checkbox"/> <b>[No]</b> (nO): Function inactive</li> <li><input type="checkbox"/> <b>[LI1]</b> (LI1) to <b>[LI6]</b> (LI6)</li> <li><input type="checkbox"/> <b>[LI7]</b> (LI7) to <b>[LI10]</b> (LI10): If VW3A3201 logic I/O card has been inserted</li> <li><input type="checkbox"/> <b>[LI11]</b> (LI11) to <b>[LI14]</b> (LI14): If VW3A3202 extended I/O card has been inserted.</li> </ul> To assign reinitialization, press and hold down the "ENT" key for 2 s. <div style="border: 1px solid black; padding: 10px; text-align: center; margin: 10px 0;"> <p><b>CAUTION</b></p> <p>Make sure that the cause of the fault that led to the drive locking has been removed before reinitializing.<br/> <b>Failure to follow this instruction can result in equipment damage.</b></p> </div>  |                  | [No] (nO)       |

# [1.8 FAULT MANAGEMENT] (FLt-)

| Code  | Name/Description  | Adjustment range | Factory setting        |
|---|---|------------------|------------------------|
| <b>■ [AUTOMATIC RESTART]</b>  |   |                  |                        |
| <b>Atr</b><br><br><b>nO</b><br><b>YES</b>   | <input type="checkbox"/> <b>[Automatic restart]</b><br><br><input type="checkbox"/> <b>[No] (nO)</b> : Function inactive<br><input type="checkbox"/> <b>[Yes] (YES)</b> : Automatic restart, after locking on a fault, if the fault has disappeared and the other operating conditions permit the restart. The restart is performed by a series of automatic attempts separated by increasingly longer waiting periods: 1 s, 5 s, 10 s, then 1 minute for the following attempts. The drive fault relay remains activated if this function is active. The speed reference and the operating direction must be maintained.<br>Use 2-wire control ( <b>[2/3 wire control] (tCC) = [2 wire] (2C)</b> and <b>[2 wire type] (tCt) = [Level] (LEL)</b> see page <a href="#">86</a> ). |                  | <b>[No] (nO)</b>       |
| <div style="border: 1px solid black; padding: 5px; margin: 10px auto; width: 80%;"> <div style="text-align: center; font-weight: bold; font-size: 1.2em;">  <b>WARNING</b> </div> <div style="text-align: center; font-weight: bold; margin-top: 5px;"> <b>UNINTENDED EQUIPMENT OPERATION</b> </div> <p style="text-align: center; margin: 5px 0;">Check that an automatic restart will not endanger personnel or equipment in any way.</p> <p style="text-align: center; margin: 5px 0;">Failure to follow these instructions can result in death or serious injury.</p> </div> |   |                  |                        |
| <b>tAr</b><br><br><b>5</b><br><b>10</b><br><b>30</b><br><b>1h</b><br><b>2h</b><br><b>3h</b><br><b>Ct</b>  | <input type="checkbox"/> <b>[Max. restart time]</b><br><br><input type="checkbox"/> <b>[5 min] (5)</b> : 5 minutes<br><input type="checkbox"/> <b>[10 minutes] (10)</b> : 10 minutes<br><input type="checkbox"/> <b>[30 minutes] (30)</b> : 30 minutes<br><input type="checkbox"/> <b>[1 hour] (1h)</b> : 1 hour<br><input type="checkbox"/> <b>[2 hours] (2h)</b> : 2 hours<br><input type="checkbox"/> <b>[3 hours] (3h)</b> : 3 hours<br><input type="checkbox"/> <b>[Unlimited] (Ct)</b> : Unlimited<br>This parameter appears if <b>[Automatic restart] (Atr) = [Yes] (YES)</b> . It can be used to limit the number of consecutive restarts on a recurrent fault.   |                  | <b>[5 minutes] (5)</b> |
| <p>If the restart has not taken place once the configurable time tAr has elapsed, the procedure is aborted and the drive remains locked until it is turned off and then on again.<br/>                     The faults, which permit this function, are listed on page <a href="#">264</a>:</p>  |   |                  |                        |

## [1.8 FAULT MANAGEMENT] (FLt-)

| Code  | Name/Description  | Adjustment range | Factory setting |
|---|---|------------------|-----------------|
| <b>FLr-</b>   | <div style="background-color: #00FFFF; padding: 5px;">  <b>Note:</b> This function cannot be used with certain other functions. Follow the instructions on page <a href="#">127</a>.                 </div>  |                  |                 |
| <b>FLr</b>  | <input type="checkbox"/> <b>[Catch on the fly]</b>  |                  | [No] (nO)       |
| nO<br>YES   | <p>Used to enable a smooth restart if the run command is maintained after the following events:</p> <ul style="list-style-type: none"> <li>• Loss of line supply or disconnection</li> <li>• Reset of current fault or automatic restart</li> <li>• Freewheel stop.</li> </ul> <p>The speed given by the drive resumes from the estimated speed of the motor at the time of the restart, then follows the ramp to the reference speed.<br/>This function requires 2-wire level control.</p> <p><input type="checkbox"/> <b>[No] (nO):</b> Function inactive<br/> <input type="checkbox"/> <b>[Yes] (YES):</b> Function active</p> <p>When the function is operational, it activates at each run command, resulting in a slight delay of the current (0.5 s max.).<br/> <b>[Catch on the fly] (FLr)</b> is forced to <b>[No] (nO)</b> if the braking command <b>[Brake assignment] (bLC)</b> is assigned (page <a href="#">157</a>) or if, in open-loop control, <b>[Auto DC injection] (AdC)</b> page <a href="#">139</a> = <b>[Continuous] (Ct)</b>.</p> |                  |                 |
| <b>UCb</b><br> | <input type="checkbox"/> <b>[Sensitivity]</b>   | 0.4 to 15%       | 0.6%            |
|   | <p>The parameter can be accessed at and above 55 kW (75 HP) for the ATV71●●●M3X and at and above 90 kW (120 HP) for the ATV71●●●N4.<br/>           Adjusts the catch-on-the-fly sensitivity around the zero speed.<br/>           Decrease the value if the drive is not able to perform the catch on the fly, and increase it if the drive locks on a fault as it performs the catch on the fly.</p>   |                  |                 |

 Parameter that can be modified during operation or when stopped.

## [1.8 FAULT MANAGEMENT] (FLt-)

### Motor thermal protection

#### Function:

Thermal protection by calculating the  $I^2t$ .

 **Note:** The memory of the motor thermal state is saved when the drive is switched off. The power-off time is used to recalculate the thermal state the next time the drive is switched on.

- Naturally-cooled motors:  
The tripping curves depend on the motor frequency.
- Force-cooled motors:  
Only the 50 Hz tripping curve needs to be considered, regardless of the motor frequency.

Trip time in seconds

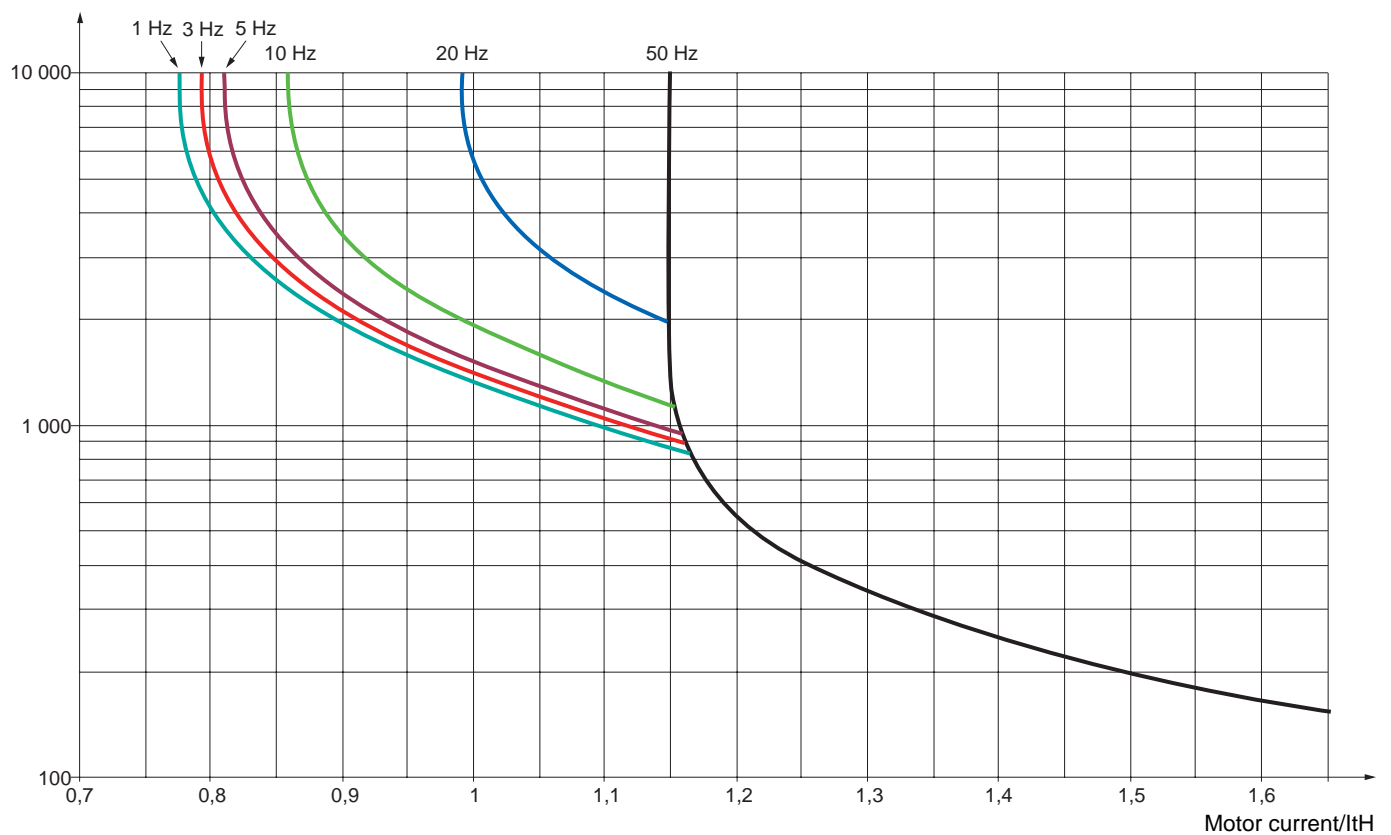



## [1.8 FAULT MANAGEMENT] (FLt-)

| Code   | Name/Description  | Adjustment range | Factory setting     |
|--|---|------------------|---------------------|
| <b>EHL -</b>   | <b>■ [MOTOR THERMAL PROT.]</b>  |                  |                     |
| <b>EHE</b><br>nO<br>ACL<br>FCL   | <input type="checkbox"/> <b>[Motor protect. type]</b><br><input type="checkbox"/> <b>[No]</b> (nO): No protection.<br><input type="checkbox"/> <b>[Self cooled]</b> (ACL): For self-cooled motors<br><input type="checkbox"/> <b>[Force-cool]</b> (FCL): For force-cooled motors<br><b>Note:</b> A fault trip will occur when the thermal state reaches 118% of the rated state and reactivation will occur when the state falls back below 100%.   |                  | [Self cooled] (ACL) |
| <b>EEd</b><br>( )  | <input type="checkbox"/> <b>[Motor therm. level]</b> (1)<br>Trip threshold for motor thermal alarm (logic output or relay)  | 0 to 118%        | 100%                |
| <b>EEd2</b><br>( )   | <input type="checkbox"/> <b>[Motor2 therm. level]</b><br>Trip threshold for motor 2 thermal alarm (logic output or relay)   | 0 to 118%        | 100%                |
| <b>EEd3</b><br>( )   | <input type="checkbox"/> <b>[Motor3 therm. level]</b><br>Trip threshold for motor 3 thermal alarm (logic output or relay)   | 0 to 118%        | 100%                |
| <b>OLL</b><br>nO<br>YES<br>SEt<br><br>LFF<br>rLS<br><br>rNP<br>FSSt<br>dCI | <input type="checkbox"/> <b>[Overload fault mgt]</b><br>Type of stop in the event of a motor thermal fault.<br><input type="checkbox"/> <b>[Ignore]</b> (nO): Fault ignored.<br><input type="checkbox"/> <b>[Freewheel]</b> (YES): Freewheel stop.<br><input type="checkbox"/> <b>[Per STT]</b> (Stt): Stop according to configuration of <b>[Type of stop]</b> (Stt) page 137, without fault tripping. In this case the fault relay does not open and the drive is ready to restart as soon as the fault disappears, according to the restart conditions of the active command channel (e.g., according to <b>[2/3 wire control]</b> (tCC) and <b>[2 wire type]</b> (tCt) page 86 if control is via the terminals). Configuring an alarm for this fault is recommended (assigned to a logic output, for example) in order to indicate the cause of the stop.<br><input type="checkbox"/> <b>[fallback spd]</b> (LFF): Change to fallback speed, maintained as long as the fault persists and the run command has not been removed (2).<br><input type="checkbox"/> <b>[Spd maint.]</b> (rLS): The drive maintains the speed being applied when the fault occurred, as long as the fault is present and the run command has not been removed (2).<br><input type="checkbox"/> <b>[Ramp stop]</b> (rNP): Stop on ramp.<br><input type="checkbox"/> <b>[Fast stop]</b> (FSSt): Fast stop.<br><input type="checkbox"/> <b>[DC injection]</b> (dCI): DC injection stop. This type of stop cannot be used with certain other functions. See table on page 127. |                  | [Freewheel] (YES)   |
| <b>OPL -</b>   | <b>■ [OUTPUT PHASE LOSS]</b>  |                  |                     |
| <b>OPL</b><br>nO<br>YES<br>OAC   | <input type="checkbox"/> <b>[Output Phase Loss]</b><br><input type="checkbox"/> <b>[No]</b> (nO): Function inactive<br><input type="checkbox"/> <b>[Yes]</b> (YES): Tripping on OPF fault with freewheel stop.<br><input type="checkbox"/> <b>[Output cut]</b> (OAC): No fault triggered, but management of the output voltage in order to avoid an overcurrent when the link with the motor is re-established and catch on the fly performed (even if this function has not been configured).<br><br><b>Note:</b> <b>[Output Phase Loss]</b> (OPL) is forced to <b>[Yes]</b> (YES) if brake logic control is configured (see page 157).  |                  | [Yes] (YES)         |
| <b>OdE</b><br>( )  | <input type="checkbox"/> <b>[OutPh time detect]</b><br>Time delay for taking the <b>[Output Phase Loss]</b> (OPL) fault into account.   | 0.5 to 10 s      | 0.5 s               |

(1) The parameter can also be accessed in the **[1.3 SETTINGS] (SEt-)** menu.

(2) Because, in this case, the fault does not trigger a stop, it is essential to assign a relay or logic output to its indication.

**( )** Parameter that can be modified during operation or when stopped.

## [1.8 FAULT MANAGEMENT] (FLt-)

| IPL -  | ■ [INPUT PHASE LOSS]   |  |      |
|--|--|--|------|
| IPL<br>nO<br>YES   | <input type="checkbox"/> [Input phase loss] <ul style="list-style-type: none"> <li><input type="checkbox"/> [Ignore] (nO): Fault ignored, to be used when the drive is supplied via a single phase supply or by the DC bus.</li> <li><input type="checkbox"/> [Freewheel] (YES): Fault with freewheel stop.<br/>If one phase disappears, the drive switches to fault mode [Input phase loss] (IPL) but if 2 or 3 phases disappear, the drive continues to operate until it trips on an undervoltage fault.</li> </ul> Factory setting: [Ignore] (nO) for ATV71●037M3 to U30M3, [Freewheel] (YES) for all others.   | According to drive rating                  |      |
| OHL -  | ■ [DRIVE OVERHEAT]   |  |      |
| OHL<br>nO<br>YES<br>Stt<br>LFF<br>rLS<br>rMP<br>FSt<br>dCI | <input type="checkbox"/> [Overtemp fault mgt] <p>Behavior in the event of the drive overheating</p> <ul style="list-style-type: none"> <li><input type="checkbox"/> [Ignore] (nO): Fault ignored.</li> <li><input type="checkbox"/> [Freewheel] (YES): Freewheel stop.</li> <li><input type="checkbox"/> [Per STT] (Stt): Stop according to configuration of [Type of stop] (Stt) page 137, without fault tripping. In this case the fault relay does not open and the drive is ready to restart as soon as the fault disappears, according to the restart conditions of the active command channel (e.g., according to [2/3 wire control] (tCC) and [2 wire type] (tCt) page 86 if control is via the terminals). Configuring an alarm for this fault is recommended (assigned to a logic output, for example) in order to indicate the cause of the stop.</li> <li><input type="checkbox"/> [fallback spd] (LFF): Change to fallback speed, maintained as long as the fault persists and the run command has not been removed (1).</li> <li><input type="checkbox"/> [Spd maint.] (rLS): The drive maintains the speed being applied when the fault occurred, as long as the fault is present and the run command has not been removed (1).</li> <li><input type="checkbox"/> [Ramp stop] (rMP): Stop on ramp.</li> <li><input type="checkbox"/> [Fast stop] (FSt): Fast stop.</li> <li><input type="checkbox"/> [DC injection] (dCI): DC injection stop. This type of stop cannot be used with certain other functions. See table on page 127.</li> </ul> <p><b>Note:</b> A fault trip will occur when the thermal state reaches 118% of the rated state and reactivation will occur when the state falls back below 90%.</p> | <input type="checkbox"/> [Freewheel] (YES) |      |
| LHA<br>( )   | <input type="checkbox"/> [Drv therm. state al] <p>Trip threshold for drive thermal alarm (logic output or relay)</p>   | 0 to 118%                                  | 100% |

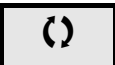
 Parameter that can be modified during operation or when stopped.

(1) Because, in this case, the fault does not trigger a stop, it is essential to assign a relay or logic output to its indication.

## [1.8 FAULT MANAGEMENT] (FLt-)

### Deferred stop on thermal alarm

This function is designed in particular for elevator applications. It prevents the elevator stopping between two floors if the drive or motor overheats, by authorizing operation until the next stop. At the next stop, the drive is locked until the thermal state falls back to a value, which undershoots the set threshold by 20%. Example: A trip threshold set at 80% enables reactivation at 60%. One thermal state threshold must be defined for the drive, and one thermal state threshold for the motor(s), which will trip the deferred stop.

| Code   | Name/Description  | Adjustment range | Factory setting  |
|--|---|------------------|------------------|
| <b>SAL-</b>  | <b>[THERMAL ALARM STOP]</b>   |                  |                  |
| <b>SAL</b><br>nO<br>YES  | <input type="checkbox"/> <b>[Thermal alarm stop]</b><br><input type="checkbox"/> <b>[No] (nO)</b> : Function inactive (in this case, the following parameters cannot be accessed)<br><input type="checkbox"/> <b>[Yes] (YES)</b> : Freewheel stop on drive or motor thermal alarm |                  | <b>[No] (nO)</b> |
| <b>CAUTION</b><br>The drive and motor are no longer protected in the event of thermal alarm stops. This invalidates the warranty.<br>Check that the possible consequences do not present any risk.<br>Failure to follow this instruction can result in equipment damage. |   |                  |                  |
| <b>LHA</b><br>( )  | <input type="checkbox"/> <b>[Drv therm. state al]</b><br>Thermal state threshold of the drive tripping the deferred stop.   | 0 to 118%        | 100%             |
| <b>Ltd</b><br>( )  | <input type="checkbox"/> <b>[Motor therm. level]</b><br>Thermal state threshold of the motor tripping the deferred stop.  | 0 to 118%        | 100%             |
| <b>Ltd2</b><br>( )   | <input type="checkbox"/> <b>[Motor2 therm. level]</b><br>Thermal state threshold of the motor 2 tripping the deferred stop.   | 0 to 118%        | 100%             |
| <b>Ltd3</b><br>( )   | <input type="checkbox"/> <b>[Motor3 therm. level]</b><br>Thermal state threshold of the motor 3 tripping the deferred stop.   | 0 to 118%        | 100%             |

 Parameter that can be modified during operation or when stopped.

## [1.8 FAULT MANAGEMENT] (FLt-)

| Code   | Name/Description   | Adjustment range | Factory setting            |
|--|--|------------------|----------------------------|
| <b>E L F -</b>   | <b>■ [EXTERNAL FAULT]</b>  |                  |                            |
| <b>E E F</b><br>n O<br>L I I<br>-<br>-<br>-  | <input type="checkbox"/> <b>[External fault ass.]</b><br><input type="checkbox"/> <b>[No] (nO)</b> : Function inactive<br><input type="checkbox"/> <b>[LI1] (LI1)</b><br>...<br><input type="checkbox"/> <b>[...] (...)</b> : See the assignment conditions on page 121.<br>If the assigned bit is at 0, there is no external fault.<br>If the assigned bit is at 1, there is an external fault.<br>Logic can be configured via <a href="#">[External fault config] (LEt)</a> if a logic input has been assigned.  |                  | <b>[No] (nO)</b>           |
| <b>L E E</b><br>L O<br>H I G   | <input type="checkbox"/> <b>[External fault config]</b><br>Parameter can be accessed if the external fault has been assigned to a logic input. It defines the positive or negative logic of the input assigned to the fault.<br><input type="checkbox"/> <b>[Active low] (LO)</b> : Fault on falling edge (change from 1 to 0) of the assigned input.<br><input type="checkbox"/> <b>[Active high] (HIG)</b> : Fault on rising edge (change from 0 to 1) of the assigned input.  |                  | <b>[Active high] (HIG)</b> |
| <b>E P L</b><br>n O<br>Y E S<br>S E E<br><br>L F F<br>r L S<br>r P P<br>F S E<br>d C I | <input type="checkbox"/> <b>[External fault mgt]</b><br>Type of stop in the event of an external fault<br><input type="checkbox"/> <b>[Ignore] (nO)</b> : Fault ignored.<br><input type="checkbox"/> <b>[Freewheel] (YES)</b> : Freewheel stop.<br><input type="checkbox"/> <b>[Per STT] (Stt)</b> : Stop according to configuration of <a href="#">[Type of stop] (Stt)</a> page 137, without fault tripping. In this case the fault relay does not open and the drive is ready to restart as soon as the fault disappears, according to the restart conditions of the active command channel (e.g., according to <a href="#">[2/3 wire control] (tCC)</a> and <a href="#">[2 wire type] (tCt)</a> page 86 if control is via the terminals). Configuring an alarm for this fault is recommended (assigned to a logic output, for example) in order to indicate the cause of the stop.<br><input type="checkbox"/> <b>[fallback spd] (LFF)</b> : Change to fallback speed, maintained as long as the fault persists and the run command has not been removed (1).<br><input type="checkbox"/> <b>[Spd maint.] (rLS)</b> : The drive maintains the speed being applied when the fault occurred, as long as the fault is present and the run command has not been removed (1).<br><input type="checkbox"/> <b>[Ramp stop] (rMP)</b> : Stop on ramp.<br><input type="checkbox"/> <b>[Fast stop] (FSt)</b> : Fast stop.<br><input type="checkbox"/> <b>[DC injection] (dCI)</b> : DC injection stop. This type of stop cannot be used with certain other functions. See table on page 127. |                  | <b>[Freewheel] (YES)</b>   |

(1) Because, in this case, the fault does not trigger a stop, it is essential to assign a relay or logic output to its indication.

# [1.8 FAULT MANAGEMENT] (FLt-)

| Code               | Name/Description  | Adjustment range                  | Factory setting                   |
|--------------------|---|-----------------------------------|-----------------------------------|
| <b>USb -</b>       | <b>■ [UNDERVOLTAGE MGT]</b>   |                                   |                                   |
| <b>USb</b>         | <input type="checkbox"/> <b>[UnderV. fault mgt]</b><br>Behavior of the drive in the event of an undervoltage<br><input type="checkbox"/> <b>[Fit&amp;R1open]</b> (0): Fault and fault relay open.<br><input type="checkbox"/> <b>[Fit&amp;R1close]</b> (1): Fault and fault relay closed.<br><input type="checkbox"/> <b>[Alarm]</b> (2): Alarm and fault relay remains closed. The alarm can be assigned to a logic output or a relay.   |                                   | [Fit&R1open] (0)                  |
| <b>UrES</b>        | <input type="checkbox"/> <b>[Mains voltage]</b><br>Rated voltage of the line supply in V.<br>For ATV71ATV71●●●M3:<br><input type="checkbox"/> <b>[200V ac]</b> (200): 200 Volts AC<br><input type="checkbox"/> <b>[220V ac]</b> (220): 220 Volts AC<br><input type="checkbox"/> <b>[240V ac]</b> (240): 240 Volts AC<br><input type="checkbox"/> <b>[260V ac]</b> (260): 260 Volts AC (factory setting)<br>For ATV71●●●N4:<br><input type="checkbox"/> <b>[380V ac]</b> (380): 380 Volts AC<br><input type="checkbox"/> <b>[400V ac]</b> (400): 400 Volts AC<br><input type="checkbox"/> <b>[440V ac]</b> (440): 440 Volts AC<br><input type="checkbox"/> <b>[460V ac]</b> (460): 460 Volts AC<br><input type="checkbox"/> <b>[480V ac]</b> (480): 480 Volts AC (factory setting) | According to drive voltage rating | According to drive voltage rating |
| <b>USL</b>         | <input type="checkbox"/> <b>[Undervoltage level]</b><br>Undervoltage fault trip level setting in V. The adjustment range and factory setting are determined by the drive voltage rating and the <b>[Mains voltage] (UrES) value</b> .   |                                   |                                   |
| <b>USL</b>         | <input type="checkbox"/> <b>[Undervolt. time out]</b><br>Time delay for taking undervoltage fault into account  | 0.2 s to 999.9 s                  | 0.2 s                             |
| <b>StP</b>         | <input type="checkbox"/> <b>[UnderV. prevention]</b><br>Behavior in the event of the undervoltage fault prevention level being reached<br><input type="checkbox"/> <b>[No] (nO)</b> : No action<br><input type="checkbox"/> <b>[DC Maintain] (MMS)</b> : This stop mode uses the inertia to maintain the DC bus voltage as long as possible.<br><input type="checkbox"/> <b>[Ramp stop] (rMP)</b> : Stop following an adjustable ramp <b>[Max stop time] (StM)</b> .<br><input type="checkbox"/> <b>[Lock-out] (LnF)</b> : Lock (freewheel stop) without fault  |                                   | [No] (nO)                         |
| <b>EstP</b>        | <input type="checkbox"/> <b>[UnderV. restart tm]</b><br>Time delay before authorizing the restart after a complete stop for <b>[UnderV. prevention] (StP) = [Ramp stop] (rMP)</b> , if the voltage has returned to normal.  | 1.0 s to 999.9 s                  | 1.0 s                             |
| <b>UPL</b>         | <input type="checkbox"/> <b>[Prevention level]</b><br>Undervoltage fault prevention level setting in V, which can be accessed if <b>[UnderV. prevention] (StP)</b> is not <b>[No] (nO)</b> . The adjustment range and factory setting are determined by the drive voltage rating and the <b>[Mains voltage] (UrES) value</b> .  |                                   |                                   |
| <b>StP</b><br>( )  | <input type="checkbox"/> <b>[Max stop time]</b><br>Ramp time if <b>[UnderV. prevention] (StP) = [Ramp stop] (rMP)</b> .   | 0.01 to 60.00 s                   | 1.00 s                            |
| <b>EstP</b><br>( ) | <input type="checkbox"/> <b>[DC bus maintain tm]</b><br>DC bus maintain time if <b>[UnderV. prevention] (StP) = [DC Maintain] (MMS)</b> .   | 1 to 9999 s                       | 9999 s                            |

( ) Parameter that can be modified during operation or when stopped.

## [1.8 FAULT MANAGEMENT] (FLt-)

| Code              | Name/Description   | Adjustment range | Factory setting                           |
|-------------------|--|------------------|---|
| FLt-              | <b>[IGBT TESTS]</b>  |                  |   |
| FLt-<br>n0<br>YES | <input type="checkbox"/> <b>[IGBT test]</b><br><input type="checkbox"/> <b>[No] (n0)</b> : No test<br><input type="checkbox"/> <b>[Yes] (YES)</b> : The IGBTs are tested on power up and every time a run command is sent. These tests cause a slight delay (a few ms). In the event of a fault, the drive will lock. The following faults can be detected: <ul style="list-style-type: none"><li>- Drive output short-circuit (terminals U-V-W): SCF display</li><li>- IGBT faulty: xtF, where x indicates the number of the IGBT concerned</li><li>- IGBT short-circuited: x2F, where x indicates the number of the IGBT concerned</li></ul> |                  | <input type="checkbox"/> <b>[No] (n0)</b> |

## [1.8 FAULT MANAGEMENT] (FLt-)

| Code         | Name/Description  | Adjustment range | Factory setting |
|--------------|---|------------------|-----------------|
| <b>LFL -</b> | <b>■ [4-20mA LOSS]</b>  |                  |                 |
| <b>LFL2</b>  | <input type="checkbox"/> <b>[AI2 4-20mA loss]</b>   |                  | [Ignore] (nO)   |
| nO           | <input type="checkbox"/> <b>[Ignore] (nO)</b> : Fault ignored. This configuration is the only one possible if [AI2 min. value] (CrL2) page 92 is not greater than 3 mA or if [AI2 Type] (AI2t) page 92 = [Voltage] (10U).   |                  |                 |
| YES          | <input type="checkbox"/> <b>[Freewheel] (YES)</b> : Freewheel stop.   |                  |                 |
| SEt          | <input type="checkbox"/> <b>[Per STT] (Stt)</b> : Stop according to configuration of [Type of stop] (Stt) page 137, without fault tripping. In this case the fault relay does not open and the drive is ready to restart as soon as the fault disappears, according to the restart conditions of the active command channel (e.g., according to [2/3 wire control] (tCC) and [2 wire type] (tCt) page 86 if control is via the terminals). Configuring an alarm for this fault is recommended (assigned to a logic output, for example) in order to indicate the cause of the stop. |                  |                 |
| LFF          | <input type="checkbox"/> <b>[fallback spd] (LFF)</b> : Change to fallback speed, maintained as long as the fault persists and the run command has not been removed (1).   |                  |                 |
| rLS          | <input type="checkbox"/> <b>[Spd maint.] (rLS)</b> : The drive maintains the speed being applied when the fault occurred, as long as the fault is present and the run command has not been removed (1).   |                  |                 |
| rNP          | <input type="checkbox"/> <b>[Ramp stop] (rMP)</b> : Stop on ramp.   |                  |                 |
| FSt          | <input type="checkbox"/> <b>[Fast stop] (FSt)</b> : Fast stop.  |                  |                 |
| dCI          | <input type="checkbox"/> <b>[DC injection] (dCI)</b> : DC injection stop. This type of stop cannot be used with certain other functions. See table on page 127.   |                  |                 |
| <b>LFL3</b>  | <input type="checkbox"/> <b>[AI3 4-20mA loss]</b>   |                  | [Ignore] (nO)   |
| nO           | <input type="checkbox"/> <b>[Ignore] (nO)</b> : Fault ignored. This configuration is the only one possible if [AI3 min. value] (CrL3) page 93 is not greater than 3 mA.   |                  |                 |
| YES          | <input type="checkbox"/> <b>[Freewheel] (YES)</b> : Freewheel stop.   |                  |                 |
| SEt          | <input type="checkbox"/> <b>[Per STT] (Stt)</b> : Stop according to configuration of [Type of stop] (Stt) page 137, without fault tripping. In this case the fault relay does not open and the drive is ready to restart as soon as the fault disappears, according to the restart conditions of the active command channel (e.g., according to [2/3 wire control] (tCC) and [2 wire type] (tCt) page 86 if control is via the terminals). Configuring an alarm for this fault is recommended (assigned to a logic output, for example) in order to indicate the cause of the stop. |                  |                 |
| LFF          | <input type="checkbox"/> <b>[fallback spd] (LFF)</b> : Change to fallback speed, maintained as long as the fault persists and the run command has not been removed (1).   |                  |                 |
| rLS          | <input type="checkbox"/> <b>[Spd maint.] (rLS)</b> : The drive maintains the speed being applied when the fault occurred, as long as the fault is present and the run command has not been removed (1).   |                  |                 |
| rNP          | <input type="checkbox"/> <b>[Ramp stop] (rMP)</b> : Stop on ramp.   |                  |                 |
| FSt          | <input type="checkbox"/> <b>[Fast stop] (FSt)</b> : Fast stop.  |                  |                 |
| dCI          | <input type="checkbox"/> <b>[DC injection] (dCI)</b> : DC injection stop. This type of stop cannot be used with certain other functions. See table on page 127.   |                  |                 |
| <b>LFL4</b>  | <input type="checkbox"/> <b>[AI4 4-20mA loss]</b>   |                  | [Ignore] (nO)   |
| nO           | <input type="checkbox"/> <b>[Ignore] (nO)</b> : Fault ignored. This configuration is the only one possible if [AI4 min. value] (CrL4) page 94 is not greater than 3 mA or if [AI4 Type] (AI4t) page 94 = [Voltage] (10U).   |                  |                 |
| YES          | <input type="checkbox"/> <b>[Freewheel] (YES)</b> : Freewheel stop.   |                  |                 |
| SEt          | <input type="checkbox"/> <b>[Per STT] (Stt)</b> : Stop according to configuration of [Type of stop] (Stt) page 137, without fault tripping. In this case the fault relay does not open and the drive is ready to restart as soon as the fault disappears, according to the restart conditions of the active command channel (e.g., according to [2/3 wire control] (tCC) and [2 wire type] (tCt) page 86 if control is via the terminals). Configuring an alarm for this fault is recommended (assigned to a logic output, for example) in order to indicate the cause of the stop. |                  |                 |
| LFF          | <input type="checkbox"/> <b>[fallback spd] (LFF)</b> : Change to fallback speed, maintained as long as the fault persists and the run command has not been removed (1).   |                  |                 |
| rLS          | <input type="checkbox"/> <b>[Spd maint.] (rLS)</b> : The drive maintains the speed being applied when the fault occurred, as long as the fault is present and the run command has not been removed (1).   |                  |                 |
| rNP          | <input type="checkbox"/> <b>[Ramp stop] (rMP)</b> : Stop on ramp.   |                  |                 |
| FSt          | <input type="checkbox"/> <b>[Fast stop] (FSt)</b> : Fast stop.  |                  |                 |
| dCI          | <input type="checkbox"/> <b>[DC injection] (dCI)</b> : DC injection stop. This type of stop cannot be used with certain other functions. See table on page 127.   |                  |                 |

(1) Because, in this case, the fault does not trigger a stop, it is essential to assign a relay or logic output to its indication.

## [1.8 FAULT MANAGEMENT] (FLt-)

Parameter can be accessed in [Expert] mode.

| Code                       | Name/Description   | Adjustment range | Factory setting |
|----------------------------|--|------------------|-----------------|
| InH -                      | <div style="background-color: #00FFFF; padding: 5px;"> <b>■ [FAULT INHIBITION]</b> </div>  |                  |                 |
| InH                        | <input type="checkbox"/> <b>[Fault inhibit assign.]</b>  |                  | [No] (nO)       |
|                            | <p>To assign fault inhibit, press and hold down the "ENT" key for 2 s.</p>   |                  |                 |
|                            | <div style="border: 1px solid black; padding: 10px; background-color: #FFFF00;"> <h3>CAUTION</h3> <p><b>Inhibiting faults results in the drive not being protected. This invalidates the warranty. Check that the possible consequences do not present any risk. Failure to follow this instruction can result in equipment damage.</b></p> </div>   |                  |                 |
| nO<br>L I I<br>-<br>-<br>- | <input type="checkbox"/> <b>[No] (nO)</b> : Function inactive<br><input type="checkbox"/> <b>[LI1] (LI1)</b><br>:<br>:<br><input type="checkbox"/> <b>[...] (...)</b> : See the assignment conditions on page <a href="#">121</a> .<br>If the assigned input or bit is at 0, fault monitoring is active. If the assigned input or bit is at 1, fault monitoring is inactive. Active faults are reset on a rising edge (change from 0 to 1) of the assigned input or bit. |                  |                 |
|                            | <p><b>Note:</b> The "Power Removal" function and any faults that prevent any form of operation are not affected by this function.<br/>           A list of faults affected by this function appears on pages <a href="#">261</a> to <a href="#">266</a>.</p>   |                  |                 |



## [1.8 FAULT MANAGEMENT] (FLt-)

| Code                                   | Name/Description  | Adjustment range | Factory setting          |
|--|---|------------------|--------------------------|
| <b>CLL -</b>                           | <b>■ [COM. FAULT MANAGEMENT]</b>  |                  |                          |
| <b>CLL</b>                             | <input type="checkbox"/> <b>[Network fault mgt]</b>   |                  | <b>[Freewheel] (YES)</b> |
| <i>nO</i><br><i>YES</i><br><i>Stt</i>  | <p>Behavior of the drive in the event of a communication fault with a communication card</p> <ul style="list-style-type: none"> <li><input type="checkbox"/> <b>[Ignore] (nO)</b>: Fault ignored.</li> <li><input type="checkbox"/> <b>[Freewheel] (YES)</b>: Freewheel stop.</li> <li><input type="checkbox"/> <b>[Per STT] (Stt)</b>: Stop according to configuration of <b>[Type of stop] (Stt)</b> page 137, without fault tripping. In this case the fault relay does not open and the drive is ready to restart as soon as the fault disappears, according to the restart conditions of the active command channel (e.g., according to <b>[2/3 wire control] (tCC)</b> and <b>[2 wire type] (tCt)</b> page 86 if control is via the terminals). Configuring an alarm for this fault is recommended (assigned to a logic output, for example) in order to indicate the cause of the stop.</li> </ul> |                  |                          |
| <i>LFF</i>                             | <input type="checkbox"/> <b>[fallback spd] (LFF)</b> : Change to fallback speed, maintained as long as the fault persists and the run command has not been removed (1).   |                  |                          |
| <i>rLS</i>                             | <input type="checkbox"/> <b>[Spd maint.] (rLS)</b> : The drive maintains the speed being applied when the fault occurred, as long as the fault is present and the run command has not been removed (1).   |                  |                          |
| <i>rMP</i><br><i>FSt</i><br><i>dCI</i> | <ul style="list-style-type: none"> <li><input type="checkbox"/> <b>[Ramp stop] (rMP)</b>: Stop on ramp.</li> <li><input type="checkbox"/> <b>[Fast stop] (FSt)</b>: Fast stop.</li> <li><input type="checkbox"/> <b>[DC injection] (dCI)</b>: DC injection stop. This type of stop cannot be used with certain other functions. See table on page 127.</li> </ul>   |                  |                          |
| <b>COL</b>                             | <input type="checkbox"/> <b>[CANopen fault mgt]</b>   |                  | <b>[Freewheel] (YES)</b> |
| <i>nO</i><br><i>YES</i><br><i>Stt</i>  | <p>Behavior of the drive in the event of a communication fault with integrated CANopen</p> <ul style="list-style-type: none"> <li><input type="checkbox"/> <b>[Ignore] (nO)</b>: Fault ignored.</li> <li><input type="checkbox"/> <b>[Freewheel] (YES)</b>: Freewheel stop.</li> <li><input type="checkbox"/> <b>[Per STT] (Stt)</b>: Stop according to configuration of <b>[Type of stop] (Stt)</b> page 137, without fault tripping. In this case the fault relay does not open and the drive is ready to restart as soon as the fault disappears, according to the restart conditions of the active command channel (e.g., according to <b>[2/3 wire control] (tCC)</b> and <b>[2 wire type] (tCt)</b> page 86 if control is via the terminals). Configuring an alarm for this fault is recommended (assigned to a logic output, for example) in order to indicate the cause of the stop.</li> </ul>   |                  |                          |
| <i>LFF</i>                             | <input type="checkbox"/> <b>[fallback spd] (LFF)</b> : Change to fallback speed, maintained as long as the fault persists and the run command has not been removed (1).   |                  |                          |
| <i>rLS</i>                             | <input type="checkbox"/> <b>[Spd maint.] (rLS)</b> : The drive maintains the speed being applied when the fault occurred, as long as the fault is present and the run command has not been removed (1).   |                  |                          |
| <i>rMP</i><br><i>FSt</i><br><i>dCI</i> | <ul style="list-style-type: none"> <li><input type="checkbox"/> <b>[Ramp stop] (rMP)</b>: Stop on ramp.</li> <li><input type="checkbox"/> <b>[Fast stop] (FSt)</b>: Fast stop.</li> <li><input type="checkbox"/> <b>[DC injection] (dCI)</b>: DC injection stop. This type of stop cannot be used with certain other functions. See table on page 127.</li> </ul>   |                  |                          |
| <b>SLL</b>                             | <input type="checkbox"/> <b>[Modbus fault mgt]</b>  |                  | <b>[Freewheel] (YES)</b> |
| <i>nO</i><br><i>YES</i><br><i>Stt</i>  | <p>Behavior of the drive in the event of a communication fault with integrated Modbus</p> <ul style="list-style-type: none"> <li><input type="checkbox"/> <b>[Ignore] (nO)</b>: Fault ignored.</li> <li><input type="checkbox"/> <b>[Freewheel] (YES)</b>: Freewheel stop.</li> <li><input type="checkbox"/> <b>[Per STT] (Stt)</b>: Stop according to configuration of <b>[Type of stop] (Stt)</b> page 137, without fault tripping. In this case the fault relay does not open and the drive is ready to restart as soon as the fault disappears, according to the restart conditions of the active command channel (e.g., according to <b>[2/3 wire control] (tCC)</b> and <b>[2 wire type] (tCt)</b> page 86 if control is via the terminals). Configuring an alarm for this fault is recommended (assigned to a logic output, for example) in order to indicate the cause of the stop.</li> </ul>    |                  |                          |
| <i>LFF</i>                             | <input type="checkbox"/> <b>[fallback spd] (LFF)</b> : Change to fallback speed, maintained as long as the fault persists and the run command has not been removed (1).   |                  |                          |
| <i>rLS</i>                             | <input type="checkbox"/> <b>[Spd maint.] (rLS)</b> : The drive maintains the speed being applied when the fault occurred, as long as the fault is present and the run command has not been removed (1).   |                  |                          |
| <i>rMP</i><br><i>FSt</i><br><i>dCI</i> | <ul style="list-style-type: none"> <li><input type="checkbox"/> <b>[Ramp stop] (rMP)</b>: Stop on ramp.</li> <li><input type="checkbox"/> <b>[Fast stop] (FSt)</b>: Fast stop.</li> <li><input type="checkbox"/> <b>[DC injection] (dCI)</b>: DC injection stop. This type of stop cannot be used with certain other functions. See table on page 127.</li> </ul>   |                  |                          |

(1) Because, in this case, the fault does not trigger a stop, it is essential to assign a relay or logic output to its indication.

## [1.8 FAULT MANAGEMENT] (FLt-)

| Code  | Name/Description   | Adjustment range | Factory setting      |
|---|--|------------------|----------------------|
| <b>Sdd -</b>  | <b>■ [ENCODER FAULT]</b><br>Can be accessed if the encoder option card has been inserted and the encoder is used for speed feedback (see page 76).   |                  |                      |
| <b>Sdd</b><br>no<br>YES   | <input type="checkbox"/> <b>[Load slip detection]</b><br><br><input type="checkbox"/> <b>[No] (nO)</b> : Fault not monitored. Only the alarm may be assigned to a logic output or a relay.<br><input type="checkbox"/> <b>[Yes] (YES)</b> : Fault monitored.<br>The fault is triggered by comparison with the ramp output and the speed feedback, and is only effective for speeds greater than 10% of the <b>[Rated motor freq.] (FrS)</b> , see page 67.<br>In the event of a fault, the drive will switch to a freewheel stop, and if the brake logic control function has been configured, the brake command will be set to 0.   |                  | <b>[No] (nO)</b>     |
| <b>ECC</b><br>no<br>YES   | <input type="checkbox"/> <b>[Encoder coupling]</b><br><br><input type="checkbox"/> <b>[No] (nO)</b> : Fault not monitored.<br><input type="checkbox"/> <b>[Yes] (YES)</b> : Fault monitored.<br>If the brake logic control function has been configured, the factory setting changes to <b>[Yes] (YES)</b> .<br><b>[Encoder coupling] (ECC) = [Yes] (YES)</b> is only possible if <b>[Load slip detection] (Sdd) = [Yes] (YES)</b> and <b>[Motor control type] (Ctt)</b> page 69 = <b>[FVC] (FUC)</b> and <b>[Brake assignment] (bLC)</b> page 157 is not <b>[No] (nO)</b> .<br>The fault monitored is the break in the mechanical coupling of the encoder.<br>In the event of a fault, the drive will switch to a freewheel stop, and if the brake logic control function has been configured, the brake command will be set to 0.  |                  | <b>[No] (nO)</b>     |
| <b>ECC</b>  | <input type="checkbox"/> <b>[Encoder check time]</b><br><br>Encoder faults filtering time.<br>The parameter can be accessed if <b>[Encoder coupling] (ECC) = [Yes] (YES)</b>   | 2 to 10 s        | 2 s                  |
| <b>tId -</b>  | <b>■ [TORQUE OR I LIM. DETECT]</b>   |                  |                      |
| <b>SSb</b><br>no<br>YES<br>Stt<br><br>LFF<br>rLS<br>rMP<br>FSt<br>dCI | <input type="checkbox"/> <b>[Trq/I limit. stop]</b><br><br>Behavior in the event of switching to torque or current limitation<br><input type="checkbox"/> <b>[Ignore] (nO)</b> : Fault ignored.<br><input type="checkbox"/> <b>[Freewheel] (YES)</b> : Freewheel stop.<br><input type="checkbox"/> <b>[Per STT] (Stt)</b> : Stop according to configuration of <b>[Type of stop] (Stt)</b> page 137, without fault tripping. In this case the fault relay does not open and the drive is ready to restart as soon as the fault disappears, according to the restart conditions of the active command channel (e.g., according to <b>[2/3 wire control] (tCC)</b> and <b>[2 wire type] (tCt)</b> page 86 if control is via the terminals). Configuring an alarm for this fault is recommended (assigned to a logic output, for example) in order to indicate the cause of the stop.<br><input type="checkbox"/> <b>[fallback spd] (LFF)</b> : Change to fallback speed, maintained as long as the fault persists and the run command has not been removed (1).<br><input type="checkbox"/> <b>[Spd maint.] (rLS)</b> : The drive maintains the speed being applied when the fault occurred, as long as the fault is present and the run command has not been removed (1).<br><input type="checkbox"/> <b>[Ramp stop] (rMP)</b> : Stop on ramp.<br><input type="checkbox"/> <b>[Fast stop] (FSt)</b> : Fast stop.<br><input type="checkbox"/> <b>[DC injection] (dCI)</b> : DC injection stop. This type of stop cannot be used with certain other functions. See table on page 127. |                  | <b>[Ignore] (nO)</b> |
| <b>SEd</b><br>( )   | <input type="checkbox"/> <b>[Trq/I limit. time out]</b><br><br>(If fault has been configured)<br>Time delay for taking SSF "Limitation" fault into account   | 0 to 9999 ms     | 1000 ms              |

**( )** Parameter that can be modified during operation or when stopped.

(1) Because, in this case, the fault does not trigger a stop, it is essential to assign a relay or logic output to its indication.

### Use of the "Pulse input" input to measure the speed of rotation of the motor.

This function uses the "Pulse input" input from the VW3A3202 extension card and can, therefore, only be used if this card has been inserted and if the "Pulse input" input is not being used for another function.

#### Example of use

An indexed disk driven by the motor and connected to a proximity sensor can be used to generate a frequency signal that is proportional to the speed of rotation of the motor.

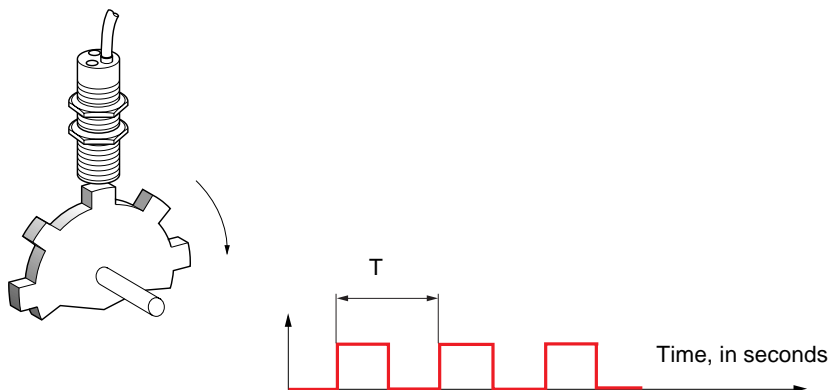

When applied to the "Pulse input" input, this signal supports:

- Measurement and display of the motor speed: signal frequency =  $1/T$ . This frequency is displayed by means of the [Pulse in. work. freq.] (FqS) parameter, page 49 or 51.
- Overspeed detection (if the measured speed exceeds a preset threshold, the drive will trip on a fault).
- Brake failure detection, if brake logic control has been configured: If the speed does not drop sufficiently quickly following a command to engage the brake, the drive will trip on a fault. This function can be used to detect worn brake linings.
- Detection of a speed threshold that can be adjusted using [Pulse warning thd.] (FqL) page 65 and is assignable to a relay or logic output, see page 100.

# [1.8 FAULT MANAGEMENT] (FLt-)

Handling

Elevators

Hoisting

| Code             | Name/Description  | Adjustment range | Factory setting |
|------------------|---|------------------|-----------------|
| <b>F9F-</b>      | <b>[FREQUENCY METER]</b><br>Can be accessed if a VW3A3202 option card has been inserted   |                  |                 |
| F9F<br>n0<br>YES | <input type="checkbox"/> <b>[Frequency meter]</b><br>Activation of the speed measurement function.<br><input type="checkbox"/> <b>[No] (nO)</b> : Function inactive, In this case, none of the function parameters can be accessed.<br><input type="checkbox"/> <b>[Yes] (YES)</b> : Function active, assignment only possible if no other functions have been assigned to the "Pulse input" input.   |                  | [No] (nO)       |
| F9C              | <input type="checkbox"/> <b>[Pulse scal. divisor]</b><br><ul style="list-style-type: none"> <li>Scaling factor for the "Pulse input" input (divisor). The frequency measured is displayed by means of the [Pulse in. work. freq.] (FqS) parameter, page 49 or 51.</li> </ul>  | 1.0 to 100.0     | 1.0             |
| F9A<br>n0<br>-   | <input type="checkbox"/> <b>[Overspd. pulse thd.]</b><br>Activation and adjustment of overspeed monitoring: [Overspeed] (SOF) fault.<br><input type="checkbox"/> <b>[No] (nO)</b> : No overspeed monitoring.<br><input type="checkbox"/> <b>1 Hz to 30.00 Hz</b> : Adjustment of the frequency tripping threshold on the "Pulse input" input divided by [Pulse scal. divisor] (FqC).  |                  | [No] (nO)       |
| t d S            | <input type="checkbox"/> <b>[Pulse overspd delay]</b><br>Time delay for taking overspeed fault into account   | 0.0 s to 10.0 s  | 0.0 s           |
| F d t<br>n0<br>- | <input type="checkbox"/> <b>[Level fr. pulse ctrl]</b><br>Activation and adjustment of monitoring for the input Pulse input (speed feedback): [Speed fdbck loss] (SPF) fault.<br><input type="checkbox"/> <b>[No] (nO)</b> : No monitoring of speed feedback.<br><input type="checkbox"/> <b>0.1 Hz to 500.0 Hz</b> : Adjustment of the motor frequency threshold for tripping a speed feedback fault (difference between the estimated frequency and the measured speed).                              |                  | [No] (nO)       |
| F9t<br>n0<br>-   | <input type="checkbox"/> <b>[Pulse thd. wo Run]</b><br>Activation and adjustment of brake failure monitoring: [Brake feedback] (brF). If brake logic control [Brake assignment] (bLC) page 157 is not configured, this parameter is forced to [No] (nO).<br><input type="checkbox"/> <b>[No] (nO)</b> : No brake monitoring.<br><input type="checkbox"/> <b>1 Hz to 1000 Hz</b> : Adjustment of the motor frequency threshold for tripping a brake failure fault (detection of speeds other than zero). |                  | [No] (nO)       |
| t 9 b            | <input type="checkbox"/> <b>[Pulse thd. wo Run]</b><br>Time delay for taking brake failure fault into account.  | 0.0 s to 10.0 s  | 0.0 s           |

## [1.8 FAULT MANAGEMENT] (FLt-)

---

### Load variation detection

This detection is only possible with the "high-speed hoisting" function. It can be used to detect if an obstacle has been reached, triggering a sudden (upward) increase or (downward) decrease in the load.

Load variation detection triggers a [\[Dynamic load fault\] fault \(dLF\)](#). The [\[Dyn. load Mgt.\] \(dLb\)](#) parameter can be used to configure the response of the drive in the event of this fault.

Load variation detection can also be assigned to a relay or a logic output.

There are two possible detection modes, depending on the configuration of high-speed hoisting:

#### "Speed reference" mode

[\[High speed hoisting\] \(HSO\)](#) page [168](#) = [\[Speed ref\] \(SSO\)](#).

Torque variation detection.

During high-speed operation, the load is compared to that measured during the speed step. The permissible load variation and its duration can be configured. If exceeded, the drive switches to fault mode.

#### "Current limitation" mode

[\[High speed hoisting\] \(HSO\)](#) page [168](#) = [\[Current Limit\] \(CSO\)](#).

On ascend, during high-speed operation, an increase in load will result in a drop in speed. Even if high-speed operation has been activated, if the motor frequency drops below the [\[Limit Frequency\] \(SCL\)](#) threshold page [168](#) the drive will switch to fault mode.

On descend, operation takes the form of "speed reference" mode.



# [1.8 FAULT MANAGEMENT] (FLt-)

Hoisting

| Code        | Name/Description  | Adjustment range | Factory setting                   |
|-------------|---|------------------|-----------------------------------|
| <b>dLd-</b> | <b>■ [DYNAMIC LOAD DETECT.]</b><br>Load variation detection. This can be accessed if <a href="#">[High speed hoisting] (HSO)</a> page <a href="#">168</a> is not <a href="#">[No] (nO)</a> .  |                  |                                   |
| <b>ELd</b>  | <input type="checkbox"/> <b>[Dynamic load time]</b><br>Activation of load variation detection and adjustment of time delay for taking load variation fault <a href="#">[Dynamic load fault] (dLF)</a> into account.   |                  | <a href="#">[No] (nO)</a>         |
| <b>nO</b>   | <input type="checkbox"/> <a href="#">[No] (nO)</a> : No load variation detection.<br><input type="checkbox"/> <a href="#">0.00 s to 10.00 s</a> : Adjustment of the time delay for taking fault into account.   |                  |                                   |
| <b>dLd</b>  | <input type="checkbox"/> <b>[Dynamic load time]</b><br>Adjustment of the trip threshold for load variation detection, as a % of rated motor torque.   | 1 to 100 %       | 100 %                             |
| <b>dLb</b>  | <input type="checkbox"/> <b>[Dyn. load Mgt.]</b><br>Behavior of the drive in the event of a load variation fault.   |                  | <a href="#">[Freewheel] (YES)</a> |
| <b>nO</b>   | <input type="checkbox"/> <a href="#">[Ignore] (nO)</a> : Fault ignored.   |                  |                                   |
| <b>YES</b>  | <input type="checkbox"/> <a href="#">[Freewheel] (YES)</a> : Freewheel stop.  |                  |                                   |
| <b>Stt</b>  | <input type="checkbox"/> <a href="#">[Per STT] (Stt)</a> : Stop according to configuration of <a href="#">[Type of stop] (Stt)</a> page <a href="#">137</a> , without tripping fault. In this case the fault relay does not open and the drive is ready to restart as soon as the fault disappears, according to the restart conditions of the active command channel, (e.g. according to <a href="#">[2/3 wire control] (tCC)</a> and <a href="#">[2 wire type] (tCt)</a> page <a href="#">86</a> if control is via the terminals). Configuring an alarm for this fault is recommended (assigned to a logic output, for example) in order to indicate the cause of the stop. |                  |                                   |
| <b>LFF</b>  | <input type="checkbox"/> <a href="#">[Fallback spd.] (LFF)</a> : Change to fallback speed, maintained as long as the fault persists and the run command has not been removed (1).   |                  |                                   |
| <b>rLS</b>  | <input type="checkbox"/> <a href="#">[Spd maint.] (rLS)</a> : The drive maintains the speed at the time the fault occurred, as long as the fault persists and the run command has not been removed (1).   |                  |                                   |
| <b>rMP</b>  | <input type="checkbox"/> <a href="#">[Ramp stop] (rMP)</a> : Stop on ramp.  |                  |                                   |
| <b>FSt</b>  | <input type="checkbox"/> <a href="#">[Fast stop] (FSt)</a> : Fast stop.   |                  |                                   |

(1) Because, in this case, the fault does not trigger a stop, it is essential to assign a relay or logic output to its indication.

## [1.8 FAULT MANAGEMENT] (FLt-)

| Code  | Name/Description   | Adjustment range                         | Factory setting          |
|---|--|--|--------------------------|
| <b>brP-</b>   | <b>■ [DB RES. PROTECTION]</b>  |  |                          |
| <b>brO</b><br><b>nO</b><br><b>YES</b><br><b>FLt</b>   | <input type="checkbox"/> <b>[DB res. protection]</b><br><br><input type="checkbox"/> <b>[No] (nO)</b> : No braking resistor protection (thereby preventing access to the other function parameters).<br><input type="checkbox"/> <b>[Alarm] (YES)</b> : Alarm. The alarm may be assigned to a logic output or a relay (see page 100)<br><input type="checkbox"/> <b>[Fault] (FLt)</b> : Switch to fault (bOF) with locking of drive (freewheel stop).<br><br> <b>Note:</b> The thermal state of the resistor can be displayed on the graphic display terminal. It is calculated for as long as the drive control remains connected to the power supply. |  | <b>[No] (nO)</b>         |
| <b>brP</b><br> | <input type="checkbox"/> <b>[DB Resistor Power]</b><br><br>This parameter can be accessed if <b>[DB res. protection] (brO)</b> is not <b>[No] (nO)</b> .<br>Rated power of the resistor used.  | 0.1 kW (0.13 HP) to<br>1000 kW (1333 HP) | 0.1 kW (0.13 HP)         |
| <b>brU</b><br> | <input type="checkbox"/> <b>[DB Resistor value]</b><br><br>This parameter can be accessed if <b>[DB res. protection] (brO)</b> is not <b>[No] (nO)</b> .<br>Rated value of the braking resistor in ohms.   | 0.1 to 200 ohms                          | 0.1 ohms                 |
| <b>bUF-</b>   | <b>■ [BU PROTECTION]</b><br>This can be accessed from 55 kW (75 HP) upwards for the ATV71●●●M3X and from 90 kW (120 HP) upwards for the ATV71●●●N4.  |  |                          |
| <b>bUb</b><br><b>nO</b><br><b>YES</b>   | <input type="checkbox"/> <b>[Brake res. fault Mgt]</b><br><br>Management of short-circuit <b>[DB unit sh. circuit] (bUF)</b> and overheating <b>[Internal- th. sensor] (InFb) faults</b> in the braking unit.<br><input type="checkbox"/> <b>[Ignore] (nO)</b> : Fault ignored. <b>Configuration to be used if there is no resistor or braking unit connected to the drive.</b><br><input type="checkbox"/> <b>[Freewheel] (YES)</b> : freewheel stop.   |  | <b>[Freewheel] (YES)</b> |
| <b>tnF-</b>   | <b>■ [AUTO TUNING FAULT]</b>   |  |                          |
| <b>tnL</b><br><b>nO</b><br><b>YES</b>   | <input type="checkbox"/> <b>[Autotune fault mgt]</b><br><br><input type="checkbox"/> <b>[Ignore] (nO)</b> : Fault ignored.<br><input type="checkbox"/> <b>[Freewheel] (YES)</b> : Freewheel stop.  |  | <b>[Freewheel] (YES)</b> |

 Parameter that can be modified during operation or when stopped.

## [1.8 FAULT MANAGEMENT] (FLt-)

### Card pairing

Function can only be accessed in **[Expert]** mode.

This function is used to detect whenever a card has been replaced or the software has been modified in any way.

When a pairing password is entered, the parameters of the cards currently inserted are stored. On every subsequent power-up these parameters are verified and, in the event of a discrepancy, the drive locks in HCF fault mode. Before the drive can be restarted you must revert to the original situation or re-enter the pairing password.

The following parameters are verified:

- The type of card for: all cards.
- The software version for: the two control cards, the VW3A3202 extension card, the Controller Inside card and the communication cards.
- The serial number for: the two control cards.

| Code         | Name/Description  | Adjustment range | Factory setting    |
|--------------|---|------------------|--------------------|
| <b>PP I-</b> | <b>■ [CARDS PAIRING]</b>  |                  |                    |
| <b>PP I</b>  | <input type="checkbox"/> <b>[Pairing password]</b><br><br>The <b>[OFF] (OFF)</b> value signifies that the card pairing function is inactive.<br>The <b>[ON] (On)</b> value signifies that card pairing is active and that an access code must be entered in order to start the drive in the event of a card pairing fault.<br>As soon as the code has been entered the drive is unlocked and the code changes to <b>[ON] (On)</b> .<br>- The PPI code is an unlock code known only to Schneider Electric Product Support. | OFF to 9999      | <b>[OFF] (OFF)</b> |



## [1.8 FAULT MANAGEMENT] (FLt-)

| Code               | Name/Description   | Adjustment range                         | Factory setting |
|--------------------|--|--|-----------------|
| <b>LFF -</b>       | <b>■ [FALLBACK SPEED]</b>  |  |                 |
| <b>LFF</b>         | <input type="checkbox"/> [Fallback speed]<br>Selection of the fallback speed   | 0 to 1600 Hz                             | 0 Hz            |
| <b>FSE -</b>       | <b>■ [RAMP DIVIDER]</b>  |  |                 |
| <b>dCF</b><br>( )  | <input type="checkbox"/> [Ramp divider] (1)<br>The ramp that is enabled (dEC or dE2) is then divided by this coefficient when stop requests are sent. Value 0 corresponds to a minimum ramp time.  | 0 to 10                                  | 4               |
| <b>dCI -</b>       | <b>■ [DC INJECTION]</b>  |  |                 |
| <b>IdC</b><br>( )  | <input type="checkbox"/> [DC inject. level 1] (1) (3)<br>Level of DC injection braking current activated via logic input or selected as stop mode.<br><br><b>CAUTION</b><br>Check that the motor will withstand this current without overheating.<br><b>Failure to follow this instruction can result in equipment damage.</b>   | 0.1 to 1.41 In (2)                       | 0.64 In (2)     |
| <b>tdI</b><br>( )  | <input type="checkbox"/> [DC injection time 1] (1) (3)<br>Maximum current injection time [DC inject. level 1] (IdC). After this time the injection current becomes [DC inject. level 2] (IdC2).  | 0.1 to 30 s                              | 0.5 s           |
| <b>IdC2</b><br>( ) | <input type="checkbox"/> [DC inject. level 2] (1) (3)<br>Injection current activated by logic input or selected as stop mode, once period of time [DC injection time 1] (tdI) has elapsed.<br><br><b>CAUTION</b><br>Check that the motor will withstand this current without overheating.<br><b>Failure to follow this instruction can result in equipment damage.</b> | 0.1 In (2) to [DC inject. level 1] (IdC) | 0.5 In (2)      |
| <b>tdC</b><br>( )  | <input type="checkbox"/> [DC injection time 2] (1) (3)<br>Maximum injection time [DC inject. level 2] (IdC2) for injection, selected as stop mode only. (Can be accessed if [Type of stop] (Stt) = [DC injection] (dCI)).  | 0.1 to 30 s                              | 0.5 s           |

(1) The parameter can also be accessed in the [1.3 SETTINGS] (SEt-) and [1.7 APPLICATION FUNCT.] (FUn-) menus.

(2) In corresponds to the rated drive current indicated in the Installation Manual and on the drive nameplate.

(3) Warning: These settings are independent of the [AUTO DC INJECTION] (AdC-) function.

( ) Parameter that can be modified during operation or when stopped.

# [1.9 COMMUNICATION] (COM-)

With graphic display terminal:

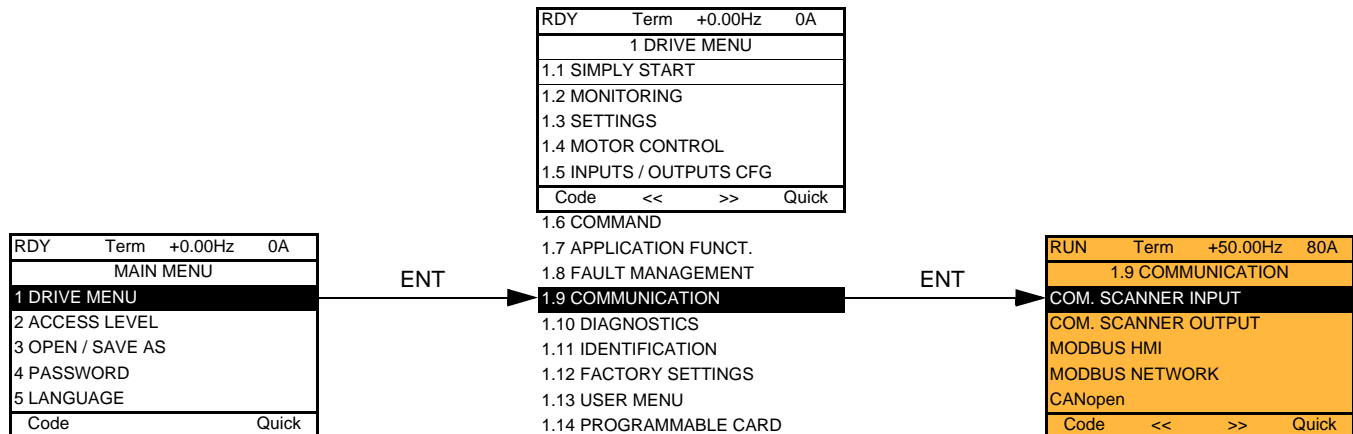

With integrated display terminal:

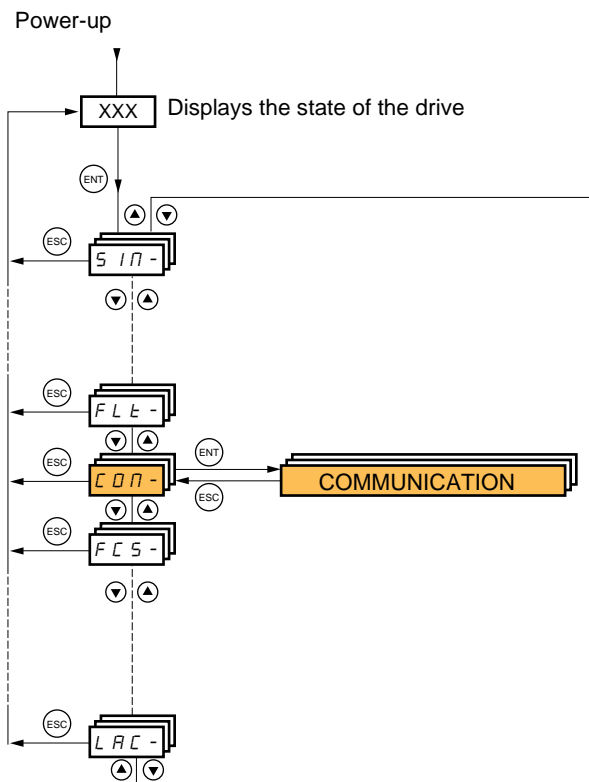

## [1.9 COMMUNICATION] (COM-)

| Code   | Name/Description   | Adjustment range | Factory setting |
|--|--|------------------|-----------------|
| <b>■ [COM. SCANNER INPUT]</b><br>Only accessible via graphic display terminal  |  |                  |                 |
| nPA1   | <input type="checkbox"/> <b>[Scan. IN1 address]</b><br>Address of the 1 <sup>st</sup> input word.  |                  | 3201            |
| nPA2   | <input type="checkbox"/> <b>[Scan. IN2 address]</b><br>Address of the 2 <sup>nd</sup> input word.  |                  | 8604            |
| nPA3   | <input type="checkbox"/> <b>[Scan. IN3 address]</b><br>Address of the 3 <sup>rd</sup> input word.  |                  | 0               |
| nPA4   | <input type="checkbox"/> <b>[Scan. IN4 address]</b><br>Address of the 4 <sup>th</sup> input word.  |                  | 0               |
| nPA5   | <input type="checkbox"/> <b>[Scan. IN5 address]</b><br>Address of the 5 <sup>th</sup> input word.  |                  | 0               |
| nPA6   | <input type="checkbox"/> <b>[Scan. IN6 address]</b><br>Address of the 6 <sup>th</sup> input word.  |                  | 0               |
| nPA7   | <input type="checkbox"/> <b>[Scan. IN7 address]</b><br>Address of the 7 <sup>th</sup> input word.  |                  | 0               |
| nPA8   | <input type="checkbox"/> <b>[Scan. IN8 address]</b><br>Address of the 8 <sup>th</sup> input word.  |                  | 0               |
| <b>■ [COM. SCANNER OUTPUT]</b><br>Only accessible via graphic display terminal |  |                  |                 |
| nCA1   | <input type="checkbox"/> <b>[Scan.Out1 address]</b><br>Address of the 1 <sup>st</sup> output word. |                  | 8501            |
| nCA2   | <input type="checkbox"/> <b>[Scan.Out2 address]</b><br>Address of the 2 <sup>nd</sup> output word. |                  | 8602            |
| nCA3   | <input type="checkbox"/> <b>[Scan.Out3 address]</b><br>Address of the 3 <sup>rd</sup> output word. |                  | 0               |
| nCA4   | <input type="checkbox"/> <b>[Scan.Out4 address]</b><br>Address of the 4 <sup>th</sup> output word. |                  | 0               |
| nCA5   | <input type="checkbox"/> <b>[Scan.Out5 address]</b><br>Address of the 5 <sup>th</sup> output word. |                  | 0               |
| nCA6   | <input type="checkbox"/> <b>[Scan.Out6 address]</b><br>Address of the 6 <sup>th</sup> output word. |                  | 0               |
| nCA7   | <input type="checkbox"/> <b>[Scan.Out7 address]</b><br>Address of the 7 <sup>th</sup> output word. |                  | 0               |
| nCA8   | <input type="checkbox"/> <b>[Scan.Out8 address]</b><br>Address of the 8 <sup>th</sup> output word. |                  | 0               |

## [1.9 COMMUNICATION] (COM-)

| Code        | Name/Description  | Adjustment range | Factory setting |
|-------------|---|------------------|-----------------|
| <b>nd2-</b> | <b>■ [MODBUS HMI]</b><br>Communication with the graphic display terminal  |                  |                 |
| <b>tbr2</b> | <input type="checkbox"/> <b>[HMI baud rate]</b><br>9.6 or 19.2 kbps via the integrated display terminal.<br>9600 or 19200 bauds via the graphic display terminal.<br>The graphic display terminal only operates if [HMI baud rate] (tbr2) = 19200 bauds (19.2 kbps).<br>In order for any change in the assignment of [HMI baud rate] (tbr2) to be taken into account you must:<br>- Provide confirmation in a confirmation window if using the graphic display terminal<br>- Press the ENT key for 2 s if using the integrated display terminal |                  | 19.2 kbps       |
| <b>tFO2</b> | <input type="checkbox"/> <b>[HMI format]</b><br>Read-only parameter, cannot be modified.  |                  | 8E1             |
| <b>nd1-</b> | <b>■ [MODBUS NETWORK]</b>   |                  |                 |
| <b>add</b>  | <input type="checkbox"/> <b>[Modbus Address]</b><br>OFF to 247  |                  | OFF             |
| <b>ANDR</b> | <input type="checkbox"/> <b>[Modbus add Prg C.]</b><br>Modbus address of the Controller Inside card<br>OFF at 247<br>The parameter can be accessed if the Controller Inside card has been inserted and depending on its configuration (please consult the specific documentation).  |                  | OFF             |
| <b>ANDC</b> | <input type="checkbox"/> <b>[Modbus add Com.C.]</b><br>Modbus address of the communication card<br>OFF to 247<br>The parameter can be accessed if a communication card has been inserted and depending on its configuration (please consult the specific documentation).  |                  | OFF             |
| <b>tbr</b>  | <input type="checkbox"/> <b>[Modbus baud rate]</b><br>4.8 - 9.6 - 19.2 - 38.4 kbps on the integrated display terminal.<br>4800, 9600, 19200 or 38400 bauds on the graphic display terminal.   |                  | 19.2 kbps       |
| <b>tFO</b>  | <input type="checkbox"/> <b>[Modbus format]</b><br>801 - 8E1 - 8n1, 8n2   |                  | 8E1             |
| <b>tEO</b>  | <input type="checkbox"/> <b>[Modbus time out]</b><br>0.1 to 30 s  |                  | 10.0 s          |
| <b>cn0-</b> | <b>■ [CANopen]</b>  |                  |                 |
| <b>adCO</b> | <input type="checkbox"/> <b>[CANopen address]</b><br>OFF to 127   |                  | OFF             |
| <b>bdCO</b> | <input type="checkbox"/> <b>[CANopen bit rate]</b><br>50 - 125 - 250 - 500 kbps - 1 Mbps  |                  | 125 kbps        |
| <b>erCO</b> | <input type="checkbox"/> <b>[Error code]</b><br>Read-only parameter, cannot be modified.  |                  |                 |

## [1.9 COMMUNICATION] (COM-)

| Code   | Name/Description   | Adjustment range | Factory setting |
|--|--|------------------|-----------------|
| -  | <p><b>■ [COMMUNICATION CARD]</b></p> <p>See the specific documentation for the card used.</p>  |                  |                 |
| LCF-   | <p><b>■ [FORCED LOCAL]</b></p>   |                  |                 |
| <p>FLO</p> <p>n0</p> <p>L11</p> <p>-</p> <p>L114</p>   | <p><input type="checkbox"/> <b>[Forced local assign.]</b></p> <p><input type="checkbox"/> <b>[No] (n0)</b>: Function inactive</p> <p><input type="checkbox"/> <b>[LI1] (LI1) to [LI6] (LI6)</b></p> <p><input type="checkbox"/> <b>[LI7] (LI7) to [LI10] (LI10)</b>: If VW3A3201 logic I/O card has been inserted</p> <p><input type="checkbox"/> <b>[LI11] (LI11) to [LI14] (LI14)</b>: If VW3A3202 extended I/O card has been inserted</p> <p>Forced local mode is active when the input is at state 1.<br/> <b>[Forced local assign.] (FLO)</b> is forced to <b>[No] (n0)</b> if <b>[Profile] (CHCF)</b> page 122 = <b>[I/O profile] (IO)</b>.</p>  |                  | [No] (n0)       |
| <p>FLOC</p> <p>n0</p> <p>A11</p> <p>A12</p> <p>A13</p> <p>A14</p> <p>LCC</p> <p>PI</p> <p>PG</p> | <p><input type="checkbox"/> <b>[Forced local Ref.]</b></p> <p><input type="checkbox"/> <b>[No] (n0)</b>: Not assigned (control via the terminals with zero reference).</p> <p><input type="checkbox"/> <b>[AI1] (AI1)</b>: Analog input</p> <p><input type="checkbox"/> <b>[AI2] (AI2)</b>: Analog input</p> <p><input type="checkbox"/> <b>[AI3] (AI3)</b>: Analog input, if VW3A3202 extension card has been inserted</p> <p><input type="checkbox"/> <b>[AI4] (AI4)</b>: Analog input, if VW3A3202 extension card has been inserted</p> <p><input type="checkbox"/> <b>[HMI] (LCC)</b>: Assignment of the reference and command to the graphic display terminal.<br/> Reference: <b>[HMI Frequency ref.] (LFr)</b>, page 49, command: RUN/STOP/FWD/REV buttons.</p> <p><input type="checkbox"/> <b>[RP] (PI)</b>: Frequency input, if VW3A3202 extension card has been inserted</p> <p><input type="checkbox"/> <b>[Encoder] (PG)</b>: Encoder input, if encoder card has been inserted</p> <p>If the reference is assigned to an analog input, <b>[RP] (PI)</b> or <b>[Encoder] (PG)</b> the command is automatically assigned to the terminals as well (logic inputs)</p> |                  | [No] (n0)       |
| FLOt   | <p><input type="checkbox"/> <b>[Time-out forc. local]</b></p> <p>0.1 to 30 s</p> <p>The parameter can be accessed if <b>[Forced local assign.] (FLO)</b> is not <b>[No] (n0)</b>.</p> <p>Time delay before communication monitoring is resumed on leaving forced local mode.</p>   |                  | 10.0 s          |

# [1.10 DIAGNOSTICS]

This menu can only be accessed with the graphic display terminal.

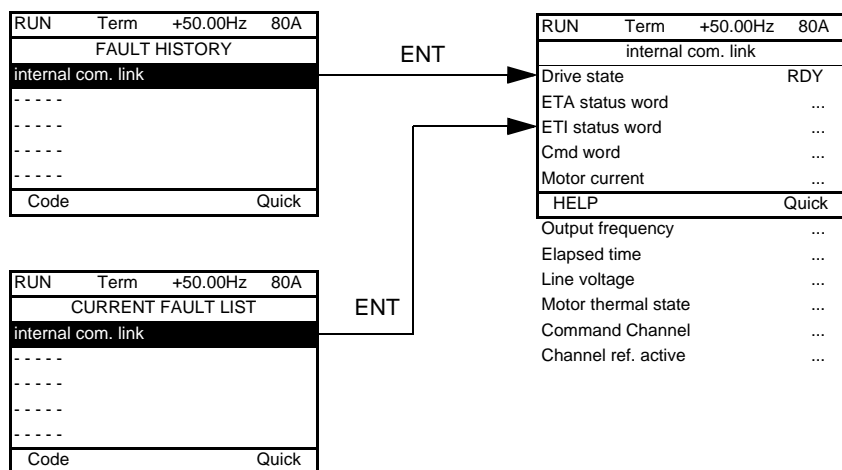
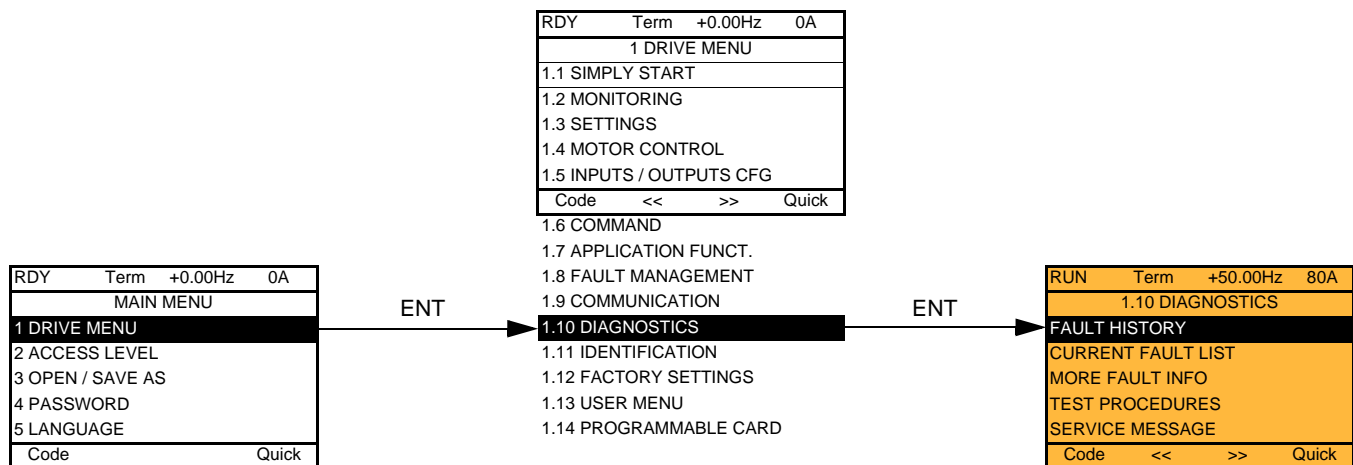

This screen indicates the state of the drive at the moment the selected fault occurred.

|                       |       |
|-----------------------|-------|
| RUN Term +50.00Hz 80A |       |
| MORE FAULT INFO       |       |
| Network fault         | 0     |
| Application fault     | 0     |
| Internal link fault 1 | 0     |
| Internal link fault 2 | 0     |
| Code                  | Quick |

This screen indicates the number of communication faults, for example, with the option cards.  
Number: from 0 to 65535

# [1.10 DIAGNOSTICS]

[THYRISTORS TEST] is only accessible for ATV71●●●M3 ≥ 18.5 kW (25 HP) and ATV71●●●N4 □ 18.5 kW (25 HP) drives.

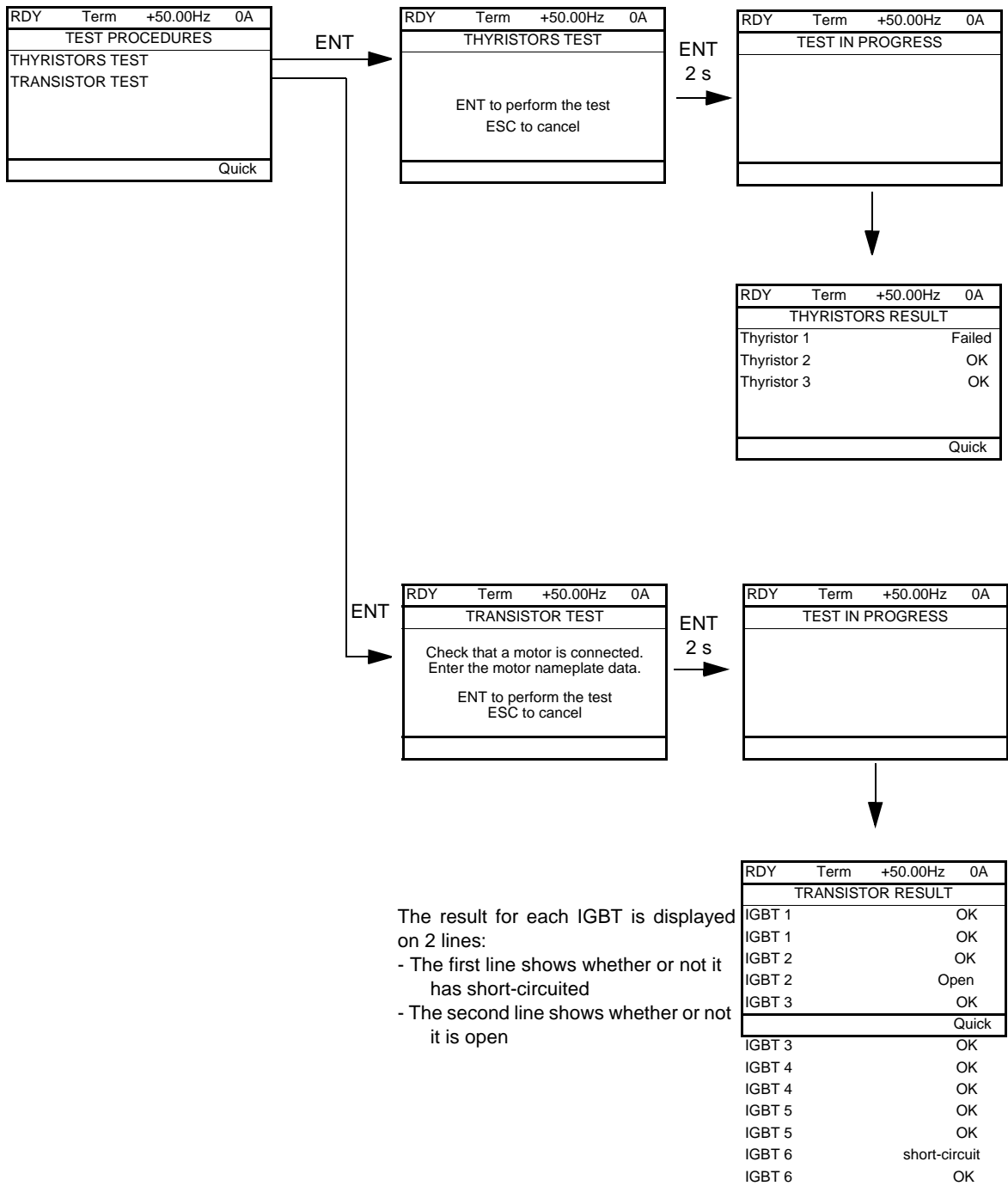

The result for each IGBT is displayed on 2 lines:

- The first line shows whether or not it has short-circuited
- The second line shows whether or not it is open

**Note:** To start the tests, press and hold down (2 s) the ENT key.

## [1.11 IDENTIFICATION]

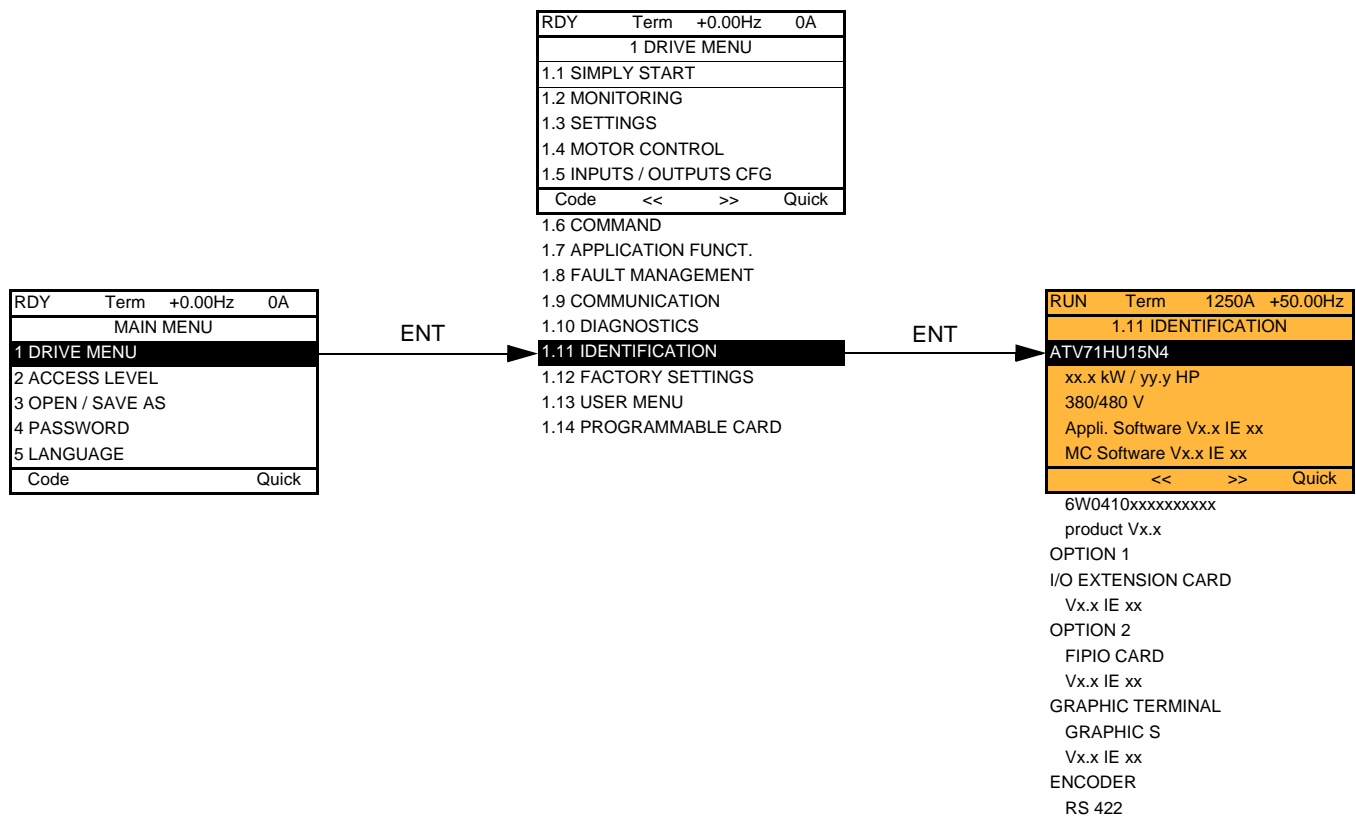

The [1.11 IDENTIFICATION] menu can only be accessed on the graphic display terminal.

This is a read-only menu that cannot be configured. It enables the following information to be displayed:

- Drive reference, power rating and voltage
- Drive software version
- Drive serial number
- Type of options present, with their software version



## [1.12 FACTORY SETTINGS] (FCS-)

With graphic display terminal:

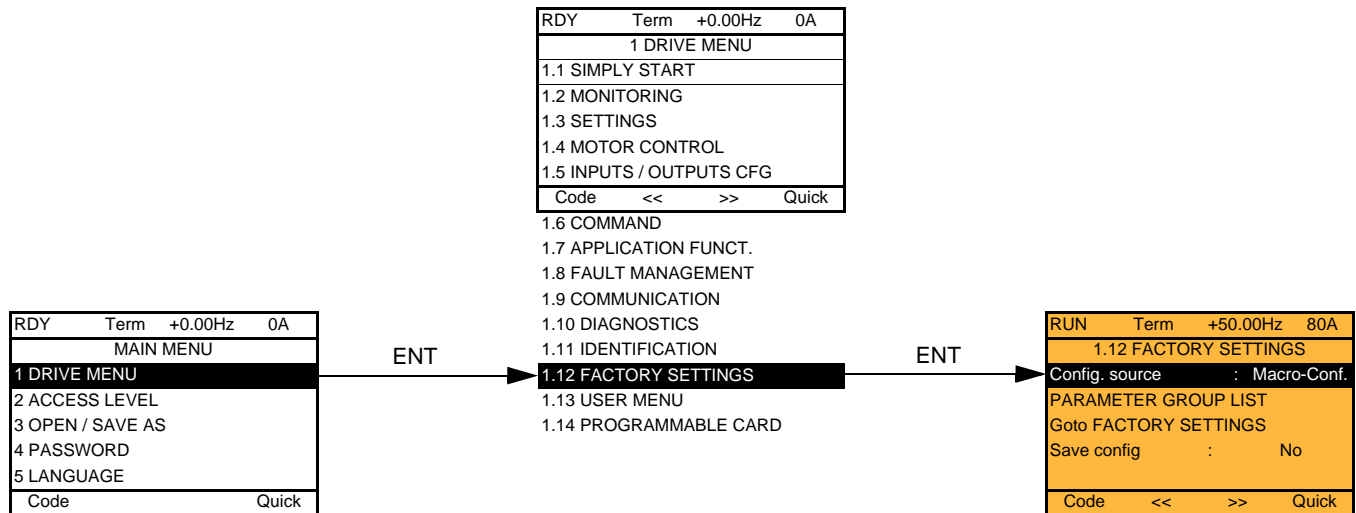

With integrated display terminal:

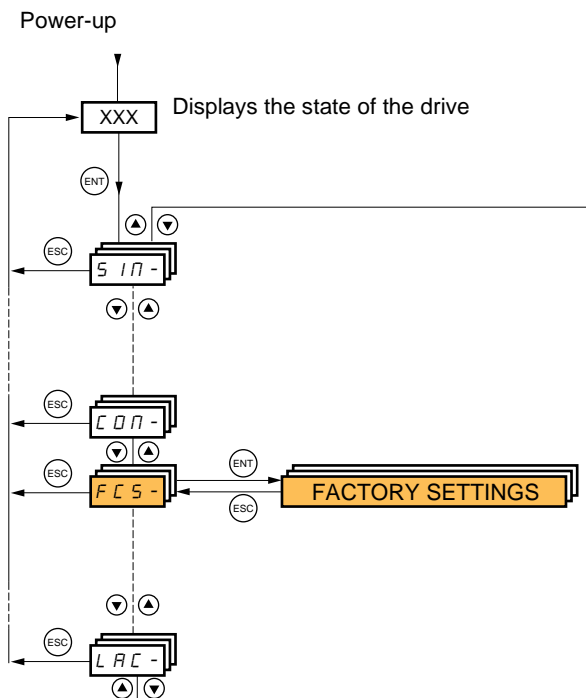

The [1.12 FACTORY SETTINGS] (FCS-) menu is used to:

- Replace the current configuration with the factory configuration or a previously saved configuration. All or part of the current configuration can be replaced: select a group of parameters in order to select the menus you wish to load with the selected source configuration.
- Save the current configuration to a file.

# [1.12 FACTORY SETTINGS] (FCS-)

|                       |      |             |          |
|-----------------------|------|-------------|----------|
| RUN                   | Term | 1250A       | +50.00Hz |
| 1.12 FACTORY SETTINGS |      |             |          |
| Config. source        | :    | Macro-Conf. |          |
| PARAMETER GROUP LIST  |      |             |          |
| Goto FACTORY SETTINGS |      |             |          |
| Save config           | :    | No          |          |
| Code                  | <<   | >>          | Quick    |

ENT

|                |      |                                     |          |
|----------------|------|-------------------------------------|----------|
| RUN            | Term | 1250A                               | +50.00Hz |
| Config. Source |      |                                     |          |
| Macro-Conf     |      | <input checked="" type="checkbox"/> |          |
| Config 1       |      | <input type="checkbox"/>            |          |
| Config 2       |      | <input type="checkbox"/>            |          |
| Quick          |      |                                     |          |

Selection of source configuration

ENT

|                      |      |                                     |          |
|----------------------|------|-------------------------------------|----------|
| RUN                  | Term | 1250A                               | +50.00Hz |
| PARAMETER GROUP LIST |      |                                     |          |
| All                  |      | <input checked="" type="checkbox"/> |          |
| Drive menu           |      | <input type="checkbox"/>            |          |
| Settings             |      | <input type="checkbox"/>            |          |
| Motor param          |      | <input type="checkbox"/>            |          |
| Comm. menu           |      | <input type="checkbox"/>            |          |
| Code                 |      |                                     | Quick    |

Selection of the menus to be replaced

**Note:** In factory configuration and after a return to "factory settings", [PARAMETER GROUP LIST] will be empty.

ENT

|  |      |       |          |
|--|------|-------|----------|
| RUN                                      | Term | 1250A | +50.00Hz |
| Goto FACTORY SETTINGS                    |      |       |          |
| PLEASE CHECK THAT THE DRIVE WIRING IS OK |      |       |          |
| ESC=abort      ENT=validate              |      |       |          |

Command to return to "factory settings"

ENT

|                                     |      |       |          |
|-------------------------------------|------|-------|----------|
| RUN                                 | Term | 1250A | +50.00Hz |
| Goto FACTORY SETTINGS               |      |       |          |
| First select the parameter group(s) |      |       |          |
| Press ENT or ESC to continue        |      |       |          |

This window appears if no group of parameters is selected.

|             |      |                          |          |
|-------------|------|--------------------------|----------|
| RUN         | Term | 1250A                    | +50.00Hz |
| Save config |      |                          |          |
| No          |      | <input type="checkbox"/> |          |
| Config 0    |      | <input type="checkbox"/> |          |
| Config 1    |      | <input type="checkbox"/> |          |
| Config 2    |      | <input type="checkbox"/> |          |
| Quick       |      |                          |          |

## [1.12 FACTORY SETTINGS] (FCS-)

| Code  | Name/Description  |
|---|---|
| <b>FCS1</b><br><br>In1<br>CFG1<br>CFG2  | <input type="checkbox"/> <b>[Config. Source]</b><br><br>Choice of source configuration.<br><input type="checkbox"/> <b>[Macro-Conf] (In1)</b> Factory configuration, return to selected macro configuration.<br><input type="checkbox"/> <b>[Config 1] (CFG1)</b><br><input type="checkbox"/> <b>[Config 2] (CFG2)</b><br>If the configuration switching function is configured, it will not be possible to access <b>[Config 1] (CFG1)</b> and <b>[Config 2] (CFG2)</b> .  |
| <b>FrY-</b><br><br>ALL<br>drM<br><br>SEt<br><br>MOt<br><br>COM<br><br>PLC<br>MOn<br>dIS | <input type="checkbox"/> <b>[PARAMETER GROUP LIST]</b><br><br>Selection of menus to be loaded<br><input type="checkbox"/> <b>[All] (ALL)</b> : All parameters.<br><input type="checkbox"/> <b>[Drive menu] (drM)</b> : The [1 DRIVE MENU] menu without [1.9 COMMUNICATION] and [1.14 PROGRAMMABLE CARD]. In the [7 DISPLAY CONFIG.] menu, <b>[Return std name]</b> page 255 returns to <b>[No]</b> .<br><input type="checkbox"/> <b>[Settings] (SEt)</b> : The [1.3 SETTINGS] menu without the <b>[IR compensation] (UFR)</b> , <b>[Slip compensation] (SLP)</b> and <b>[Mot. therm. current] (ItH)</b> parameters<br><input type="checkbox"/> <b>[Motor param] (MOt)</b> : motor parameters, see list below.<br>The following selections can only be accessed if <b>[Config. Source] (FCS1) = [Macro-Conf.] (In1)</b> :<br><input type="checkbox"/> <b>[Comm. menu] (COM)</b> : The [1.9 COMMUNICATION] menu without either <b>[Scan. In1 address] (nMA1)</b> to <b>[Scan. In8 address] (nMA8)</b> or <b>[Scan.Out1 address] (nCA1)</b> to <b>[Scan.Out8 address] (nCA8)</b> .<br><input type="checkbox"/> <b>[Prog. card menu] (PLC)</b> : the [1.14 PROGRAMMABLE CARD] menu.<br><input type="checkbox"/> <b>[Monitor config.] (MOn)</b> : the [6 MONITORING CONFIG.] menu.<br><input type="checkbox"/> <b>[Display config.] (dIS)</b> : the [7 DISPLAY CONFIG.] menu.<br>See the multiple selection procedure on page 28 for the integrated display terminal and page 19 for the graphic display terminal.<br> <b>Note:</b> In factory configuration and after a return to "factory settings", <b>[PARAMETER GROUP LIST]</b> will be empty. |
| <b>GFS</b><br><br>nO<br>YES   | <input type="checkbox"/> <b>[Goto FACTORY SETTINGS]</b><br><br>It is only possible to revert to the factory settings if at least one group of parameters has previously been selected.<br>With the integrated display terminal:<br>- No<br>- Yes: The parameter changes back to nO automatically as soon as the operation is complete.<br>With the graphic display terminal: see previous page  |
| <b>SCS1</b><br><br>nO<br>Str0<br>Str1<br>Str2   | <input type="checkbox"/> <b>[Save config]</b><br><br><input type="checkbox"/> <b>[No] (nO)</b> :<br><input type="checkbox"/> <b>[Config 0] (Str0)</b> : Press and hold down the "ENT" key for 2 s.<br><input type="checkbox"/> <b>[Config 1] (Str0)</b> : Press and hold down the "ENT" key for 2 s.<br><input type="checkbox"/> <b>[Config 2] (Str0)</b> : Press and hold down the "ENT" key for 2 s.<br>The active configuration to be saved does not appear for selection. For example, if it is <b>[Config 0] (Str0)</b> , only <b>[Config 1] (Str1)</b> and <b>[Config 2] (Str2)</b> appear. The parameter changes back to <b>[No] (nO)</b> as soon as the operation is complete.  |

### List of motor parameters

#### [1.4 MOTOR CONTROL] (drC-) menu:

**[Rated motor power] (nPr)** - **[Rated motor volt.] (UnS)** - **[Rated mot current] (nCr)** - **[Rated motor freq.] (FrS)** - **[Rated motor speed] (nSP)** - **[Auto tuning] (tUn)** - **[Auto tuning status] (tUS)** - **[U0] (U0)** to **[U5] (U5)** - **[F1] (F1)** to **[F5] (F5)** - **[V. constant power] (UCP)** - **[Freq. Const Power] (FCP)** - **[Nominal I sync] (nCrS)** - **[Nom motor spd sync] (nSPS)** - **[Pole pairs.] (PPnS)** - **[Syn. EMF constant] (PHS)** - **[Autotune L d-axis] (LdS)** - **[Autotune L q-axis] (LqS)** - **[Cust. stator R syn] (rSAS)** - **[IR compensation] (UFR)** - **[Slip compensation] (SLP)** - motor parameters that can be accessed in **[Expert]** mode page 73.

#### [1.3 SETTINGS] (SEt-) menu:

**[Mot. therm. current] (ItH)**

### Example of total return to factory settings

- [Config. Source] (FCS1) = [Macro-Conf] (In1)**
- [PARAMETER GROUP LIST] (FrY-) = [All] (ALL)**
- [Goto FACTORY SETTINGS] (GFS = YES)**

## [1.13 USER MENU] (USr-)

This menu contains the parameters selected in the [7 DISPLAY CONFIG.] menu on page 254.

**With graphic display terminal:**

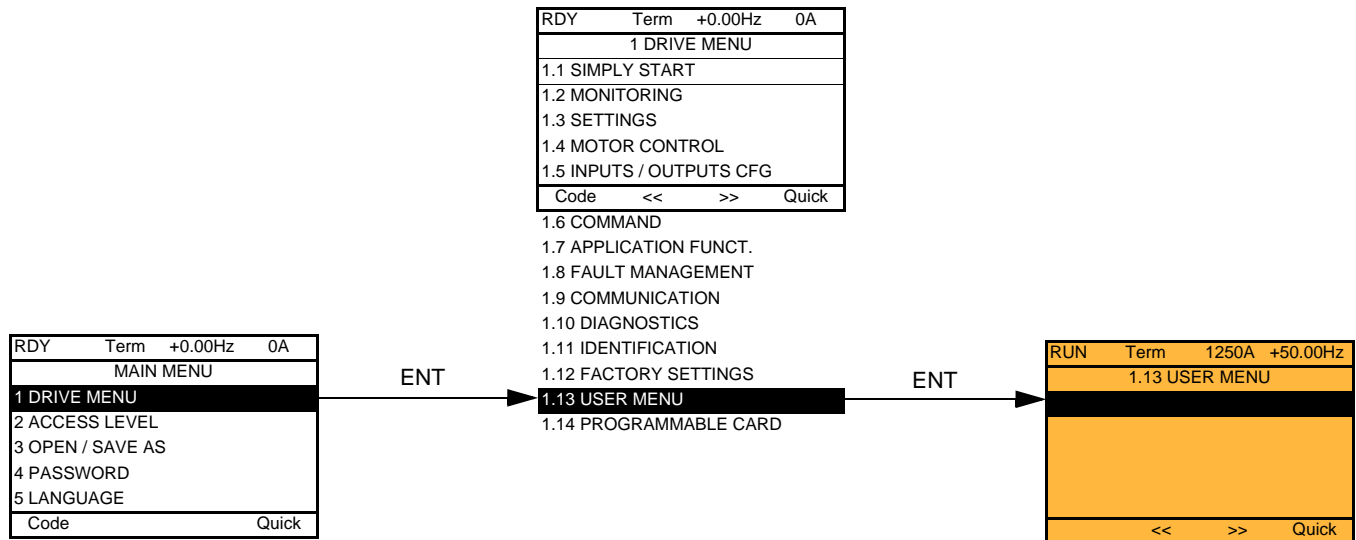

**With integrated display terminal:**

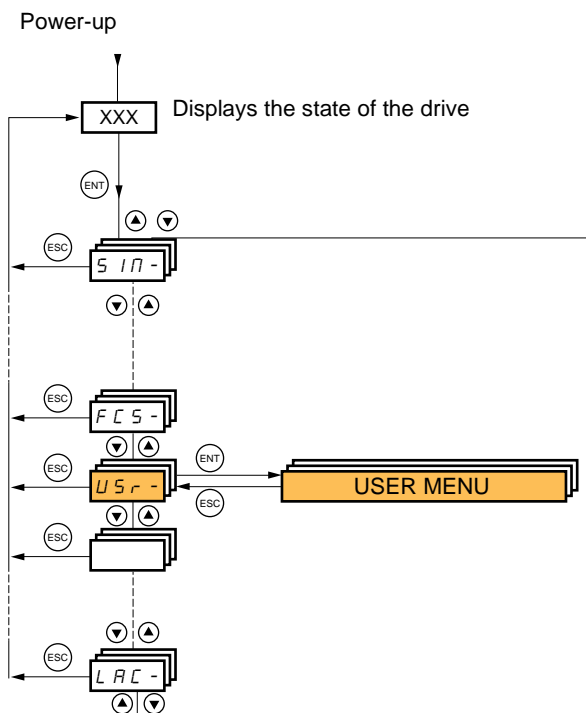



### [3. OPEN/SAVE AS]

This menu can only be accessed with the graphic display terminal.

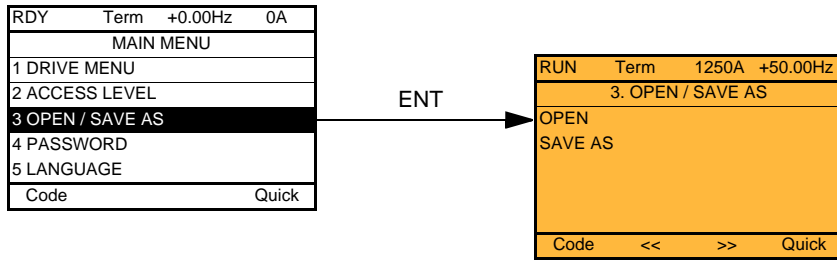

**[Open]:** To download one of the 4 files from the graphic display terminal to the drive.  
**[SAVE AS]:** To download the current drive configuration to the graphic display terminal.

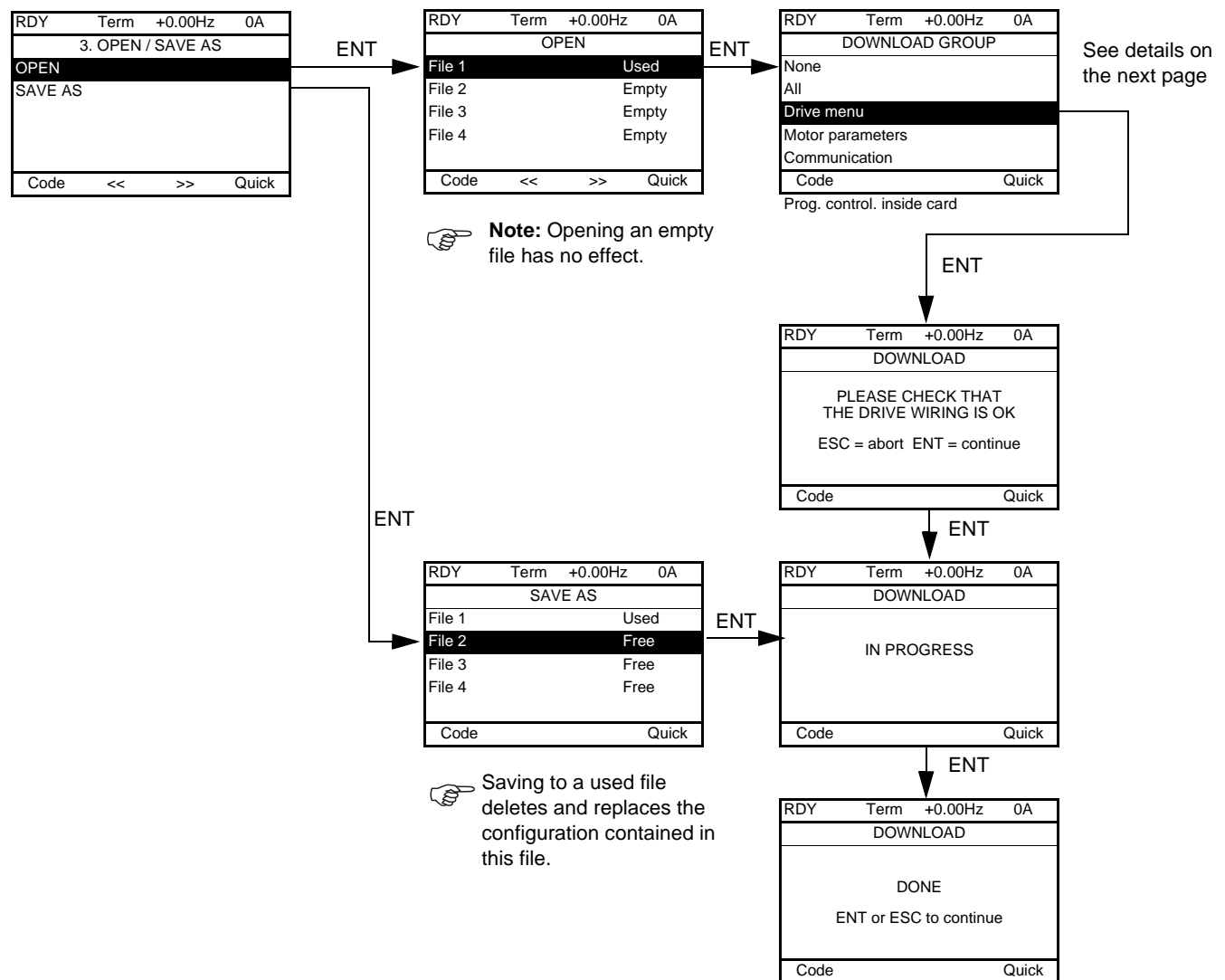

Various messages may appear when the download is requested:

- **[IN PROGRESS]**
- **[DONE]**
- Error messages if download not possible
- **[Motor parameters are NOT COMPATIBLE. Do you want to continue?]**: In this case the download is possible, but the parameters will be restricted.

### [3. OPEN/SAVE AS]

#### [DOWNLOAD GROUP]

|                                |   |  |
|--------------------------------|---|--|
| [None] :                       |   | No parameters  |
| [All]:                         |   | All parameters in all menus  |
| [Drive menu] :                 |   | The entire [1 DRIVE MENU] without [1.9 COMMUNICATION] and [1.14 PROGRAMMABLE CARD].    |
| [Motor parameters]:            | <p>[Rated motor power] (nPr)</p> <p>[Rated motor volt.] (UnS)</p> <p>[Rated mot. current] (nCr)</p> <p>[Rated motor freq.] (FrS)</p> <p>[Rated motor speed] (nSP)</p> <p>[Auto tuning] (tUn)</p> <p>[Auto tuning status] (tUS)</p> <p>[U0] (U0) to [U5] (U5)</p> <p>[F1] (F1) to [F5] (F5)</p> <p>[V. constant power] (UCP)</p> <p>[Freq. Const Power] (FCP)</p> <p>[Nominal I sync.] (nCrS)</p> <p>[Nom motor spdsync] (nSPS)</p> <p>[Pole pairs] (PPnS)</p> <p>[Syn. EMF constant] (PHS)</p> <p>[Autotune L d-axis] (LdS)</p> <p>[Autotune L q-axis] (LqS)</p> <p>[Cust. stator R syn] (rSAS)</p> <p>[IR compensation] (UFr)</p> <p>[Slip compensation] (SLP)</p> <p>The motor parameters that can be accessed in [Expert] mode, page 73</p> <p>[Mot. therm. current] (ItH)</p> | <p>in the [1.4 MOTOR CONTROL] (drC-) menu</p> <p>in the [1.3 SETTINGS] (SEt-) menu</p> |
| [Communication] :              |   | All the parameters in the [1.9 COMMUNICATION] menu                                     |
| [Prog. control. inside card] : |   | All the parameters in the [1.14 PROGRAMMABLE CARD] menu                                |

## [4. PASSWORD] (COd-)

With graphic display terminal:

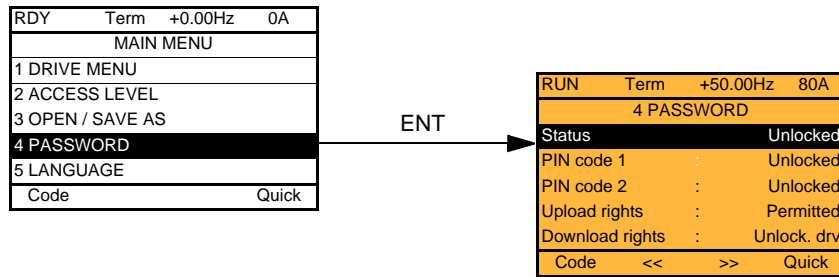

With integrated display terminal:

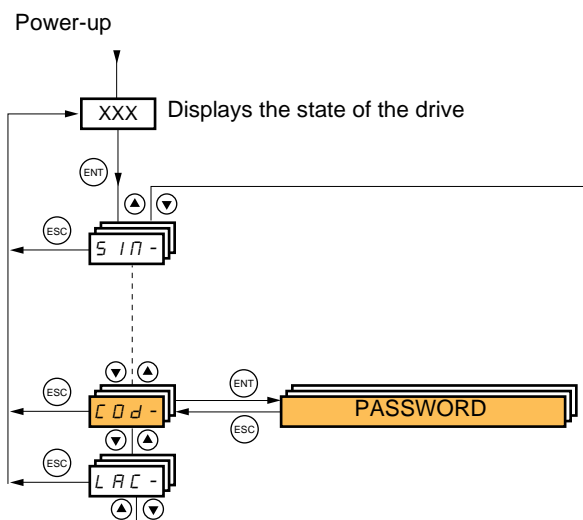

Enables the configuration to be protected with an access code or a password to be entered in order to access a protected configuration.

Example with graphic display terminal:

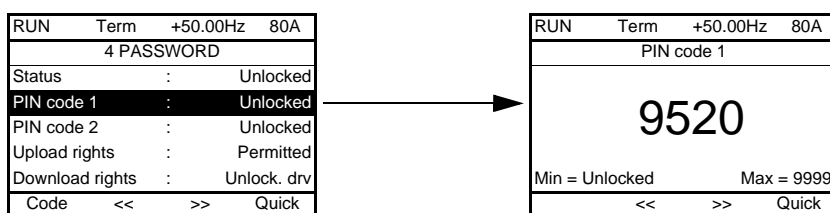

- The drive is unlocked when the PIN codes are set to **[unlocked] (OFF)** (no password) or when the correct code has been entered.
- Before protecting the configuration with an access code, you must:
  - Define the **[Upload rights] (ULr)** and **[Download rights] (dLr)**.
  - Make a careful note of the code and keep it in a safe place where you will always be able to find it.
- The drive has 2 access codes, enabling 2 access levels to be set up.
  - PIN code 1 is a public unlock code: 6969.
  - PIN code 2 is an unlock code known only to Schneider Electric Product Support. It can only be accessed in **[Expert]** mode.
  - Only one PIN1 or PIN2 code can be used - the other must remain set to **[OFF] (OFF)**.

**Note:** When the unlock code is entered, the user access code appears.

The following items are access-protected:

- Return to factory settings (**[1.12 FACTORY SETTINGS] (FCS-)** menu).
- The channels and parameters protected by the **[1.13 USER MENU]** as well as the menu itself.
- The custom display settings (**[7 DISPLAY CONFIG.]** menu).



## [4. PASSWORD] (COd-)

| Code   | Name/Description   | Adjustment range | Factory setting             |
|--|--|------------------|-----------------------------|
| <i>CSt</i><br><br><i>LC</i><br><i>ULC</i>  | <input type="checkbox"/> <b>[Status]</b><br><br>Information parameter, cannot be modified.<br><input type="checkbox"/> <b>[Locked] (LC)</b> : The drive is locked by a password.<br><input type="checkbox"/> <b>[Unlocked] (ULC)</b> : The drive is not locked by a password.  |                  | <b>[Unlocked] (ULC)</b>     |
| <i>COd</i>   | <input type="checkbox"/> <b>[PIN code 1]</b><br><br>1 <sup>st</sup> access code. The value <b>[OFF] (OFF)</b> indicates that no password has been set <b>[Unlocked]</b> . The value <b>[ON] (On)</b> indicates that the drive is protected and an access code must be entered in order to unlock it. Once the correct code has been entered, it remains on the display and the drive is unlocked until the next time the power supply is disconnected.<br>- PIN code 1 is a public unlock code: 6969.  | OFF to 9999      | <b>[OFF] (OFF)</b>          |
| <i>COd2</i>  | <input type="checkbox"/> <b>[PIN code 2]</b><br><br>Parameter can only be accessed in <b>[Expert]</b> mode.<br>2 <sup>nd</sup> access code. The value <b>[OFF] (OFF)</b> indicates that no password has been set <b>[Unlocked]</b> . The value <b>[ON] (On)</b> indicates that the drive is protected and an access code must be entered in order to unlock it. Once the correct code has been entered, it remains on the display and the drive is unlocked until the next time the power supply is disconnected.<br>- PIN code 2 is an unlock code known only to Schneider Electric Product Support.  | OFF to 9999      | <b>[OFF] (OFF)</b>          |
| <i>ULr</i><br><br><i>ULr0</i><br><br><i>ULr1</i>                                       | <input type="checkbox"/> <b>[Upload rights]</b><br><br>Read or copy the current configuration to the drive.<br><input type="checkbox"/> <b>[Permitted] (ULr0)</b> : The current drive configuration can always be uploaded to the graphic display terminal or PowerSuite.<br><input type="checkbox"/> <b>[Not allowed] (ULr1)</b> : The current drive configuration can only be uploaded to the graphic display terminal or PowerSuite if the drive is not protected by an access code or if the correct code has been entered.  |                  | <b>[Permitted] (ULr0)</b>   |
| <i>dLr</i><br><br><i>dLr0</i><br><br><i>dLr1</i><br><br><i>dLr2</i><br><br><i>dLr3</i> | <input type="checkbox"/> <b>[Download rights]</b><br><br>Writes the current configuration to the drive or downloads a configuration to the drive<br><input type="checkbox"/> <b>[Locked drv] (dLr0)</b> : A configuration file can only be downloaded to the drive if the drive is protected by an access code, which is the same as the access code for the configuration to be downloaded.<br><input type="checkbox"/> <b>[Unlock. drv] (dLr1)</b> : A configuration file can be downloaded to the drive or a configuration in the drive can be modified if the drive is unlocked (access code entered) or is not protected by an access code.<br><input type="checkbox"/> <b>[Not allowed] (dLr2)</b> : Download not authorized.<br><input type="checkbox"/> <b>[Lock/unlock] (dLr3)</b> : Combination of <b>[Locked drv.] (dLr0)</b> and <b>[Unlock. drv] (dLr1)</b> . |                  | <b>[Unlock. drv] (dLr1)</b> |

## [6 MONITORING CONFIG.]

This menu can only be accessed with the graphic display terminal.

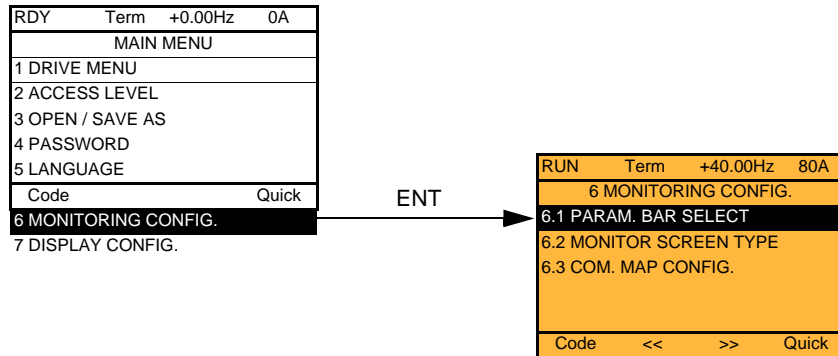

This can be used to configure the information displayed on the graphic display screen during operation.

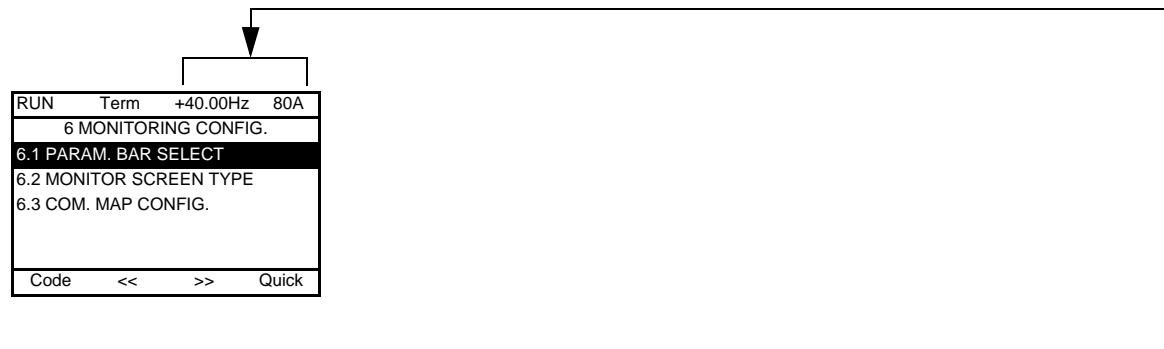

[6.1. PARAM. BAR SELECT]: Selection of 1 to 2 parameters displayed on the top line (the first 2 cannot be modified).

[6.2. MONITOR SCREEN TYPE]: Selection of parameters displayed in the centre of the screen and the display mode (digital values or bar graph format).

[6.3. COM. MAP CONFIG.]: Selection of the words displayed and their format.

# [6 MONITORING CONFIG.]

Name/Description

## ■ [6.1 PARAM. BAR SELECT]

- [Alarm groups]
- [Frequency ref.] in Hz: parameter displayed in factory configuration.
- [Torque reference] as a %
- [Output frequency] in Hz
- [Motor current] in A: parameter displayed in factory configuration.
- [ENA avg speed] in Hz
- [Motor speed] in rpm
- [Motor voltage] in V
- [Motor power] in W
- [Motor torque] as a %
- [Mains voltage] in V
- [Motor thermal state] as a %
- [Drv. thermal state] as a %
- [DBR thermal state] as a %
- [Consumption] in Wh or kWh depending on drive rating
- [Run time] in hours (length of time the motor has been switched on)
- [Power on time] in hours (length of time the drive has been switched on)
- [IGBT alarm counter] in seconds (total time of IGBT overheating alarms)
- [PID reference] as a %
- [PID feedback] as a %
- [PID error] as a %
- [PID Output] in Hz
- [- - - - 02] Word generated by the Controller Inside card (can be accessed if the card has been inserted)  
to
- [- - - - 06] Word generated by the Controller Inside card (can be accessed if the card has been inserted)
- [Config. active] CNFO, 1 or 2 (see page [197](#))
- [Utilised param. set] SET1, 2 or 3 (see page [195](#))

Select the parameter using ENT (a  then appears next to the parameter). Parameter(s) can also be deselected using ENT. 1 or 2 parameters can be selected.

Example:

| PARAM. BAR SELECT |                                     |
|-------------------|-------------------------------------|
| MONITORING        |                                     |
| -----             | <input checked="" type="checkbox"/> |
| -----             | <input type="checkbox"/>            |
| -----             | <input type="checkbox"/>            |
| -----             | <input checked="" type="checkbox"/> |

# [6 MONITORING CONFIG.]

| Name/Description  |               |                     |      |            |     |             |   |       |  |          |  |       |   |               |  |  |  |      |  |  |  |       |  |  |  |     |      |          |     |     |             |     |  |   |          |      |  |  |  |  |  |     |               |     |  |   |      |     |  |  |  |  |  |       |  |  |  |     |      |          |     |            |  |  |  |                |   |        |  |                |  |      |  |              |  |          |  |                      |  |     |  |                   |   |     |  |       |  |  |  |
|---|---------------|---------------------|------|------------|-----|-------------|---|-------|--|----------|--|-------|---|---------------|--|--|--|------|--|--|--|-------|--|--|--|-----|------|----------|-----|-----|-------------|-----|--|---|----------|------|--|--|--|--|--|-----|---------------|-----|--|---|------|-----|--|--|--|--|--|-------|--|--|--|-----|------|----------|-----|------------|--|--|--|----------------|---|--------|--|----------------|--|------|--|--------------|--|----------|--|----------------------|--|-----|--|-------------------|---|-----|--|-------|--|--|--|
| <b>■ [6.2. MONITOR SCREEN TYPE]</b>   |               |                     |      |            |     |             |   |       |  |          |  |       |   |               |  |  |  |      |  |  |  |       |  |  |  |     |      |          |     |     |             |     |  |   |          |      |  |  |  |  |  |     |               |     |  |   |      |     |  |  |  |  |  |       |  |  |  |     |      |          |     |            |  |  |  |                |   |        |  |                |  |      |  |              |  |          |  |                      |  |     |  |                   |   |     |  |       |  |  |  |
| <input type="checkbox"/> <b>[Display value type]</b> <ul style="list-style-type: none"> <li><input type="checkbox"/> <b>[Digital]</b>: Display of one or two digital values on the screen (factory configuration).</li> <li><input type="checkbox"/> <b>[Bar graph]</b>: Display of one or two bar graphs on the screen.</li> <li><input type="checkbox"/> <b>[List]</b>: Display a list of between one and five values on the screen.</li> </ul>   |               |                     |      |            |     |             |   |       |  |          |  |       |   |               |  |  |  |      |  |  |  |       |  |  |  |     |      |          |     |     |             |     |  |   |          |      |  |  |  |  |  |     |               |     |  |   |      |     |  |  |  |  |  |       |  |  |  |     |      |          |     |            |  |  |  |                |   |        |  |                |  |      |  |              |  |          |  |                      |  |     |  |                   |   |     |  |       |  |  |  |
| <input type="checkbox"/> <b>[PARAMETER SELECTION]</b> <ul style="list-style-type: none"> <li><input type="checkbox"/> <b>[Alarm groups]</b> can only be accessed if <b>[Display value type]</b> = <b>[List]</b></li> <li><input type="checkbox"/> <b>[Frequency ref.]</b> in Hz: parameter displayed in factory configuration.</li> <li><input type="checkbox"/> <b>[Torque reference]</b> as a %</li> <li><input type="checkbox"/> <b>[Output frequency]</b> in Hz</li> <li><input type="checkbox"/> <b>[Motor current]</b> in A</li> <li><input type="checkbox"/> <b>[ENA avg speed]</b> in Hz</li> <li><input type="checkbox"/> <b>[Motor speed]</b> in rpm</li> <li><input type="checkbox"/> <b>[Motor voltage]</b> in V</li> <li><input type="checkbox"/> <b>[Motor power]</b> in W</li> <li><input type="checkbox"/> <b>[Motor torque]</b> as a %</li> <li><input type="checkbox"/> <b>[Mains voltage]</b> in V</li> <li><input type="checkbox"/> <b>[Motor thermal state]</b> as a %</li> <li><input type="checkbox"/> <b>[Drv. thermal state]</b> as a %</li> <li><input type="checkbox"/> <b>[DBR thermal state]</b> as a %</li> <li><input type="checkbox"/> <b>[Consumption]</b> in Wh or kWh depending on drive rating</li> <li><input type="checkbox"/> <b>[Run time]</b> in hours (length of time the motor has been switched on)</li> <li><input type="checkbox"/> <b>[Power on time]</b> in hours (length of time the drive has been switched on)</li> <li><input type="checkbox"/> <b>[IGBT alarm counter]</b> in seconds (total time of IGBT overheating alarms)</li> <li><input type="checkbox"/> <b>[PID reference]</b> as a %</li> <li><input type="checkbox"/> <b>[PID feedback]</b> as a %</li> <li><input type="checkbox"/> <b>[PID error]</b> as a %</li> <li><input type="checkbox"/> <b>[PID Output]</b> in Hz</li> <li><input type="checkbox"/> <b>[- - - - 02]</b> Word generated by the Controller Inside card (can be accessed if the card has been inserted)</li> <li>to</li> <li><input type="checkbox"/> <b>[- - - - 06]</b> Word generated by the Controller Inside card (can be accessed if the card has been inserted)</li> <li><input type="checkbox"/> <b>[Config. active]</b> CNFO, 1 or 2 (see page 197), can only be accessed if <b>[Display value type]</b> = <b>[List]</b></li> <li><input type="checkbox"/> <b>[Utilised param. set]</b> SET1, 2 or 3 (see page 195), can only be accessed if <b>[Display value type]</b> = <b>[List]</b></li> </ul> <p>Select the parameter(s) using ENT (a <input checked="" type="checkbox"/> then appears next to the parameter). Parameter(s) can also be deselected using ENT.</p> |               |                     |      |            |     |             |   |       |  |          |  |       |   |               |  |  |  |      |  |  |  |       |  |  |  |     |      |          |     |     |             |     |  |   |          |      |  |  |  |  |  |     |               |     |  |   |      |     |  |  |  |  |  |       |  |  |  |     |      |          |     |            |  |  |  |                |   |        |  |                |  |      |  |              |  |          |  |                      |  |     |  |                   |   |     |  |       |  |  |  |
| <table border="1" style="width: 100%; border-collapse: collapse;"> <thead> <tr> <th colspan="2">PARAMETER SELECTION</th> </tr> </thead> <tbody> <tr> <td colspan="2" style="text-align: center;">MONITORING</td> </tr> <tr> <td>-----</td> <td style="text-align: right;">✓</td> </tr> <tr> <td>-----</td> <td></td> </tr> <tr> <td>-----</td> <td></td> </tr> <tr> <td>-----</td> <td style="text-align: right;">✓</td> </tr> </tbody> </table>  |               | PARAMETER SELECTION |      | MONITORING |     | -----       | ✓ | ----- |  | -----    |  | ----- | ✓ |               |  |  |  |      |  |  |  |       |  |  |  |     |      |          |     |     |             |     |  |   |          |      |  |  |  |  |  |     |               |     |  |   |      |     |  |  |  |  |  |       |  |  |  |     |      |          |     |            |  |  |  |                |   |        |  |                |  |      |  |              |  |          |  |                      |  |     |  |                   |   |     |  |       |  |  |  |
| PARAMETER SELECTION   |               |                     |      |            |     |             |   |       |  |          |  |       |   |               |  |  |  |      |  |  |  |       |  |  |  |     |      |          |     |     |             |     |  |   |          |      |  |  |  |  |  |     |               |     |  |   |      |     |  |  |  |  |  |       |  |  |  |     |      |          |     |            |  |  |  |                |   |        |  |                |  |      |  |              |  |          |  |                      |  |     |  |                   |   |     |  |       |  |  |  |
| MONITORING  |               |                     |      |            |     |             |   |       |  |          |  |       |   |               |  |  |  |      |  |  |  |       |  |  |  |     |      |          |     |     |             |     |  |   |          |      |  |  |  |  |  |     |               |     |  |   |      |     |  |  |  |  |  |       |  |  |  |     |      |          |     |            |  |  |  |                |   |        |  |                |  |      |  |              |  |          |  |                      |  |     |  |                   |   |     |  |       |  |  |  |
| -----   | ✓             |                     |      |            |     |             |   |       |  |          |  |       |   |               |  |  |  |      |  |  |  |       |  |  |  |     |      |          |     |     |             |     |  |   |          |      |  |  |  |  |  |     |               |     |  |   |      |     |  |  |  |  |  |       |  |  |  |     |      |          |     |            |  |  |  |                |   |        |  |                |  |      |  |              |  |          |  |                      |  |     |  |                   |   |     |  |       |  |  |  |
| -----   |               |                     |      |            |     |             |   |       |  |          |  |       |   |               |  |  |  |      |  |  |  |       |  |  |  |     |      |          |     |     |             |     |  |   |          |      |  |  |  |  |  |     |               |     |  |   |      |     |  |  |  |  |  |       |  |  |  |     |      |          |     |            |  |  |  |                |   |        |  |                |  |      |  |              |  |          |  |                      |  |     |  |                   |   |     |  |       |  |  |  |
| -----   |               |                     |      |            |     |             |   |       |  |          |  |       |   |               |  |  |  |      |  |  |  |       |  |  |  |     |      |          |     |     |             |     |  |   |          |      |  |  |  |  |  |     |               |     |  |   |      |     |  |  |  |  |  |       |  |  |  |     |      |          |     |            |  |  |  |                |   |        |  |                |  |      |  |              |  |          |  |                      |  |     |  |                   |   |     |  |       |  |  |  |
| -----   | ✓             |                     |      |            |     |             |   |       |  |          |  |       |   |               |  |  |  |      |  |  |  |       |  |  |  |     |      |          |     |     |             |     |  |   |          |      |  |  |  |  |  |     |               |     |  |   |      |     |  |  |  |  |  |       |  |  |  |     |      |          |     |            |  |  |  |                |   |        |  |                |  |      |  |              |  |          |  |                      |  |     |  |                   |   |     |  |       |  |  |  |
| <p>Examples include:</p> <div style="display: flex; justify-content: space-around;"> <div style="text-align: center;"> <p>Display of 2 digital values</p> <table border="1" style="width: 100%; border-collapse: collapse;"> <thead> <tr> <th>RUN</th> <th>Term</th> <th>+35.00Hz</th> <th>80A</th> </tr> </thead> <tbody> <tr> <td colspan="4" style="text-align: center;">Motor speed</td> </tr> <tr> <td colspan="4" style="text-align: center; font-size: 24px;">1250 rpm</td> </tr> <tr> <td colspan="4" style="text-align: center;">Motor current</td> </tr> <tr> <td colspan="4" style="text-align: center; font-size: 24px;">80 A</td> </tr> <tr> <td colspan="4" style="text-align: right;">Quick</td> </tr> </tbody> </table> </div> <div style="text-align: center;"> <p>Display of 2 bar graphs</p> <table border="1" style="width: 100%; border-collapse: collapse;"> <thead> <tr> <th>RUN</th> <th>Term</th> <th>+35.00Hz</th> <th>80A</th> </tr> </thead> <tbody> <tr> <td>Min</td> <td>Motor speed</td> <td colspan="2">max</td> </tr> <tr> <td>0</td> <td>1250 rpm</td> <td colspan="2">1500</td> </tr> <tr> <td colspan="4" style="text-align: center;"> </td> </tr> <tr> <td>Min</td> <td>Motor current</td> <td colspan="2">max</td> </tr> <tr> <td>0</td> <td>80 A</td> <td colspan="2">150</td> </tr> <tr> <td colspan="4" style="text-align: center;"> </td> </tr> <tr> <td colspan="4" style="text-align: right;">Quick</td> </tr> </tbody> </table> </div> <div style="text-align: center;"> <p>Display of a list of 5 values</p> <table border="1" style="width: 100%; border-collapse: collapse;"> <thead> <tr> <th>RUN</th> <th>Term</th> <th>+35.00Hz</th> <th>80A</th> </tr> </thead> <tbody> <tr> <td colspan="4" style="text-align: center;">MONITORING</td> </tr> <tr> <td>Frequency ref.</td> <td>:</td> <td colspan="2">50.1Hz</td> </tr> <tr> <td>Motor current:</td> <td></td> <td colspan="2">80 A</td> </tr> <tr> <td>Motor speed:</td> <td></td> <td colspan="2">1250 rpm</td> </tr> <tr> <td>Motor thermal state:</td> <td></td> <td colspan="2">80%</td> </tr> <tr> <td>Drv thermal state</td> <td>:</td> <td colspan="2">80%</td> </tr> <tr> <td colspan="4" style="text-align: right;">Quick</td> </tr> </tbody> </table> </div> </div>   |               | RUN                 | Term | +35.00Hz   | 80A | Motor speed |   |       |  | 1250 rpm |  |       |   | Motor current |  |  |  | 80 A |  |  |  | Quick |  |  |  | RUN | Term | +35.00Hz | 80A | Min | Motor speed | max |  | 0 | 1250 rpm | 1500 |  |  |  |  |  | Min | Motor current | max |  | 0 | 80 A | 150 |  |  |  |  |  | Quick |  |  |  | RUN | Term | +35.00Hz | 80A | MONITORING |  |  |  | Frequency ref. | : | 50.1Hz |  | Motor current: |  | 80 A |  | Motor speed: |  | 1250 rpm |  | Motor thermal state: |  | 80% |  | Drv thermal state | : | 80% |  | Quick |  |  |  |
| RUN   | Term          | +35.00Hz            | 80A  |            |     |             |   |       |  |          |  |       |   |               |  |  |  |      |  |  |  |       |  |  |  |     |      |          |     |     |             |     |  |   |          |      |  |  |  |  |  |     |               |     |  |   |      |     |  |  |  |  |  |       |  |  |  |     |      |          |     |            |  |  |  |                |   |        |  |                |  |      |  |              |  |          |  |                      |  |     |  |                   |   |     |  |       |  |  |  |
| Motor speed   |               |                     |      |            |     |             |   |       |  |          |  |       |   |               |  |  |  |      |  |  |  |       |  |  |  |     |      |          |     |     |             |     |  |   |          |      |  |  |  |  |  |     |               |     |  |   |      |     |  |  |  |  |  |       |  |  |  |     |      |          |     |            |  |  |  |                |   |        |  |                |  |      |  |              |  |          |  |                      |  |     |  |                   |   |     |  |       |  |  |  |
| 1250 rpm  |               |                     |      |            |     |             |   |       |  |          |  |       |   |               |  |  |  |      |  |  |  |       |  |  |  |     |      |          |     |     |             |     |  |   |          |      |  |  |  |  |  |     |               |     |  |   |      |     |  |  |  |  |  |       |  |  |  |     |      |          |     |            |  |  |  |                |   |        |  |                |  |      |  |              |  |          |  |                      |  |     |  |                   |   |     |  |       |  |  |  |
| Motor current   |               |                     |      |            |     |             |   |       |  |          |  |       |   |               |  |  |  |      |  |  |  |       |  |  |  |     |      |          |     |     |             |     |  |   |          |      |  |  |  |  |  |     |               |     |  |   |      |     |  |  |  |  |  |       |  |  |  |     |      |          |     |            |  |  |  |                |   |        |  |                |  |      |  |              |  |          |  |                      |  |     |  |                   |   |     |  |       |  |  |  |
| 80 A  |               |                     |      |            |     |             |   |       |  |          |  |       |   |               |  |  |  |      |  |  |  |       |  |  |  |     |      |          |     |     |             |     |  |   |          |      |  |  |  |  |  |     |               |     |  |   |      |     |  |  |  |  |  |       |  |  |  |     |      |          |     |            |  |  |  |                |   |        |  |                |  |      |  |              |  |          |  |                      |  |     |  |                   |   |     |  |       |  |  |  |
| Quick   |               |                     |      |            |     |             |   |       |  |          |  |       |   |               |  |  |  |      |  |  |  |       |  |  |  |     |      |          |     |     |             |     |  |   |          |      |  |  |  |  |  |     |               |     |  |   |      |     |  |  |  |  |  |       |  |  |  |     |      |          |     |            |  |  |  |                |   |        |  |                |  |      |  |              |  |          |  |                      |  |     |  |                   |   |     |  |       |  |  |  |
| RUN   | Term          | +35.00Hz            | 80A  |            |     |             |   |       |  |          |  |       |   |               |  |  |  |      |  |  |  |       |  |  |  |     |      |          |     |     |             |     |  |   |          |      |  |  |  |  |  |     |               |     |  |   |      |     |  |  |  |  |  |       |  |  |  |     |      |          |     |            |  |  |  |                |   |        |  |                |  |      |  |              |  |          |  |                      |  |     |  |                   |   |     |  |       |  |  |  |
| Min   | Motor speed   | max                 |      |            |     |             |   |       |  |          |  |       |   |               |  |  |  |      |  |  |  |       |  |  |  |     |      |          |     |     |             |     |  |   |          |      |  |  |  |  |  |     |               |     |  |   |      |     |  |  |  |  |  |       |  |  |  |     |      |          |     |            |  |  |  |                |   |        |  |                |  |      |  |              |  |          |  |                      |  |     |  |                   |   |     |  |       |  |  |  |
| 0   | 1250 rpm      | 1500                |      |            |     |             |   |       |  |          |  |       |   |               |  |  |  |      |  |  |  |       |  |  |  |     |      |          |     |     |             |     |  |   |          |      |  |  |  |  |  |     |               |     |  |   |      |     |  |  |  |  |  |       |  |  |  |     |      |          |     |            |  |  |  |                |   |        |  |                |  |      |  |              |  |          |  |                      |  |     |  |                   |   |     |  |       |  |  |  |
|   |               |                     |      |            |     |             |   |       |  |          |  |       |   |               |  |  |  |      |  |  |  |       |  |  |  |     |      |          |     |     |             |     |  |   |          |      |  |  |  |  |  |     |               |     |  |   |      |     |  |  |  |  |  |       |  |  |  |     |      |          |     |            |  |  |  |                |   |        |  |                |  |      |  |              |  |          |  |                      |  |     |  |                   |   |     |  |       |  |  |  |
| Min   | Motor current | max                 |      |            |     |             |   |       |  |          |  |       |   |               |  |  |  |      |  |  |  |       |  |  |  |     |      |          |     |     |             |     |  |   |          |      |  |  |  |  |  |     |               |     |  |   |      |     |  |  |  |  |  |       |  |  |  |     |      |          |     |            |  |  |  |                |   |        |  |                |  |      |  |              |  |          |  |                      |  |     |  |                   |   |     |  |       |  |  |  |
| 0   | 80 A          | 150                 |      |            |     |             |   |       |  |          |  |       |   |               |  |  |  |      |  |  |  |       |  |  |  |     |      |          |     |     |             |     |  |   |          |      |  |  |  |  |  |     |               |     |  |   |      |     |  |  |  |  |  |       |  |  |  |     |      |          |     |            |  |  |  |                |   |        |  |                |  |      |  |              |  |          |  |                      |  |     |  |                   |   |     |  |       |  |  |  |
|   |               |                     |      |            |     |             |   |       |  |          |  |       |   |               |  |  |  |      |  |  |  |       |  |  |  |     |      |          |     |     |             |     |  |   |          |      |  |  |  |  |  |     |               |     |  |   |      |     |  |  |  |  |  |       |  |  |  |     |      |          |     |            |  |  |  |                |   |        |  |                |  |      |  |              |  |          |  |                      |  |     |  |                   |   |     |  |       |  |  |  |
| Quick   |               |                     |      |            |     |             |   |       |  |          |  |       |   |               |  |  |  |      |  |  |  |       |  |  |  |     |      |          |     |     |             |     |  |   |          |      |  |  |  |  |  |     |               |     |  |   |      |     |  |  |  |  |  |       |  |  |  |     |      |          |     |            |  |  |  |                |   |        |  |                |  |      |  |              |  |          |  |                      |  |     |  |                   |   |     |  |       |  |  |  |
| RUN   | Term          | +35.00Hz            | 80A  |            |     |             |   |       |  |          |  |       |   |               |  |  |  |      |  |  |  |       |  |  |  |     |      |          |     |     |             |     |  |   |          |      |  |  |  |  |  |     |               |     |  |   |      |     |  |  |  |  |  |       |  |  |  |     |      |          |     |            |  |  |  |                |   |        |  |                |  |      |  |              |  |          |  |                      |  |     |  |                   |   |     |  |       |  |  |  |
| MONITORING  |               |                     |      |            |     |             |   |       |  |          |  |       |   |               |  |  |  |      |  |  |  |       |  |  |  |     |      |          |     |     |             |     |  |   |          |      |  |  |  |  |  |     |               |     |  |   |      |     |  |  |  |  |  |       |  |  |  |     |      |          |     |            |  |  |  |                |   |        |  |                |  |      |  |              |  |          |  |                      |  |     |  |                   |   |     |  |       |  |  |  |
| Frequency ref.  | :             | 50.1Hz              |      |            |     |             |   |       |  |          |  |       |   |               |  |  |  |      |  |  |  |       |  |  |  |     |      |          |     |     |             |     |  |   |          |      |  |  |  |  |  |     |               |     |  |   |      |     |  |  |  |  |  |       |  |  |  |     |      |          |     |            |  |  |  |                |   |        |  |                |  |      |  |              |  |          |  |                      |  |     |  |                   |   |     |  |       |  |  |  |
| Motor current:  |               | 80 A                |      |            |     |             |   |       |  |          |  |       |   |               |  |  |  |      |  |  |  |       |  |  |  |     |      |          |     |     |             |     |  |   |          |      |  |  |  |  |  |     |               |     |  |   |      |     |  |  |  |  |  |       |  |  |  |     |      |          |     |            |  |  |  |                |   |        |  |                |  |      |  |              |  |          |  |                      |  |     |  |                   |   |     |  |       |  |  |  |
| Motor speed:  |               | 1250 rpm            |      |            |     |             |   |       |  |          |  |       |   |               |  |  |  |      |  |  |  |       |  |  |  |     |      |          |     |     |             |     |  |   |          |      |  |  |  |  |  |     |               |     |  |   |      |     |  |  |  |  |  |       |  |  |  |     |      |          |     |            |  |  |  |                |   |        |  |                |  |      |  |              |  |          |  |                      |  |     |  |                   |   |     |  |       |  |  |  |
| Motor thermal state:  |               | 80%                 |      |            |     |             |   |       |  |          |  |       |   |               |  |  |  |      |  |  |  |       |  |  |  |     |      |          |     |     |             |     |  |   |          |      |  |  |  |  |  |     |               |     |  |   |      |     |  |  |  |  |  |       |  |  |  |     |      |          |     |            |  |  |  |                |   |        |  |                |  |      |  |              |  |          |  |                      |  |     |  |                   |   |     |  |       |  |  |  |
| Drv thermal state   | :             | 80%                 |      |            |     |             |   |       |  |          |  |       |   |               |  |  |  |      |  |  |  |       |  |  |  |     |      |          |     |     |             |     |  |   |          |      |  |  |  |  |  |     |               |     |  |   |      |     |  |  |  |  |  |       |  |  |  |     |      |          |     |            |  |  |  |                |   |        |  |                |  |      |  |              |  |          |  |                      |  |     |  |                   |   |     |  |       |  |  |  |
| Quick   |               |                     |      |            |     |             |   |       |  |          |  |       |   |               |  |  |  |      |  |  |  |       |  |  |  |     |      |          |     |     |             |     |  |   |          |      |  |  |  |  |  |     |               |     |  |   |      |     |  |  |  |  |  |       |  |  |  |     |      |          |     |            |  |  |  |                |   |        |  |                |  |      |  |              |  |          |  |                      |  |     |  |                   |   |     |  |       |  |  |  |

## [6 MONITORING CONFIG.]

| Name/Description  |          |          |          |     |                   |  |  |  |       |  |  |  |       |  |  |  |        |          |  |  |       |  |  |  |    |  |    |  |  |  |       |  |
|---|----------|----------|----------|-----|-------------------|--|--|--|-------|--|--|--|-------|--|--|--|--------|----------|--|--|-------|--|--|--|----|--|----|--|--|--|-------|--|
| <b>■ [6.3. COM. MAP CONFIG.]</b>  |          |          |          |     |                   |  |  |  |       |  |  |  |       |  |  |  |        |          |  |  |       |  |  |  |    |  |    |  |  |  |       |  |
| <input type="checkbox"/> <b>[Word 1 add. select.]</b><br>Select the address of the word to be displayed by pressing the <<, >> (F2 and F3) keys and rotating the navigation button.   |          |          |          |     |                   |  |  |  |       |  |  |  |       |  |  |  |        |          |  |  |       |  |  |  |    |  |    |  |  |  |       |  |
| <input type="checkbox"/> <b>[Format word 1]</b><br>Format of word 1.<br><input type="checkbox"/> <b>[Hex]</b> : Hexadecimal<br><input type="checkbox"/> <b>[Signed]</b> : Decimal with sign<br><input type="checkbox"/> <b>[Unsigned]</b> : Decimal without sign  |          |          |          |     |                   |  |  |  |       |  |  |  |       |  |  |  |        |          |  |  |       |  |  |  |    |  |    |  |  |  |       |  |
| <input type="checkbox"/> <b>[Word 2 add. select.]</b><br>Select the address of the word to be displayed by pressing the <<, >> (F2 and F3) keys and rotating the navigation button.   |          |          |          |     |                   |  |  |  |       |  |  |  |       |  |  |  |        |          |  |  |       |  |  |  |    |  |    |  |  |  |       |  |
| <input type="checkbox"/> <b>[Format word 2]</b><br>Format of word 2.<br><input type="checkbox"/> <b>[Hex]</b> : Hexadecimal<br><input type="checkbox"/> <b>[Signed]</b> : Decimal with sign<br><input type="checkbox"/> <b>[Unsigned]</b> : Decimal without sign  |          |          |          |     |                   |  |  |  |       |  |  |  |       |  |  |  |        |          |  |  |       |  |  |  |    |  |    |  |  |  |       |  |
| <input type="checkbox"/> <b>[Word 3 add. select.]</b><br>Select the address of the word to be displayed by pressing the <<, >> (F2 and F3) keys and rotating the navigation button.   |          |          |          |     |                   |  |  |  |       |  |  |  |       |  |  |  |        |          |  |  |       |  |  |  |    |  |    |  |  |  |       |  |
| <input type="checkbox"/> <b>[Format word 3]</b><br>Format of word 3.<br><input type="checkbox"/> <b>[Hex]</b> : Hexadecimal<br><input type="checkbox"/> <b>[Signed]</b> : Decimal with sign<br><input type="checkbox"/> <b>[Unsigned]</b> : Decimal without sign  |          |          |          |     |                   |  |  |  |       |  |  |  |       |  |  |  |        |          |  |  |       |  |  |  |    |  |    |  |  |  |       |  |
| <input type="checkbox"/> <b>[Word 4 add. select.]</b><br>Select the address of the word to be displayed by pressing the <<, >> (F2 and F3) keys and rotating the navigation button.   |          |          |          |     |                   |  |  |  |       |  |  |  |       |  |  |  |        |          |  |  |       |  |  |  |    |  |    |  |  |  |       |  |
| <input type="checkbox"/> <b>[Format word 4]</b><br>Format of word 4.<br><input type="checkbox"/> <b>[Hex]</b> : Hexadecimal<br><input type="checkbox"/> <b>[Signed]</b> : Decimal with sign<br><input type="checkbox"/> <b>[Unsigned]</b> : Decimal without sign  |          |          |          |     |                   |  |  |  |       |  |  |  |       |  |  |  |        |          |  |  |       |  |  |  |    |  |    |  |  |  |       |  |
| It will then be possible to view the selected words in the <b>[COMMUNICATION MAP]</b> submenu of the <b>[1.2 MONITORING]</b> menu.<br>Example:  |          |          |          |     |                   |  |  |  |       |  |  |  |       |  |  |  |        |          |  |  |       |  |  |  |    |  |    |  |  |  |       |  |
| <table border="1"><tr><td>RUN</td><td>Term</td><td>+35.00Hz</td><td>80A</td></tr><tr><td colspan="4">COMMUNICATION MAP</td></tr><tr><td colspan="4">-----</td></tr><tr><td colspan="4">-----</td></tr><tr><td>W3141:</td><td colspan="3">F230 Hex</td></tr><tr><td colspan="4">-----</td></tr><tr><td colspan="2">&lt;&lt;</td><td colspan="2">&gt;&gt;</td></tr><tr><td colspan="2"></td><td colspan="2">Quick</td></tr></table> | RUN      | Term     | +35.00Hz | 80A | COMMUNICATION MAP |  |  |  | ----- |  |  |  | ----- |  |  |  | W3141: | F230 Hex |  |  | ----- |  |  |  | << |  | >> |  |  |  | Quick |  |
| RUN   | Term     | +35.00Hz | 80A      |     |                   |  |  |  |       |  |  |  |       |  |  |  |        |          |  |  |       |  |  |  |    |  |    |  |  |  |       |  |
| COMMUNICATION MAP   |          |          |          |     |                   |  |  |  |       |  |  |  |       |  |  |  |        |          |  |  |       |  |  |  |    |  |    |  |  |  |       |  |
| -----   |          |          |          |     |                   |  |  |  |       |  |  |  |       |  |  |  |        |          |  |  |       |  |  |  |    |  |    |  |  |  |       |  |
| -----   |          |          |          |     |                   |  |  |  |       |  |  |  |       |  |  |  |        |          |  |  |       |  |  |  |    |  |    |  |  |  |       |  |
| W3141:  | F230 Hex |          |          |     |                   |  |  |  |       |  |  |  |       |  |  |  |        |          |  |  |       |  |  |  |    |  |    |  |  |  |       |  |
| -----   |          |          |          |     |                   |  |  |  |       |  |  |  |       |  |  |  |        |          |  |  |       |  |  |  |    |  |    |  |  |  |       |  |
| <<  |          | >>       |          |     |                   |  |  |  |       |  |  |  |       |  |  |  |        |          |  |  |       |  |  |  |    |  |    |  |  |  |       |  |
|   |          | Quick    |          |     |                   |  |  |  |       |  |  |  |       |  |  |  |        |          |  |  |       |  |  |  |    |  |    |  |  |  |       |  |

## [7 DISPLAY CONFIG.]

---

This menu can only be accessed with the graphic display terminal. It can be used to customize parameters or a menu and to access parameters.

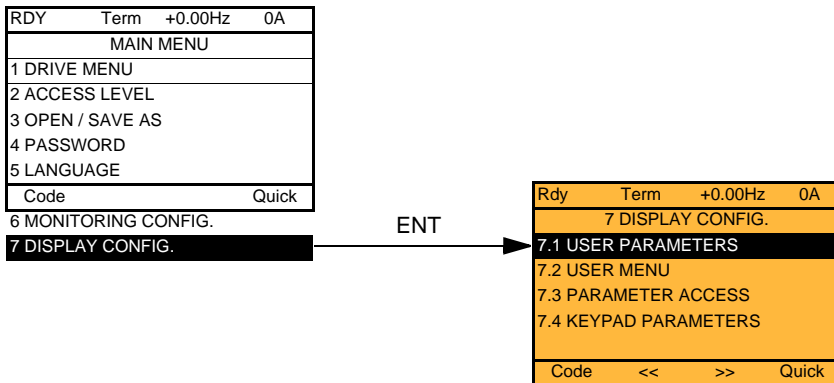

7.1: USER PARAMETERS: Customization of 1 to 15 parameters.

7.2 USER MENU: Creation of a customized menu.

7.3 PARAMETER ACCESS: Customization of the visibility and protection mechanisms of menus and parameters.

7.4 KEYPAD PARAMETERS: Adjustment of the contrast and stand-by mode of the graphic display terminal (parameters stored in the terminal rather than in the drive).

# [7 DISPLAY CONFIG.]

If [Return std name] = [Yes] the display reverts to standard but the custom settings remain stored.

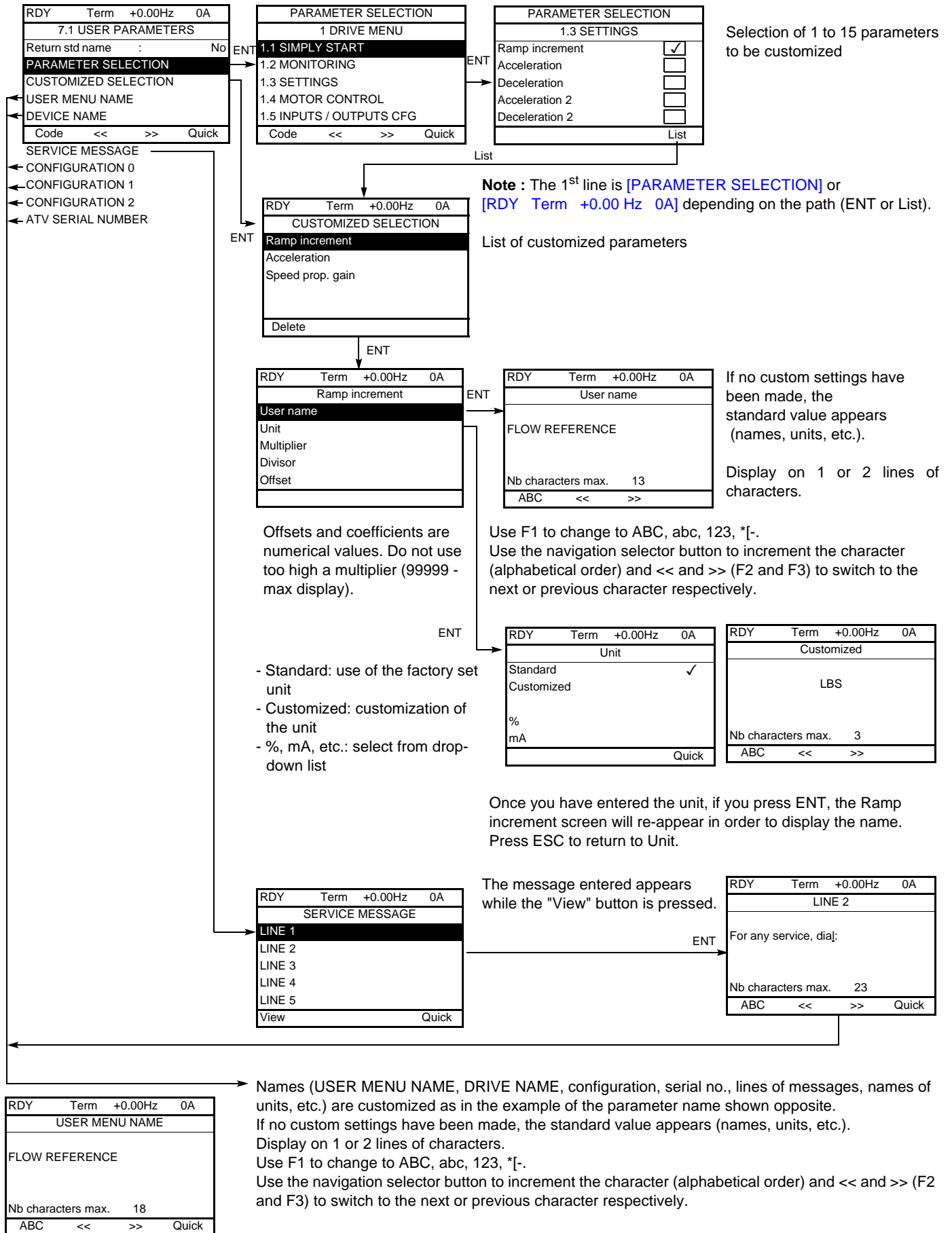

# [7 DISPLAY CONFIG.]

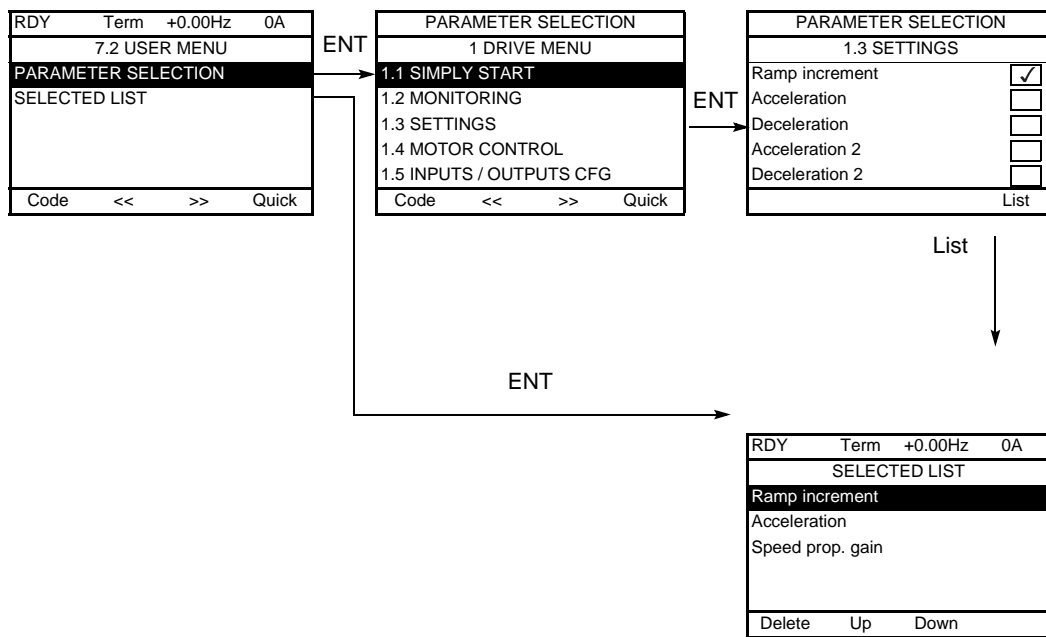

Selection of parameters included in the user menu

**Note:** The 1<sup>st</sup> line is [PARAMETER SELECTION] or [RDY Term +0.00 Hz 0A] depending on the path (ENT or List).

Parameter list making up the user menu.

Use the F2 and F3 keys to arrange the parameters in the list (example below using F3).

|                  |      |         |    |
|------------------|------|---------|----|
| RDY              | Term | +0.00Hz | 0A |
| SELECTED LIST    |      |         |    |
| Acceleration     |      |         |    |
| Ramp increment   |      |         |    |
| Speed prop. gain |      |         |    |
| Delete Up Down   |      |         |    |



# [7 DISPLAY CONFIG.]

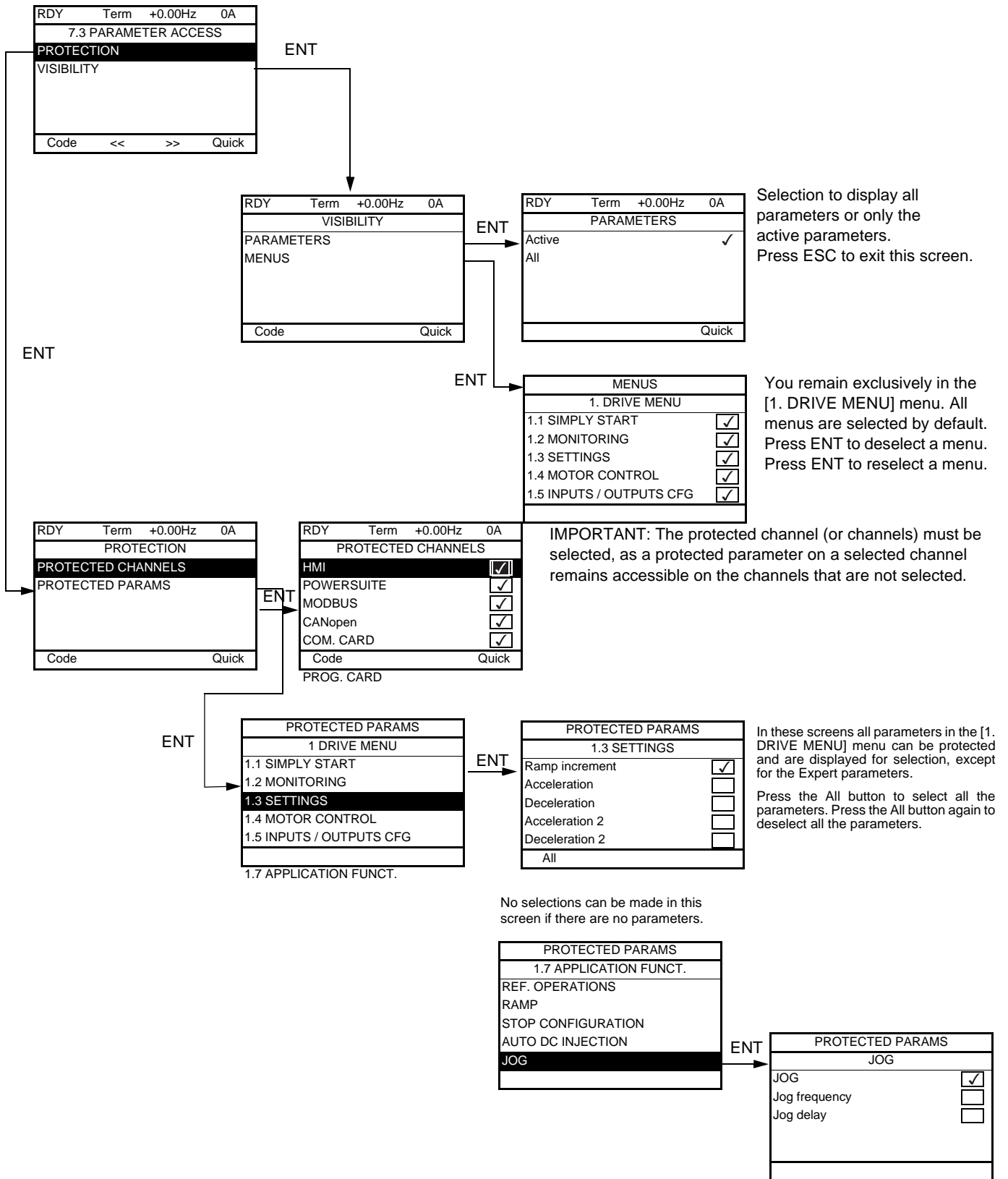

**Note:** The protected parameters are no longer accessible and are not, therefore, displayed for the selected channels.

## [7 DISPLAY CONFIG.]

|                       |      |         |       |
|-----------------------|------|---------|-------|
| RDY                   | Term | +0.00Hz | 0A    |
| 7.4 KEYPAD PARAMETERS |      |         |       |
| Contrast              |      |         |       |
| Keypad stand-by       |      |         |       |
| Code                  | <<   | >>      | Quick |

| Name/Description  | Adjustment range | Factory setting |
|---|------------------|-----------------|
| <input type="checkbox"/> <b>[Keypad contrast]</b><br>Adjustment of contrast on graphic display unit.  | 0 to 100 %       | 50 %            |
| <input type="checkbox"/> <b>[Keypad stand-by]</b><br>Configures and adjusts the stand-by mode of the graphic display unit. <ul style="list-style-type: none"><li><input type="checkbox"/> <b>[No]</b>: No stand-by mode.</li><li><input type="checkbox"/> <b>[1]</b> to <b>[10]</b>: Adjusts the time during which the terminal is to remain idle before stand-by mode is triggered, in minutes. After this idle time, the display backlight turns off and the contrast is reduced. The screen returns to normal operation when a key or the navigation button is pressed. It also returns to normal operation if the terminal exits the normal display mode, for example, if a fault occurs.</li></ul> | [5]              |                 |

# [MULTIPOINT SCREEN]

Communication is possible between a graphic display terminal and a number of drives connected on the same bus. The addresses of the drives must be configured in advance in the [\[1.9 COMMUNICATION\]](#) menu using the [\[Modbus Address\]](#) (Add) parameter, page [236](#).

When a number of drives are connected to the same display terminal, the terminal automatically displays the following screens:

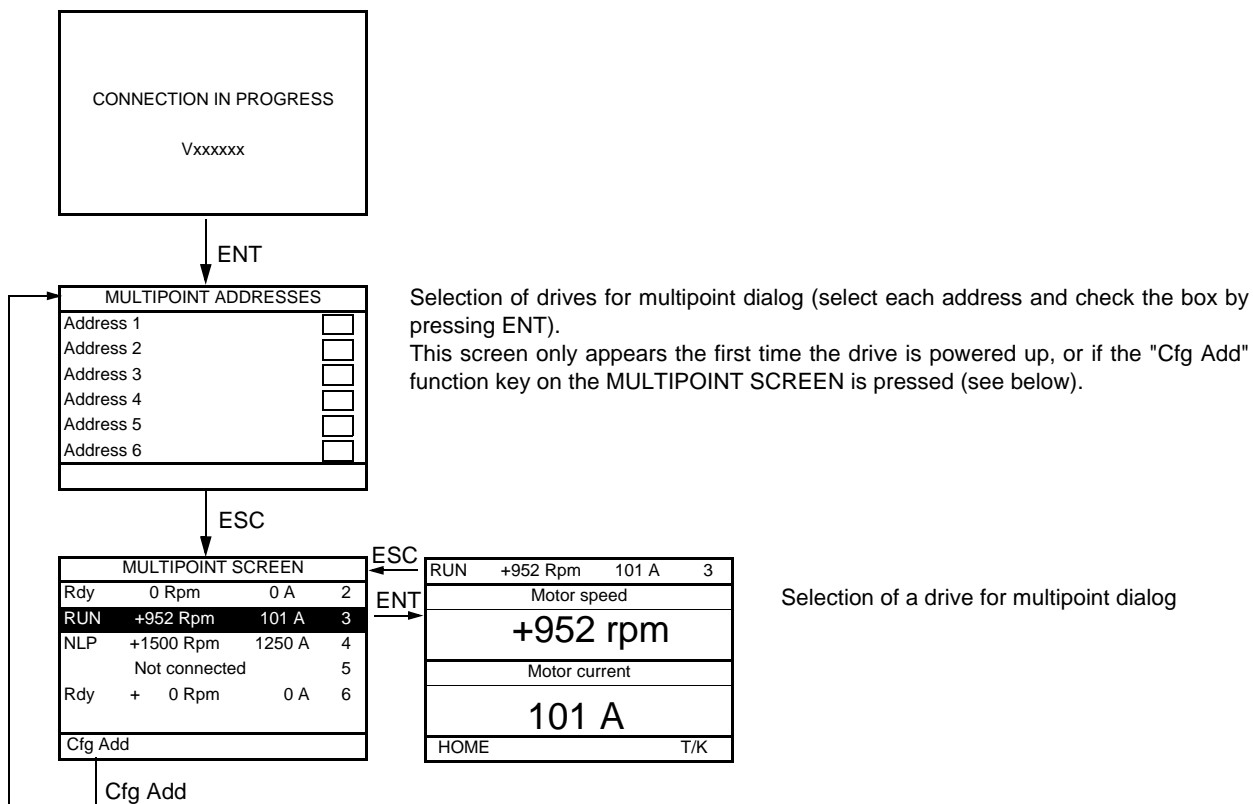

In multipoint mode, the command channel is not displayed. From left to right, the state, then the 2 selected parameters and finally the drive address appear.

**All menus can be accessed in multipoint mode. Only drive control via the graphic display terminal is not authorized, apart from the Stop key, which locks all the drives. If there is a fault on a drive, this drive is displayed.**

# Maintenance

---

## Servicing

The Altivar 71 does not require any preventive maintenance. It is nevertheless advisable to perform the following regularly:

- Check the condition and tightness of the connections.
- Ensure that the temperature around the unit remains at an acceptable level and that ventilation is effective (average service life of fans: 3 to 5 years, depending on the operating conditions).
- Remove any dust from the drive.

## Assistance with maintenance, fault display

If a problem arises during setup or operation, first check that the recommendations relating to the environment, mounting and connections have been observed.

The first fault detected is saved and displayed, and the drive locks.

The drive switching to fault mode can be indicated remotely via a logic output or a relay, which can be configured in the [\[1.5 INPUTS / OUTPUTS CFG\] \(I-O-\)](#) menu, see, for example, [\[R1 CONFIGURATION\] \(r1-\)](#) page [100](#).

## Menu [\[1.10 DIAGNOSTICS\]](#)

This menu can only be accessed with the graphic display terminal. It displays faults and their cause in plain text and can be used to carry out tests, see page [238](#).

## Clearing the fault

Disconnect the drive power supply in the event of a non-resettable fault.

Wait for the display to disappear completely.

Find the cause of the fault in order to correct it.

The drive is unlocked after a fault:

- By switching off the drive until the display disappears completely, then switching on again
- Automatically in the scenarios described for the [\[AUTOMATIC RESTART\] \(Atr-\)](#) function, page [214](#)
- By means of a logic input or control bit assigned to the [\[FAULT RESET\] \(rSt-\)](#) function, page [213](#)
- By pressing the STOP/RESET button on the graphic display terminal

## Menu [\[1.2 MONITORING\] \(SUP-\)](#):

This is used to prevent and find the causes of faults by displaying the drive state and its current values. It can be accessed with the integrated display terminal.

## Spares and repairs:

Consult Schneider Electric product support.

# Faults - Causes - Remedies

## Drive does not start, no fault displayed

- If the display does not light up, check the power supply to the drive.
- The assignment of the "Fast stop" or "Freewheel" functions will prevent the drive starting if the corresponding logic inputs are not powered up. The ATV71 then displays [Freewheel] (nSt) in freewheel stop and [Fast stop] (FSt) in fast stop. This is normal since these functions are active at zero so that the drive will be stopped safely if there is a wire break.
- Make sure that the run command input or inputs are activated in accordance with the selected control mode ([2/3 wire control] (tCC) and [2 wire type] (tCt) parameters, page 86).
- If an input is assigned to the limit switch function and this input is at zero, the drive can only be started up by sending a command for the opposite direction (see pages 151 and 189).
- If the reference channel or command channel is assigned to a communication bus, when the power supply is connected, the drive will display [Freewheel] (nSt) and remain in stop mode until the communication bus sends a command.

## Faults, which cannot be reset automatically

The cause of the fault must be removed before resetting by turning off and then back on.

AnF, brF, ECF, EnF, SOF, SPF and tnF faults can also be reset remotely by means of a logic input or control bit ([Fault reset] (rSF) parameter, page 213).

AnF, EnF, InFA, InFb, SOF, SPF, and tnF faults can be inhibited and cleared remotely by means of a logic input or control bit ([Fault inhibit assign.] (InH) parameter, page 224).

| Fault   | Name                  | Probable cause  | Remedy  |
|---------|-----------------------|---|---|
| A I 2 F | [AI2 input]           | <ul style="list-style-type: none"> <li>• Non-conforming signal on analog input AI2</li> </ul>   | <ul style="list-style-type: none"> <li>• Check the wiring of analog input AI2 and the value of the signal.</li> </ul>   |
| A n F   | [Load slipping]       | <ul style="list-style-type: none"> <li>• The encoder speed feedback does not match the reference</li> </ul>   | <ul style="list-style-type: none"> <li>• Check the motor, gain and stability parameters.</li> <li>• Add a braking resistor.</li> <li>• Check the size of the motor/drive/load.</li> <li>• Check the encoder's mechanical coupling and its wiring.</li> </ul>  |
| b D F   | [DBR overload]        | <ul style="list-style-type: none"> <li>• The braking resistor is under excessive stress</li> </ul>  | <ul style="list-style-type: none"> <li>• Check the size of the resistor and wait for it to cool down</li> <li>• Check the [DB Resistor Power] (brP) and [DB Resistor value] (brU) parameters, page 231.</li> </ul>  |
| b r F   | [Brake feedback]      | <ul style="list-style-type: none"> <li>• The brake feedback contact does not match the brake logic control</li> <li>• The brake does not stop the motor quickly enough (detected by measuring the speed on the "Pulse input" input).</li> </ul> | <ul style="list-style-type: none"> <li>• Check the feedback circuit and the brake logic control circuit</li> <li>• Check the mechanical state of the brake</li> <li>• Check the brake linings</li> </ul>  |
| b U F   | [DB unit sh. Circuit] | <ul style="list-style-type: none"> <li>• Short-circuit output from braking unit</li> <li>• Braking unit not connected</li> </ul>  | <ul style="list-style-type: none"> <li>• Check the wiring of the braking unit and the resistor.</li> <li>• Check the braking resistor</li> <li>• The monitoring of this fault must be disabled by the [Brake res. fault Mgt.] (bUb) parameter, page 231 if there is no resistor or braking unit connected to the drive, at and above 55 kW (75 HP) for ATV71●●●M3X and at and above 90 kW (120 HP) for ATV71●●●N4.</li> </ul> |
| C r F 1 | [Precharge]           | <ul style="list-style-type: none"> <li>• Charging relay control fault or charging resistor damaged</li> </ul>   | <ul style="list-style-type: none"> <li>• Turn the drive off and then back on again</li> <li>• Check the internal connections</li> <li>• Inspect/repair the drive</li> </ul>   |
| C r F 2 | [Thyr. soft charge]   | <ul style="list-style-type: none"> <li>• DC bus charging fault (thyristors)</li> </ul>  |   |
| E C F   | [Encoder coupling]    | <ul style="list-style-type: none"> <li>• Break in encoder's mechanical coupling</li> </ul>  | <ul style="list-style-type: none"> <li>• Check the encoder's mechanical coupling</li> </ul>   |
| E E F 1 | [Control Eeprom]      | <ul style="list-style-type: none"> <li>• Internal memory fault, control card</li> </ul>   | <ul style="list-style-type: none"> <li>• Check the environment (electromagnetic compatibility)</li> <li>• Turn off, reset, return to factory settings</li> <li>• Inspect/repair the drive</li> </ul>  |
| E E F 2 | [Power Eeprom]        | <ul style="list-style-type: none"> <li>• Internal memory fault, power card</li> </ul>   |   |
| E n F   | [Encoder]             | <ul style="list-style-type: none"> <li>• Encoder feedback fault</li> </ul>  | <ul style="list-style-type: none"> <li>• Check [Number of pulses] (PGI) and [Encoder type] (EnS) page 75.</li> <li>• Check that the encoder's mechanical and electrical operation, its power supply and connections are all correct</li> <li>• If necessary, reverse the direction of rotation of the motor ([Output Ph rotation] (PHr) parameter, page 68) or the encoder signals</li> </ul>                                 |
| F C F 1 | [Out. contact. stuck] | <ul style="list-style-type: none"> <li>• The output contactor remains closed although the opening conditions have been met</li> </ul>   | <ul style="list-style-type: none"> <li>• Check the contactor and its wiring</li> <li>• Check the feedback circuit</li> </ul>  |

# Faults - Causes - Remedies

## Faults, which cannot be reset automatically (continued)

| Fault          | Name                      | Probable cause  | Remedy   |
|----------------|---------------------------|---|--|
| <b>H d F</b>   | [IGBT desaturation]       | <ul style="list-style-type: none"> <li>Short-circuit or grounding at the drive output</li> </ul>  | <ul style="list-style-type: none"> <li>Check the cables connecting the drive to the motor, and the motor insulation.</li> <li>Perform the diagnostic tests via the <a href="#">[1.10 DIAGNOSTICS]</a> menu.</li> </ul>   |
| <b>IL F</b>    | [internal com. link]      | <ul style="list-style-type: none"> <li>Communication fault between option card and drive</li> </ul>   | <ul style="list-style-type: none"> <li>Check the environment (electromagnetic compatibility)</li> <li>Check the connections</li> <li>Check that no more than 2 option cards (max. permitted) have been installed on the drive</li> <li>Replace the option card</li> <li>Inspect/repair the drive</li> </ul>  |
| <b>I n F 1</b> | [Rating error]            | <ul style="list-style-type: none"> <li>The power card is different from the card stored</li> </ul>  | <ul style="list-style-type: none"> <li>Check the reference of the power card</li> </ul>  |
| <b>I n F 2</b> | [Incompatible PB]         | <ul style="list-style-type: none"> <li>The power card is incompatible with the control card</li> </ul>  | <ul style="list-style-type: none"> <li>Check the reference of the power card and its compatibility.</li> </ul>   |
| <b>I n F 3</b> | [Internal serial link]    | <ul style="list-style-type: none"> <li>Communication fault between the internal cards</li> </ul>  | <ul style="list-style-type: none"> <li>Check the internal connections</li> <li>Inspect/repair the drive</li> </ul>   |
| <b>I n F 4</b> | [Internal-mftg zone]      | <ul style="list-style-type: none"> <li>Internal data inconsistent</li> </ul>  | <ul style="list-style-type: none"> <li>Recalibrate the drive (performed by Schneider Electric Product Support).</li> </ul>   |
| <b>I n F 5</b> | [Internal - fault option] | <ul style="list-style-type: none"> <li>The option installed in the drive is not recognized</li> </ul>   | <ul style="list-style-type: none"> <li>Check the reference and compatibility of the option.</li> </ul>   |
| <b>I n F 7</b> | [Internal-hard init.]     | <ul style="list-style-type: none"> <li>Initialization of the drive is incomplete</li> </ul>   | <ul style="list-style-type: none"> <li>Turn off and reset.</li> </ul>  |
| <b>I n F 8</b> | [Internal-ctrl supply]    | <ul style="list-style-type: none"> <li>The control power supply is incorrect</li> </ul>   | <ul style="list-style-type: none"> <li>Check the control section power supply</li> </ul>   |
| <b>I n F 9</b> | [Internal- I measure]     | <ul style="list-style-type: none"> <li>The current measurements are incorrect</li> </ul>  | <ul style="list-style-type: none"> <li>Replace the current sensors or the power card.</li> <li>Inspect/repair the drive</li> </ul>   |
| <b>I n F A</b> | [Internal-mains circuit]  | <ul style="list-style-type: none"> <li>The input stage is not operating correctly</li> </ul>  | <ul style="list-style-type: none"> <li>Perform the diagnostic tests via the <a href="#">[1.10 DIAGNOSTICS]</a> menu.</li> <li>Inspect/repair the drive</li> </ul>  |
| <b>I n F b</b> | [Internal- th. sensor]    | <ul style="list-style-type: none"> <li>The drive temperature sensor is not operating correctly</li> <li>The braking unit's temperature sensor is not operating correctly.</li> </ul>  | <ul style="list-style-type: none"> <li>Replace the drive temperature sensor</li> <li>Inspect/repair the drive</li> <li>Replace the braking unit's temperature sensor</li> <li>Inspect/repair the braking unit</li> <li>The monitoring of this fault must be disabled by the <a href="#">[Brake res. fault Mgt.] (bUb)</a> parameter, page <a href="#">231</a> if there is no braking unit connected to the drive.</li> </ul> |
| <b>I n F C</b> | [Internal-time meas.]     | <ul style="list-style-type: none"> <li>Fault on the electronic time measurement component</li> </ul>  | <ul style="list-style-type: none"> <li>Inspect/repair the drive</li> </ul>   |
| <b>I n F E</b> | [internal- CPU ]          | <ul style="list-style-type: none"> <li>Internal microprocessor fault</li> </ul>   | <ul style="list-style-type: none"> <li>Turn off and reset. Inspect/repair the drive.</li> </ul>  |
| <b>O C F</b>   | [Overcurrent]             | <ul style="list-style-type: none"> <li>Parameters in the <a href="#">[SETTINGS] (SEt-)</a> and <a href="#">[1.4 MOTOR CONTROL] (drC-)</a> menus are not correct.</li> <li>Inertia or load too high</li> <li>Mechanical locking</li> </ul> | <ul style="list-style-type: none"> <li>Check the parameters.</li> <li>Check the size of the motor/drive/load.</li> <li>Check the state of the mechanism.</li> </ul>  |
| <b>P r F</b>   | [Power removal]           | <ul style="list-style-type: none"> <li>Fault with the drive's "Power removal" safety function</li> </ul>  | <ul style="list-style-type: none"> <li>Inspect/repair the drive</li> </ul>   |
| <b>S C F 1</b> | [Motor short circuit]     | <ul style="list-style-type: none"> <li>Short-circuit or grounding at the drive output</li> </ul>  | <ul style="list-style-type: none"> <li>Check the cables connecting the drive to the motor, and the motor insulation.</li> <li>Perform the diagnostic tests via the <a href="#">[1.10 DIAGNOSTICS]</a> menu.</li> </ul>   |
| <b>S C F 2</b> | [Impedant sh. circuit]    | <ul style="list-style-type: none"> <li>Significant earth leakage current at the drive output if several motors are connected in parallel</li> </ul>   | <ul style="list-style-type: none"> <li>Reduce the switching frequency.</li> <li>Connect chokes in series with the motor.</li> </ul>  |
| <b>S C F 3</b> | [Ground short circuit]    |   |  |
| <b>S O F</b>   | [Overspeed]               | <ul style="list-style-type: none"> <li>Instability or driving load too high</li> </ul>  | <ul style="list-style-type: none"> <li>Check the motor, gain and stability parameters.</li> <li>Add a braking resistor.</li> <li>Check the size of the motor/drive/load.</li> <li>Check the parameters settings for the <a href="#">[FREQUENCY METER] (FqF-)</a> function, page <a href="#">228</a>, if it is configured</li> </ul>  |

## Faults - Causes - Remedies

---

### Faults, which cannot be reset automatically (continued)

| Fault        | Name                | Probable cause  | Remedy   |
|--------------|---------------------|---|--|
| <b>S P F</b> | [Speed fdback loss] | <ul style="list-style-type: none"><li>Encoder feedback signal missing</li><li>Signal on "Pulse input" missing, if the input is used for speed measurement</li></ul> | <ul style="list-style-type: none"><li>Check the wiring between the encoder and the drive</li><li>Check the encoder</li><li>Check the wiring of the input cable and the detector used</li></ul>                                 |
| <b>E n F</b> | [Auto-tuning]       | <ul style="list-style-type: none"><li>Special motor or motor whose power is not suitable for the drive</li><li>Motor not connected to the drive</li></ul>           | <ul style="list-style-type: none"><li>Check that the motor/drive are compatible</li><li>Check that the motor is present during auto-tuning</li><li>If an output contactor is being used, close it during auto-tuning</li></ul> |

## Faults - Causes - Remedies

### Faults that can be reset with the automatic restart function, after the cause has disappeared

These faults can also be reset by turning on and off or by means of a logic input or control bit ([Fault reset] (rSF) parameter, page 213). APF, CnF, COF, EPF1, EPF2, FCF2, LFF2, LFF3, LFF4, ObF, OHF, OLF, OPF1, OPF2, OSF, OtF1, OtF2, OtFL, PHF, PtF1, PtF2, PtFL, SLF1, SLF2, SLF3, SrF, SSF and tJF faults can be inhibited and cleared remotely by means of a logic input or control bit ([Fault inhibit assign.] (InH)parameter, page 224).

| Fault                                     | Name  | Probable cause  | Remedy   |
|---|---|---|--|
| <b>APF</b>                                | [Application fault]   | <ul style="list-style-type: none"> <li>Controller Inside card fault</li> </ul>  | <ul style="list-style-type: none"> <li>Please refer to the card documentation</li> </ul>   |
| <b>bLF</b>                                | [Brake control]   | <ul style="list-style-type: none"> <li>Brake release current not reached</li> <li>Brake engage frequency threshold [Brake engage freq] (bEn) only regulated when brake logic control is assigned</li> </ul> | <ul style="list-style-type: none"> <li>Check the drive/motor connection</li> <li>Check the motor windings</li> <li>Check the [Brake release I FW] (Ibr) and [Brake release I Rev] (Ird) settings, page 157</li> <li>Apply the recommended settings for [Brake engage freq] (bEn).</li> </ul> |
| <b>CnF</b>                                | [Com. network]  | <ul style="list-style-type: none"> <li>Communication fault on communication card</li> </ul>   | <ul style="list-style-type: none"> <li>Check the environment (electromagnetic compatibility)</li> <li>Check the wiring.</li> <li>Check the time-out</li> <li>Replace the option card</li> <li>Inspect/repair the drive</li> </ul>  |
| <b>CDF</b>                                | [CANopen com.]  | <ul style="list-style-type: none"> <li>Interruption in communication on the CANopen bus</li> </ul>  | <ul style="list-style-type: none"> <li>Check the communication bus.</li> <li>Check the time-out</li> <li>Refer to the CANopen User's Manual</li> </ul>   |
| <b>EPF1</b>                               | [External flt-LI/Bit]                                       | <ul style="list-style-type: none"> <li>Fault triggered by an external device, depending on user</li> </ul>  | <ul style="list-style-type: none"> <li>Check the device which caused the fault, and reset</li> </ul>   |
| <b>EPF2</b>                               | [External fault com.]                                       | <ul style="list-style-type: none"> <li>Fault triggered by a communication network</li> </ul>  | <ul style="list-style-type: none"> <li>Check for the cause of the fault and reset</li> </ul>   |
| <b>FCF2</b>                               | [Out. contact. open.]                                       | <ul style="list-style-type: none"> <li>The output contactor remains open although the closing conditions have been met</li> </ul>   | <ul style="list-style-type: none"> <li>Check the contactor and its wiring</li> <li>Check the feedback circuit</li> </ul>   |
| <b>LCF</b>                                | [input contactor]   | <ul style="list-style-type: none"> <li>The drive is not turned on even though [Mains V. time out] (LCt) has elapsed.</li> </ul>   | <ul style="list-style-type: none"> <li>Check the contactor and its wiring</li> <li>Check the time-out</li> <li>Check the line/contactor/drive connection</li> </ul>  |
| <b>LFF2</b><br><b>LFF3</b><br><b>LFF4</b> | [AI2 4-20mA loss]<br>[AI3 4-20mA loss]<br>[AI4 4-20mA loss] | <ul style="list-style-type: none"> <li>Loss of the 4-20 mA reference on analog input AI2, AI3 or AI4</li> </ul>   | <ul style="list-style-type: none"> <li>Check the connection on the analog inputs.</li> </ul>   |
| <b>ObF</b>                                | [Overbraking]   | <ul style="list-style-type: none"> <li>Braking too sudden or driving load</li> </ul>  | <ul style="list-style-type: none"> <li>Increase the deceleration time</li> <li>Install a braking resistor if necessary</li> <li>Activate the [Dec ramp adapt.] (brA) function, page 136, if it is compatible with the application</li> </ul>   |
| <b>OHF</b>                                | [Drive overheat]  | <ul style="list-style-type: none"> <li>Drive temperature too high</li> </ul>  | <ul style="list-style-type: none"> <li>Check the motor load, the drive ventilation and the ambient temperature. Wait for the drive to cool down before restarting.</li> </ul>  |
| <b>OLF</b>                                | [Motor overload]  | <ul style="list-style-type: none"> <li>Triggered by excessive motor current</li> </ul>  | <ul style="list-style-type: none"> <li>Check the setting of the motor thermal protection, check the motor load. Wait for the drive to cool down before restarting.</li> </ul>  |
| <b>OPF1</b>                               | [1 output phase loss]                                       | <ul style="list-style-type: none"> <li>Loss of one phase at drive output</li> </ul>   | <ul style="list-style-type: none"> <li>Check the connections from the drive to the motor</li> </ul>  |



# Faults - Causes - Remedies

## Faults that can be reset with the automatic restart function, after the cause has disappeared (continued)

| Fault       | Name                  | Probable cause  | Remedy   |
|-------------|-----------------------|---|--|
| <b>OPF2</b> | [3 motor phase loss]  | <ul style="list-style-type: none"> <li>Motor not connected or motor power too low</li> <li>Output contactor open</li> <li>Instantaneous instability in the motor current</li> </ul> | <ul style="list-style-type: none"> <li>Check the connections from the drive to the motor</li> <li>If an output contactor is being used, parameterize [Output Phase Loss] (OPL) = [Output cut] (OAC), page 217.</li> <li>Test on a low power motor or without a motor: In factory settings mode, motor phase loss detection is active [Output Phase Loss] (OPL) = [Yes] (YES). To check the drive in a test or maintenance environment, without having to use a motor with the same rating as the drive (in particular for high power drives), deactivate motor phase loss detection [Output Phase Loss] (OPL) = [No] (nO)</li> <li>Check and optimize the following parameters: [IR compensation] (UFR), page 72, [Rated motor volt.] (UnS) and [Rated mot. current] (nCr) page 67 and perform [Auto-tuning] (tUn) page 68.</li> </ul> |
| <b>OSF</b>  | [Mains overvoltage]   | <ul style="list-style-type: none"> <li>Line voltage too high</li> <li>Disturbed mains supply</li> </ul>   | <ul style="list-style-type: none"> <li>Check the line voltage</li> </ul>   |
| <b>OTF1</b> | [PTC1 overheat]       | <ul style="list-style-type: none"> <li>Overheating of the PTC1 probes detected</li> </ul>   | <ul style="list-style-type: none"> <li>Check the motor load and motor size.</li> <li>Check the motor ventilation.</li> <li>Wait for the motor to cool before restarting</li> <li>Check the type and state of the PTC probes</li> </ul>   |
| <b>OTF2</b> | [PTC2 overheat]       | <ul style="list-style-type: none"> <li>Overheating of the PTC2 probes detected</li> </ul>   |  |
| <b>OTFL</b> | [LI6=PTC overheat]    | <ul style="list-style-type: none"> <li>Overheating of PTC probes detected on input LI6</li> </ul>   |  |
| <b>PTF1</b> | [PTC1 probe]          | <ul style="list-style-type: none"> <li>PTC1 probes open or short-circuited</li> </ul>   |  |
| <b>PTF2</b> | [PTC2 probe]          | <ul style="list-style-type: none"> <li>PTC2 probes open or short-circuited</li> </ul>   | <ul style="list-style-type: none"> <li>Check the PTC probes and the wiring between them and the motor/drive</li> </ul>   |
| <b>PTFL</b> | [LI6=PTC probe]       | <ul style="list-style-type: none"> <li>PTC probes on input LI6 open or short-circuited</li> </ul>   |  |
| <b>SCF4</b> | [IGBT short circuit]  | <ul style="list-style-type: none"> <li>Power component fault</li> </ul>   |  |
| <b>SCF5</b> | [Motor short circuit] | <ul style="list-style-type: none"> <li>Short-circuit at drive output</li> </ul>   | <ul style="list-style-type: none"> <li>Perform a test via the [1.10 DIAGNOSTICS] menu.</li> <li>Inspect/repair the drive</li> </ul>  |
| <b>SLF1</b> | [Modbus com.]         | <ul style="list-style-type: none"> <li>Interruption in communication on the Modbus bus</li> </ul>   | <ul style="list-style-type: none"> <li>Check the cables connecting the drive to the motor, and the motor's insulation</li> <li>Perform tests via the [1.10 DIAGNOSTICS] menu.</li> <li>Inspect/repair the drive</li> </ul>   |
| <b>SLF2</b> | [PowerSuite com.]     | <ul style="list-style-type: none"> <li>Interruption in communication on the Modbus bus</li> </ul>   | <ul style="list-style-type: none"> <li>Check the communication bus.</li> <li>Check the time-out</li> <li>Refer to the Modbus User's Manual</li> </ul>  |
| <b>SLF3</b> | [HMI com.]            | <ul style="list-style-type: none"> <li>Fault communicating with PowerSuite</li> </ul>   | <ul style="list-style-type: none"> <li>Check the PowerSuite connecting cable.</li> <li>Check the time-out</li> </ul>   |
| <b>SrF</b>  | [TORQUE TIME OUT FLT] | <ul style="list-style-type: none"> <li>Fault communicating with the graphic display terminal</li> </ul>   | <ul style="list-style-type: none"> <li>Check the terminal connection</li> <li>Check the time-out</li> </ul>  |
| <b>SrF</b>  | [TORQUE TIME OUT FLT] | <ul style="list-style-type: none"> <li>The time-out of the torque control function is attained</li> </ul>   | <ul style="list-style-type: none"> <li>Check the function's settings</li> <li>Check the state of the mechanism</li> </ul>  |
| <b>SSF</b>  | [Torque/current lim]  | <ul style="list-style-type: none"> <li>Switch to torque limitation</li> </ul>   | <ul style="list-style-type: none"> <li>Check if there are any mechanical problems</li> <li>Check the parameters of [TORQUE LIMITATION] (tLA-) page 182 and the parameters of the [TORQUE OR I LIM. DETECT.] (tId-) fault, page 226).</li> </ul>  |
| <b>tJF</b>  | [IGBT overheat]       | <ul style="list-style-type: none"> <li>Drive overheated</li> </ul>  | <ul style="list-style-type: none"> <li>Check the size of the load/motor/drive.</li> <li>Reduce the switching frequency.</li> <li>Wait for the motor to cool before restarting</li> </ul>   |

# Faults - Causes - Remedies

## Faults that can be reset as soon as their causes disappear

The USF fault can be inhibited and cleared remotely by means of a logic input or control bit ([[Fault inhibit assign.](#)] (InH) parameter, page [224](#)).

| Fault      | Name                                   | Probable cause  | Remedy  |
|------------|--|---|---|
| <b>CFF</b> | [ <a href="#">Incorrect config.</a> ]  | <ul style="list-style-type: none"> <li>Option card changed or removed</li> <li>Control card replaced by a control card configured on a drive with a different rating</li> <li>The current configuration is inconsistent</li> </ul>  | <ul style="list-style-type: none"> <li>Check that there are no card errors.</li> <li>In the event of the option card being changed/removed deliberately, see the remarks below</li> <li>Check that there are no card errors.</li> <li>In the event of the control card being changed deliberately, see the remarks below</li> <li>Return to factory settings or retrieve the backup configuration, if it is valid (see page <a href="#">243</a>)</li> </ul> |
| <b>CFI</b> | [ <a href="#">Invalid config.</a> ]    | <ul style="list-style-type: none"> <li>Invalid configuration<br/>The configuration loaded in the drive via the bus or communication network is inconsistent.</li> </ul>   | <ul style="list-style-type: none"> <li>Check the configuration loaded previously.</li> <li>Load a compatible configuration</li> </ul>   |
| <b>dLF</b> | [ <a href="#">Dynamic load fault</a> ] | <ul style="list-style-type: none"> <li>Abnormal load variation</li> </ul>   | <ul style="list-style-type: none"> <li>Check that the load is not blocked by an obstacle</li> <li>Removal of a run command causes a reset</li> </ul>  |
| <b>HCF</b> | [ <a href="#">Cards pairing</a> ]      | <ul style="list-style-type: none"> <li>The [<a href="#">CARDS PAIRING</a>] (PPI-) function, page <a href="#">232</a>, has been configured and a drive card has been changed</li> </ul>  | <ul style="list-style-type: none"> <li>In the event of a card error, reinsert the original card</li> <li>Confirm the configuration by entering the [<a href="#">Pairing password</a>] (PPI) if the card was changed deliberately</li> </ul>   |
| <b>PHF</b> | [ <a href="#">Input phase loss</a> ]   | <ul style="list-style-type: none"> <li>Drive incorrectly supplied or a fuse blown</li> <li>Failure of one phase</li> <li>3-phase ATV71 used on a single-phase line supply</li> <li>Unbalanced load</li> </ul> <p>This protection only operates with the drive on load</p> | <ul style="list-style-type: none"> <li>Check the power connection and the fuses.</li> <li>Use a 3-phase line supply.</li> <li>Disable the fault by [<a href="#">Input phase loss</a>] (IPL) = [No] (nO). (page <a href="#">218</a>)</li> </ul>  |
| <b>USF</b> | [ <a href="#">Undervoltage</a> ]       | <ul style="list-style-type: none"> <li>Line supply too low</li> <li>Transient voltage dip</li> </ul>  | <ul style="list-style-type: none"> <li>Check the voltage and the parameters of [<a href="#">UNDERVOLTAGE MGT</a>] (USB-), page <a href="#">221</a></li> </ul>   |

### Option card changed or removed

When an option card is removed or replaced by another, the drive locks in [[Incorrect config.](#)] (CFF) fault mode on power-up. If the card has been deliberately changed or removed, the fault can be cleared by pressing the ENT key twice, which **causes the factory settings to be restored** (see page [243](#)) for the parameter groups affected by the card. These are as follows:

#### Card replaced by a card of the same type

- I/O cards: [[Drive menu](#)] (drM)
- Encoder cards: [[Drive menu](#)] (drM)
- Communication cards: only the parameters that are specific to communication cards
- Controller Inside cards: [[Prog. card menu](#)] (PLC)

#### Card removed (or replaced by a different type of card)

- I/O card: [[Drive menu](#)] (drM)
- Encoder card: [[Drive menu](#)] (drM)
- Communication card: [[Drive menu](#)] (drM) and parameters specific to communication cards
- Controller Inside card: [[Drive menu](#)] (drM) and [[Prog. card menu](#)] (PLC)

### Control card changed

When a control card is replaced by a control card configured on a drive with a different rating, the drive locks in [[Incorrect config.](#)] (CFF) fault mode on power-up. If the card has been deliberately changed, the fault can be cleared by pressing the ENT key twice, which **causes all the factory settings to be restored**.

## User settings tables

### Menu [1.1 SIMPLY START] (SIM-)

| Code         | Name                         | Factory setting           | Customer setting |
|--------------|------------------------------|---------------------------|------------------|
| <b>E C C</b> | <b>[2/3 wire control]</b>    | [2 wire] (2C)             |                  |
| <b>C F G</b> | <b>[Macro configuration]</b> | [Start/Stop] (StS)        |                  |
| <b>b F r</b> | <b>[Standard mot. freq]</b>  | [50 Hz] (50)              |                  |
| <b>n P r</b> | <b>[Rated motor power]</b>   | According to drive rating |                  |
| <b>U n S</b> | <b>[Rated motor volt.]</b>   | According to drive rating |                  |
| <b>n C r</b> | <b>[Rated mot. current]</b>  | According to drive rating |                  |
| <b>F r S</b> | <b>[Rated motor freq.]</b>   | 50 Hz                     |                  |
| <b>n S P</b> | <b>[Rated motor speed]</b>   | According to drive rating |                  |
| <b>t F r</b> | <b>[Max frequency]</b>       | 60 Hz                     |                  |
| <b>P H r</b> | <b>[Output Ph rotation]</b>  | ABC                       |                  |
| <b>I t H</b> | <b>[Mot. therm. current]</b> | According to drive rating |                  |
| <b>A C C</b> | <b>[Acceleration]</b>        | 3.0 s                     |                  |
| <b>d E C</b> | <b>[Deceleration]</b>        | 3.0 s                     |                  |
| <b>L S P</b> | <b>[Low speed]</b>           | 0                         |                  |
| <b>H S P</b> | <b>[High speed]</b>          | 50 Hz                     |                  |

### Functions assigned to I/O

| Inputs<br>Outputs | Functions assigned |
|-------------------|--------------------|
| LI1               |                    |
| LI2               |                    |
| LI3               |                    |
| LI4               |                    |
| LI5               |                    |
| LI6               |                    |
| LI7               |                    |
| LI8               |                    |
| LI9               |                    |
| LI10              |                    |
| LI11              |                    |
| LI12              |                    |
| LI13              |                    |
| LI14              |                    |

| Inputs<br>Outputs | Functions assigned |
|-------------------|--------------------|
| LO1               |                    |
| LO2               |                    |
| LO3               |                    |
| LO4               |                    |
| AI1               |                    |
| AI2               |                    |
| AI3               |                    |
| AI4               |                    |
| R1                |                    |
| R2                |                    |
| R3                |                    |
| R4                |                    |
| RP                |                    |
| Encoder           |                    |



# Index of functions

|   |                     |
|---|---------------------|
| [2 wire] (2C)   | <a href="#">39</a>  |
| [2nd CURRENT LIMIT.]  | <a href="#">184</a> |
| [3 wire] (3C)   | <a href="#">39</a>  |
| +/- speed   | <a href="#">145</a> |
| +/- speed around a reference  | <a href="#">147</a> |
| [AUTO DC INJECTION]   | <a href="#">139</a> |
| [AUTOMATIC RESTART]   | <a href="#">214</a> |
| [Auto tuning]   | <a href="#">41</a>  |
| [AUTO TUNING BY LI]   | <a href="#">199</a> |
| Brake logic control   | <a href="#">153</a> |
| [CATCH ON THE FLY]  | <a href="#">215</a> |
| Command and reference channels  | <a href="#">114</a> |
| Deferred stop on thermal alarm  | <a href="#">219</a> |
| Direct power supply via DC bus  | <a href="#">209</a> |
| [DRIVE OVERHEAT]  | <a href="#">218</a> |
| [ENA SYSTEM]  | <a href="#">77</a>  |
| [ENCODER CONFIGURATION]   | <a href="#">98</a>  |
| [EVACUATION]  | <a href="#">207</a> |
| [1.12 FACTORY SETTINGS] (FCS-)  | <a href="#">241</a> |
| [FAULT RESET]   | <a href="#">213</a> |
| [FLUXING BY LI]   | <a href="#">150</a> |
| Half floor  | <a href="#">208</a> |
| High-speed hoisting   | <a href="#">164</a> |
| [JOG]   | <a href="#">141</a> |
| Limit switch management   | <a href="#">151</a> |
| Line contactor command  | <a href="#">185</a> |
| Load measurement  | <a href="#">162</a> |
| [Load sharing]  | <a href="#">82</a>  |
| Load variation detection  | <a href="#">229</a> |
| Motor or configuration switching [MULTIMOTORS/CONFIG.]                        | <a href="#">197</a> |
| Motor thermal protection  | <a href="#">216</a> |
| [Noise reduction]   | <a href="#">80</a>  |
| Output contactor command  | <a href="#">187</a> |
| Parameter set switching [PARAM. SET SWITCHING]                                | <a href="#">194</a> |
| [4. PASSWORD] (COd-)  | <a href="#">248</a> |
| PID regulator   | <a href="#">169</a> |
| Positioning by sensors or limit switches                                      | <a href="#">189</a> |
| Preset speeds   | <a href="#">142</a> |
| PTC probes  | <a href="#">211</a> |
| [RAMP]  | <a href="#">134</a> |
| [REFERENCE SWITCH.]   | <a href="#">132</a> |
| Rope slack  | <a href="#">167</a> |
| [RP CONFIGURATION]  | <a href="#">96</a>  |
| Save reference  | <a href="#">149</a> |
| [STOP CONFIGURATION]  | <a href="#">137</a> |
| Stop at distance calculated after deceleration limit switch                   | <a href="#">191</a> |
| Summing input/Subtracting input/Multiplier                                    | <a href="#">131</a> |
| Synchronous motor   | <a href="#">74</a>  |
| Torque limitation   | <a href="#">181</a> |
| Torque regulation   | <a href="#">178</a> |
| Traverse control  | <a href="#">200</a> |
| Use of the "Pulse input" input to measure the speed of rotation of the motor. | <a href="#">227</a> |

# Index of parameter codes

| Code    | Page                            |                               |                             |                                  |   |                            |  |                                     |                                  |                                      |                           |
|---------|---------------------------------|-------------------------------|-----------------------------|----------------------------------|---|----------------------------|--|-------------------------------------|----------------------------------|--------------------------------------|---------------------------|
|         | [1.1 SIMPLY START]<br>(S I P -) | [1.2 MONITORING]<br>(S U P -) | [1.3 SETTINGS]<br>(S E T -) | [1.4 MOTOR CONTROL]<br>(D R C -) | [1.5 INPUTS / OUTPUTS CFG]<br>(I - O -) | [1.6 COMMAND]<br>(C L L -) | [1.7 APPLICATION FUNCT.]<br>(F U N -)          | [1.8 FAULT MANAGEMENT]<br>(F L T -) | [1.9 COMMUNICATION]<br>(C O M -) | [1.12 FACTORY SETTINGS]<br>(F L S -) | [4 PASSWORD]<br>(C O D -) |
| A 1 C - |                                 |                               |                             |                                  | <a href="#">112</a>                     |                            |  |                                     |                                  |                                      |                           |
| A 2 C - |                                 |                               |                             |                                  | <a href="#">112</a>                     |                            |  |                                     |                                  |                                      |                           |
| A 3 C - |                                 |                               |                             |                                  | <a href="#">112</a>                     |                            |  |                                     |                                  |                                      |                           |
| A C 2   |                                 |                               | <a href="#">53</a>          |                                  |   |                            | <a href="#">136 148</a><br><a href="#">175</a> |                                     |                                  |                                      |                           |
| A C C   | <a href="#">42</a>              |                               | <a href="#">53</a>          |                                  |   |                            | <a href="#">134</a>                            |                                     |                                  |                                      |                           |
| A d C   |                                 |                               |                             |                                  |   |                            | <a href="#">139</a>                            |                                     |                                  |                                      |                           |
| A d C O |                                 |                               |                             |                                  |   |                            |  | <a href="#">236</a>                 |                                  |                                      |                           |
| A d d   |                                 |                               |                             |                                  |   |                            |  | <a href="#">236</a>                 |                                  |                                      |                           |
| A 1 1 A |                                 | <a href="#">50</a>            |                             |                                  | <a href="#">91</a>                      |                            |  |                                     |                                  |                                      |                           |
| A 1 1 E |                                 |                               |                             |                                  | <a href="#">91</a>                      |                            |  |                                     |                                  |                                      |                           |
| A 1 1 F |                                 |                               |                             |                                  | <a href="#">91</a>                      |                            |  |                                     |                                  |                                      |                           |
| A 1 1 S |                                 |                               |                             |                                  | <a href="#">91</a>                      |                            |  |                                     |                                  |                                      |                           |
| A 1 1 t |                                 |                               |                             |                                  | <a href="#">91</a>                      |                            |  |                                     |                                  |                                      |                           |
| A 1 2 A |                                 | <a href="#">50</a>            |                             |                                  | <a href="#">92</a>                      |                            |  |                                     |                                  |                                      |                           |
| A 1 2 E |                                 |                               |                             |                                  | <a href="#">92</a>                      |                            |  |                                     |                                  |                                      |                           |
| A 1 2 F |                                 |                               |                             |                                  | <a href="#">92</a>                      |                            |  |                                     |                                  |                                      |                           |
| A 1 2 L |                                 |                               |                             |                                  | <a href="#">92</a>                      |                            |  |                                     |                                  |                                      |                           |
| A 1 2 S |                                 |                               |                             |                                  | <a href="#">92</a>                      |                            |  |                                     |                                  |                                      |                           |
| A 1 2 t |                                 |                               |                             |                                  | <a href="#">92</a>                      |                            |  |                                     |                                  |                                      |                           |
| A 1 3 A |                                 | <a href="#">50</a>            |                             |                                  | <a href="#">93</a>                      |                            |  |                                     |                                  |                                      |                           |
| A 1 3 E |                                 |                               |                             |                                  | <a href="#">93</a>                      |                            |  |                                     |                                  |                                      |                           |
| A 1 3 F |                                 |                               |                             |                                  | <a href="#">93</a>                      |                            |  |                                     |                                  |                                      |                           |
| A 1 3 L |                                 |                               |                             |                                  | <a href="#">93</a>                      |                            |  |                                     |                                  |                                      |                           |
| A 1 3 S |                                 |                               |                             |                                  | <a href="#">93</a>                      |                            |  |                                     |                                  |                                      |                           |
| A 1 3 t |                                 |                               |                             |                                  | <a href="#">93</a>                      |                            |  |                                     |                                  |                                      |                           |
| A 1 4 A |                                 | <a href="#">50</a>            |                             |                                  | <a href="#">94</a>                      |                            |  |                                     |                                  |                                      |                           |
| A 1 4 E |                                 |                               |                             |                                  | <a href="#">94</a>                      |                            |  |                                     |                                  |                                      |                           |
| A 1 4 F |                                 |                               |                             |                                  | <a href="#">94</a>                      |                            |  |                                     |                                  |                                      |                           |
| A 1 4 L |                                 |                               |                             |                                  | <a href="#">94</a>                      |                            |  |                                     |                                  |                                      |                           |
| A 1 4 S |                                 |                               |                             |                                  | <a href="#">94</a>                      |                            |  |                                     |                                  |                                      |                           |
| A 1 4 t |                                 |                               |                             |                                  | <a href="#">94</a>                      |                            |  |                                     |                                  |                                      |                           |
| A 1 C 1 |                                 |                               |                             |                                  | <a href="#">95</a>                      |                            | <a href="#">173</a>                            |                                     |                                  |                                      |                           |
| A L G r |                                 | <a href="#">49, 51</a>        |                             |                                  |   |                            |  |                                     |                                  |                                      |                           |
| A N O A |                                 |                               |                             |                                  |   |                            |  | <a href="#">236</a>                 |                                  |                                      |                           |
| A N O C |                                 |                               |                             |                                  |   |                            |  | <a href="#">236</a>                 |                                  |                                      |                           |
| A D 1   |                                 |                               |                             |                                  | <a href="#">108</a>                     |                            |  |                                     |                                  |                                      |                           |

# Index of parameter codes

| Code | Page                            |                               |                             |                                  |   |                            |                                       |                                     |                                  |                                      |                           |
|------|---------------------------------|-------------------------------|-----------------------------|----------------------------------|---|----------------------------|---------------------------------------|-------------------------------------|----------------------------------|--------------------------------------|---------------------------|
|      | [1.1 SIMPLY START]<br>(S I P -) | [1.2 MONITORING]<br>(S U P -) | [1.3 SETTINGS]<br>(S E T -) | [1.4 MOTOR CONTROL]<br>(D R C -) | [1.5 INPUTS / OUTPUTS CFG]<br>(I - O -) | [1.6 COMMAND]<br>(C L L -) | [1.7 APPLICATION FUNCT.]<br>(F U N -) | [1.8 FAULT MANAGEMENT]<br>(F L T -) | [1.9 COMMUNICATION]<br>(C O M -) | [1.12 FACTORY SETTINGS]<br>(F L S -) | [4 PASSWORD]<br>(C O D -) |
| ADIF |                                 |                               |                             |                                  | 109                                     |                            |                                       |                                     |                                  |                                      |                           |
| ADIE |                                 |                               |                             |                                  | 108                                     |                            |                                       |                                     |                                  |                                      |                           |
| AD2  |                                 |                               |                             |                                  | 110                                     |                            |                                       |                                     |                                  |                                      |                           |
| AD2F |                                 |                               |                             |                                  | 110                                     |                            |                                       |                                     |                                  |                                      |                           |
| AD2E |                                 |                               |                             |                                  | 110                                     |                            |                                       |                                     |                                  |                                      |                           |
| AD3  |                                 |                               |                             |                                  | 111                                     |                            |                                       |                                     |                                  |                                      |                           |
| AD3F |                                 |                               |                             |                                  | 111                                     |                            |                                       |                                     |                                  |                                      |                           |
| AD3E |                                 |                               |                             |                                  | 111                                     |                            |                                       |                                     |                                  |                                      |                           |
| ADH1 |                                 |                               |                             |                                  | 108                                     |                            |                                       |                                     |                                  |                                      |                           |
| ADH2 |                                 |                               |                             |                                  | 110                                     |                            |                                       |                                     |                                  |                                      |                           |
| ADH3 |                                 |                               |                             |                                  | 111                                     |                            |                                       |                                     |                                  |                                      |                           |
| ADL1 |                                 |                               |                             |                                  | 108                                     |                            |                                       |                                     |                                  |                                      |                           |
| ADL2 |                                 |                               |                             |                                  | 110                                     |                            |                                       |                                     |                                  |                                      |                           |
| ADL3 |                                 |                               |                             |                                  | 111                                     |                            |                                       |                                     |                                  |                                      |                           |
| APH  |                                 | 49, 51                        |                             |                                  |   |                            |                                       |                                     |                                  |                                      |                           |
| ASH1 |                                 |                               |                             |                                  | 109                                     |                            |                                       |                                     |                                  |                                      |                           |
| ASH2 |                                 |                               |                             |                                  | 110                                     |                            |                                       |                                     |                                  |                                      |                           |
| ASH3 |                                 |                               |                             |                                  | 111                                     |                            |                                       |                                     |                                  |                                      |                           |
| ASL1 |                                 |                               |                             |                                  | 109                                     |                            |                                       |                                     |                                  |                                      |                           |
| ASL2 |                                 |                               |                             |                                  | 110                                     |                            |                                       |                                     |                                  |                                      |                           |
| ASL3 |                                 |                               |                             |                                  | 111                                     |                            |                                       |                                     |                                  |                                      |                           |
| AEr  |                                 |                               |                             |                                  |   |                            | 214                                   |                                     |                                  |                                      |                           |
| AU1- |                                 |                               |                             |                                  | 95                                      |                            |                                       |                                     |                                  |                                      |                           |
| AUS  |                                 | 49, 51                        |                             |                                  |   |                            |                                       |                                     |                                  |                                      |                           |
| AUE  |                                 |                               |                             | 68                               |   |                            |                                       |                                     |                                  |                                      |                           |
| bbA  |                                 |                               |                             | 82                               |   |                            |                                       |                                     |                                  |                                      |                           |
| bCI  |                                 |                               |                             |                                  |   | 157                        |                                       |                                     |                                  |                                      |                           |
| bCLO |                                 |                               |                             |                                  |   |                            |                                       | 236                                 |                                  |                                      |                           |
| bECd |                                 |                               |                             |                                  |   | 158                        |                                       |                                     |                                  |                                      |                           |
| bEd  |                                 |                               |                             |                                  |   | 159                        |                                       |                                     |                                  |                                      |                           |
| bEn  |                                 |                               | 63                          |                                  |   | 158                        |                                       |                                     |                                  |                                      |                           |
| bEE  |                                 |                               | 64                          |                                  |   | 158                        |                                       |                                     |                                  |                                      |                           |
| bFr  | 40                              |                               | 67                          |                                  |   |                            |                                       |                                     |                                  |                                      |                           |
| bIP  |                                 |                               |                             |                                  |   | 157                        |                                       |                                     |                                  |                                      |                           |
| bIr  |                                 |                               | 63                          |                                  |   | 158                        |                                       |                                     |                                  |                                      |                           |
| bLC  |                                 |                               |                             |                                  |   | 157                        |                                       |                                     |                                  |                                      |                           |

# Index of parameter codes

| Code           | Page                            |                               |                             |                                  |  |                            |                                       |                                     |                                  |                                      |                           |
|----------------|---------------------------------|-------------------------------|-----------------------------|----------------------------------|--|----------------------------|---------------------------------------|-------------------------------------|----------------------------------|--------------------------------------|---------------------------|
|                | [1.1 SIMPLY START]<br>(S I P -) | [1.2 MONITORING]<br>(S U P -) | [1.3 SETTINGS]<br>(S E T -) | [1.4 MOTOR CONTROL]<br>(d r C -) | [1.5 INPUTS / OUTPUTS CFG]<br>( I - O -) | [1.6 COMMAND]<br>(C L L -) | [1.7 APPLICATION FUNCT.]<br>(F U N -) | [1.8 FAULT MANAGEMENT]<br>(F L T -) | [1.9 COMMUNICATION]<br>(C O M -) | [1.12 FACTORY SETTINGS]<br>(F L S -) | [4 PASSWORD]<br>(C O d -) |
| <i>b r A</i>   |                                 |                               |                             |                                  |  |                            | 136                                   |                                     |                                  |                                      |                           |
| <i>b r H 0</i> |                                 |                               |                             |                                  |  |                            | 160                                   |                                     |                                  |                                      |                           |
| <i>b r H 1</i> |                                 |                               |                             |                                  |  |                            | 160                                   |                                     |                                  |                                      |                           |
| <i>b r H 2</i> |                                 |                               |                             |                                  |  |                            | 161                                   |                                     |                                  |                                      |                           |
| <i>b r H 3</i> |                                 |                               |                             |                                  |  |                            | 161                                   |                                     |                                  |                                      |                           |
| <i>b r H 4</i> |                                 |                               |                             |                                  |  |                            | 161                                   |                                     |                                  |                                      |                           |
| <i>b r 0</i>   |                                 |                               |                             |                                  |  |                            |                                       | 231                                 |                                  |                                      |                           |
| <i>b r P</i>   |                                 |                               |                             |                                  |  |                            |                                       | 231                                 |                                  |                                      |                           |
| <i>b r r</i>   |                                 |                               |                             |                                  |  |                            | 161                                   |                                     |                                  |                                      |                           |
| <i>b r t</i>   |                                 |                               | 63                          |                                  |  |                            | 158                                   |                                     |                                  |                                      |                           |
| <i>b r U</i>   |                                 |                               |                             |                                  |  |                            |                                       | 231                                 |                                  |                                      |                           |
| <i>b S P</i>   |                                 |                               |                             |                                  | 89                                       |                            |                                       |                                     |                                  |                                      |                           |
| <i>b S t</i>   |                                 |                               |                             |                                  |  |                            | 157                                   |                                     |                                  |                                      |                           |
| <i>b U b</i>   |                                 |                               |                             |                                  |  |                            |                                       | 231                                 |                                  |                                      |                           |
| <i>C C F G</i> | 39                              |                               |                             |                                  |  |                            |                                       |                                     |                                  |                                      |                           |
| <i>C C S</i>   |                                 |                               |                             |                                  |  | 123                        |                                       |                                     |                                  |                                      |                           |
| <i>C d 1</i>   |                                 |                               |                             |                                  |  | 123                        |                                       |                                     |                                  |                                      |                           |
| <i>C d 2</i>   |                                 |                               |                             |                                  |  | 123                        |                                       |                                     |                                  |                                      |                           |
| <i>C F G</i>   | 39                              |                               |                             |                                  |  |                            |                                       |                                     |                                  |                                      |                           |
| <i>C F P S</i> |                                 | 49, 51                        |                             |                                  |  |                            |                                       |                                     |                                  |                                      |                           |
| <i>C H A 1</i> |                                 |                               |                             |                                  |  |                            | 195                                   |                                     |                                  |                                      |                           |
| <i>C H A 2</i> |                                 |                               |                             |                                  |  |                            | 195                                   |                                     |                                  |                                      |                           |
| <i>C H C F</i> |                                 |                               |                             |                                  |  | 122                        |                                       |                                     |                                  |                                      |                           |
| <i>C H N</i>   |                                 |                               |                             |                                  |  |                            | 199                                   |                                     |                                  |                                      |                           |
| <i>C L 2</i>   |                                 |                               | 59                          |                                  |  |                            | 184                                   |                                     |                                  |                                      |                           |
| <i>C L 1</i>   |                                 |                               | 59                          | 79                               |  |                            | 184                                   |                                     |                                  |                                      |                           |
| <i>C L L</i>   |                                 |                               |                             |                                  |  |                            |                                       | 225                                 |                                  |                                      |                           |
| <i>C L 0</i>   |                                 |                               |                             |                                  |  |                            | 168                                   |                                     |                                  |                                      |                           |
| <i>C L S</i>   |                                 |                               |                             |                                  |  |                            | 193                                   |                                     |                                  |                                      |                           |
| <i>C n F 1</i> |                                 |                               |                             |                                  |  |                            | 199                                   |                                     |                                  |                                      |                           |
| <i>C n F 2</i> |                                 |                               |                             |                                  |  |                            | 199                                   |                                     |                                  |                                      |                           |
| <i>C n F S</i> |                                 | 49, 51                        |                             |                                  |  |                            |                                       |                                     |                                  |                                      |                           |
| <i>C O d</i>   |                                 |                               |                             |                                  |  |                            |                                       |                                     |                                  |                                      | 249                       |
| <i>C O d 2</i> |                                 |                               |                             |                                  |  |                            |                                       |                                     |                                  |                                      | 249                       |
| <i>C O F</i>   |                                 |                               |                             |                                  |  |                            | 168                                   |                                     |                                  |                                      |                           |
| <i>C O L</i>   |                                 |                               |                             |                                  |  |                            |                                       | 225                                 |                                  |                                      |                           |



# Index of parameter codes

| Code    | Page                            |                               |                             |                                  |   |                            |                                       |                                     |                                  |                                      |                           |
|---------|---------------------------------|-------------------------------|-----------------------------|----------------------------------|---|----------------------------|---------------------------------------|-------------------------------------|----------------------------------|--------------------------------------|---------------------------|
|         | [1.1 SIMPLY START]<br>(S I P -) | [1.2 MONITORING]<br>(S U P -) | [1.3 SETTINGS]<br>(S E T -) | [1.4 MOTOR CONTROL]<br>(d r C -) | [1.5 INPUTS / OUTPUTS CFG]<br>(I - O -) | [1.6 COMMAND]<br>(C L L -) | [1.7 APPLICATION FUNCT.]<br>(F U n -) | [1.8 FAULT MANAGEMENT]<br>(F L t -) | [1.9 COMMUNICATION]<br>(C O m -) | [1.12 FACTORY SETTINGS]<br>(F L S -) | [4 PASSWORD]<br>(C O d -) |
| C D P   |                                 |                               |                             |                                  |   | 124                        |                                       |                                     |                                  |                                      |                           |
| C D r   |                                 |                               |                             |                                  |   |                            | 168                                   |                                     |                                  |                                      |                           |
| C P 1   |                                 |                               |                             |                                  |   |                            | 163                                   |                                     |                                  |                                      |                           |
| C P 2   |                                 |                               |                             |                                  |   |                            | 163                                   |                                     |                                  |                                      |                           |
| C r H 2 |                                 |                               |                             |                                  | 92                                      |                            |                                       |                                     |                                  |                                      |                           |
| C r H 3 |                                 |                               |                             |                                  | 93                                      |                            |                                       |                                     |                                  |                                      |                           |
| C r H 4 |                                 |                               |                             |                                  | 94                                      |                            |                                       |                                     |                                  |                                      |                           |
| C r L 2 |                                 |                               |                             |                                  | 92                                      |                            |                                       |                                     |                                  |                                      |                           |
| C r L 3 |                                 |                               |                             |                                  | 93                                      |                            |                                       |                                     |                                  |                                      |                           |
| C r L 4 |                                 |                               |                             |                                  | 94                                      |                            |                                       |                                     |                                  |                                      |                           |
| C S t   |                                 |                               |                             |                                  |   |                            |                                       |                                     |                                  |                                      | 249                       |
| C t d   |                                 |                               | 64                          |                                  |   |                            |                                       |                                     |                                  |                                      |                           |
| C t t   |                                 |                               |                             | 69                               |   |                            |                                       |                                     |                                  |                                      |                           |
| d A 2   |                                 |                               |                             |                                  |   |                            | 133                                   |                                     |                                  |                                      |                           |
| d A 3   |                                 |                               |                             |                                  |   |                            | 133                                   |                                     |                                  |                                      |                           |
| d A F   |                                 |                               |                             |                                  |   |                            | 192                                   |                                     |                                  |                                      |                           |
| d A L   |                                 |                               |                             |                                  |   |                            | 192                                   |                                     |                                  |                                      |                           |
| d A r   |                                 |                               |                             |                                  |   |                            | 192                                   |                                     |                                  |                                      |                           |
| d A S   |                                 |                               |                             |                                  |   |                            | 188                                   |                                     |                                  |                                      |                           |
| d b n   |                                 |                               |                             |                                  |   |                            | 180                                   |                                     |                                  |                                      |                           |
| d b P   |                                 |                               |                             |                                  |   |                            | 180                                   |                                     |                                  |                                      |                           |
| d b S   |                                 |                               |                             |                                  |   |                            | 188                                   |                                     |                                  |                                      |                           |
| d C F   |                                 |                               | 57                          |                                  |   |                            | 137                                   | 233                                 |                                  |                                      |                           |
| d C 1   |                                 |                               |                             |                                  |   |                            | 138                                   |                                     |                                  |                                      |                           |
| d C D   |                                 |                               |                             |                                  |   |                            | 209                                   |                                     |                                  |                                      |                           |
| d E 2   |                                 |                               | 53                          |                                  |   |                            | 136,<br>148                           |                                     |                                  |                                      |                           |
| d E C   | 42                              |                               | 53                          |                                  |   |                            | 134                                   |                                     |                                  |                                      |                           |
| d L b   |                                 |                               |                             |                                  |   |                            |                                       | 230                                 |                                  |                                      |                           |
| d L d   |                                 |                               |                             |                                  |   |                            |                                       | 230                                 |                                  |                                      |                           |
| d L r   |                                 |                               |                             |                                  |   |                            |                                       |                                     |                                  |                                      | 249                       |
| d D 1   |                                 |                               |                             |                                  | 105                                     |                            |                                       |                                     |                                  |                                      |                           |
| d D 1 d |                                 |                               |                             |                                  | 105                                     |                            |                                       |                                     |                                  |                                      |                           |
| d D 1 H |                                 |                               |                             |                                  | 105                                     |                            |                                       |                                     |                                  |                                      |                           |
| d D 1 S |                                 |                               |                             |                                  | 105                                     |                            |                                       |                                     |                                  |                                      |                           |
| d S F   |                                 |                               |                             |                                  |   |                            | 193                                   |                                     |                                  |                                      |                           |
| d S 1   |                                 |                               |                             |                                  |   |                            | 148                                   |                                     |                                  |                                      |                           |

# Index of parameter codes

| Code    | Page                            |                               |                             |                                  |   |                            |                                       |                                     |                                  |                                      |                           |
|---------|---------------------------------|-------------------------------|-----------------------------|----------------------------------|---|----------------------------|---------------------------------------|-------------------------------------|----------------------------------|--------------------------------------|---------------------------|
|         | [1.1 SIMPLY START]<br>(S I P -) | [1.2 MONITORING]<br>(S U P -) | [1.3 SETTINGS]<br>(S E T -) | [1.4 MOTOR CONTROL]<br>(D R C -) | [1.5 INPUTS / OUTPUTS CFG]<br>(I - O -) | [1.6 COMMAND]<br>(C L L -) | [1.7 APPLICATION FUNCT.]<br>(F U N -) | [1.8 FAULT MANAGEMENT]<br>(F L T -) | [1.9 COMMUNICATION]<br>(C O M -) | [1.12 FACTORY SETTINGS]<br>(F L S -) | [4 PASSWORD]<br>(C O D -) |
| d S P   |                                 |                               |                             |                                  |   |                            | 146                                   |                                     |                                  |                                      |                           |
| d t F   |                                 |                               |                             |                                  |   |                            | 206                                   |                                     |                                  |                                      |                           |
| E b D   |                                 |                               |                             |                                  |   |                            | 205                                   |                                     |                                  |                                      |                           |
| E C C   |                                 |                               |                             |                                  |   |                            |                                       | 226                                 |                                  |                                      |                           |
| E C t   |                                 |                               |                             |                                  |   |                            |                                       | 226                                 |                                  |                                      |                           |
| E F I   |                                 |                               |                             |                                  | 99                                      |                            |                                       |                                     |                                  |                                      |                           |
| E F r   |                                 |                               |                             |                                  | 99                                      |                            |                                       |                                     |                                  |                                      |                           |
| E I L   |                                 |                               |                             |                                  | 99                                      |                            |                                       |                                     |                                  |                                      |                           |
| E n R   |                                 |                               |                             | 78                               |   |                            |                                       |                                     |                                  |                                      |                           |
| E n C   |                                 |                               |                             | 76                               | 98                                      |                            |                                       |                                     |                                  |                                      |                           |
| E n S   |                                 |                               |                             | 75                               | 98                                      |                            |                                       |                                     |                                  |                                      |                           |
| E n U   |                                 |                               |                             | 76                               | 99                                      |                            |                                       |                                     |                                  |                                      |                           |
| E P L   |                                 |                               |                             |                                  |   |                            |                                       | 220                                 |                                  |                                      |                           |
| E r C D |                                 |                               |                             |                                  |   |                            |                                       |                                     | 236                              |                                      |                           |
| E t F   |                                 |                               |                             |                                  |   |                            |                                       | 220                                 |                                  |                                      |                           |
| F I     |                                 |                               |                             | 70                               |   |                            |                                       |                                     |                                  |                                      |                           |
| F 2     |                                 |                               |                             | 70                               |   |                            |                                       |                                     |                                  |                                      |                           |
| F 2 d   |                                 |                               | 65                          |                                  |   |                            |                                       |                                     |                                  |                                      |                           |
| F 3     |                                 |                               |                             | 70                               |   |                            |                                       |                                     |                                  |                                      |                           |
| F 4     |                                 |                               |                             | 70                               |   |                            |                                       |                                     |                                  |                                      |                           |
| F 5     |                                 |                               |                             | 70                               |   |                            |                                       |                                     |                                  |                                      |                           |
| F C P   |                                 |                               |                             | 71                               |   |                            |                                       |                                     |                                  |                                      |                           |
| F C S I |                                 |                               |                             |                                  |   |                            |                                       |                                     |                                  | 243                                  |                           |
| F d t   |                                 |                               |                             |                                  |   |                            |                                       | 228                                 |                                  |                                      |                           |
| F F t   |                                 |                               | 65                          |                                  |   |                            | 137                                   |                                     |                                  |                                      |                           |
| F L I   |                                 |                               |                             |                                  |   |                            | 150                                   |                                     |                                  |                                      |                           |
| F L D   |                                 |                               |                             |                                  |   |                            |                                       |                                     | 237                              |                                      |                           |
| F L D C |                                 |                               |                             |                                  |   |                            |                                       |                                     | 237                              |                                      |                           |
| F L D t |                                 |                               |                             |                                  |   |                            |                                       |                                     | 237                              |                                      |                           |
| F L r   |                                 |                               |                             |                                  |   |                            |                                       | 215                                 |                                  |                                      |                           |
| F L U   |                                 |                               | 60                          |                                  |   |                            | 150                                   |                                     |                                  |                                      |                           |
| F P I   |                                 |                               |                             |                                  |   |                            | 175                                   |                                     |                                  |                                      |                           |
| F 9 R   |                                 |                               |                             |                                  |   |                            |                                       | 228                                 |                                  |                                      |                           |
| F 9 C   |                                 |                               |                             |                                  |   |                            |                                       | 228                                 |                                  |                                      |                           |
| F 9 F   |                                 |                               |                             |                                  |   |                            |                                       | 228                                 |                                  |                                      |                           |
| F 9 L   |                                 |                               | 65                          |                                  |   |                            |                                       |                                     |                                  |                                      |                           |

# Index of parameter codes

| Code    | Page                            |                               |                             |                                  |  |                            |                                       |                                     |                                  |                                      |                           |
|---------|---------------------------------|-------------------------------|-----------------------------|----------------------------------|--|----------------------------|---------------------------------------|-------------------------------------|----------------------------------|--------------------------------------|---------------------------|
|         | [1.1 SIMPLY START]<br>(S I Π -) | [1.2 MONITORING]<br>(S U P -) | [1.3 SETTINGS]<br>(S E L -) | [1.4 MOTOR CONTROL]<br>(d r C -) | [1.5 INPUTS / OUTPUTS CFG]<br>( I - O -) | [1.6 COMMAND]<br>(C L L -) | [1.7 APPLICATION FUNCT.]<br>(F U n -) | [1.8 FAULT MANAGEMENT]<br>(F L L -) | [1.9 COMMUNICATION]<br>(C O Π -) | [1.12 FACTORY SETTINGS]<br>(F L 5 -) | [4 PASSWORD]<br>(C O d -) |
| F 9 5   |                                 | 49, 51                        |                             |                                  |  |                            |                                       |                                     |                                  |                                      |                           |
| F 9 t   |                                 |                               |                             |                                  |  |                            | 228                                   |                                     |                                  |                                      |                           |
| F r 1   |                                 |                               |                             |                                  |  | 122                        |                                       |                                     |                                  |                                      |                           |
| F r 1 b |                                 |                               |                             |                                  |  |                            | 132                                   |                                     |                                  |                                      |                           |
| F r 2   |                                 |                               |                             |                                  |  | 123                        |                                       |                                     |                                  |                                      |                           |
| F r H   |                                 | 49, 51                        |                             |                                  |  |                            |                                       |                                     |                                  |                                      |                           |
| F r 5   | 40                              |                               | 67                          |                                  |  |                            |                                       |                                     |                                  |                                      |                           |
| F r 5 5 |                                 |                               |                             | 74                               |  |                            |                                       |                                     |                                  |                                      |                           |
| F r t   |                                 |                               |                             |                                  |  |                            | 136                                   |                                     |                                  |                                      |                           |
| F r y - |                                 |                               |                             |                                  |  |                            |                                       |                                     |                                  | 243                                  |                           |
| F 5 t   |                                 |                               |                             |                                  |  |                            | 137                                   |                                     |                                  |                                      |                           |
| F t d   |                                 |                               | 65                          |                                  |  |                            |                                       |                                     |                                  |                                      |                           |
| G F 5   |                                 |                               |                             |                                  |  |                            |                                       |                                     |                                  | 243                                  |                           |
| G I E   |                                 |                               | 57                          | 78                               |  |                            |                                       |                                     |                                  |                                      |                           |
| G P E   |                                 |                               | 57                          | 78                               |  |                            |                                       |                                     |                                  |                                      |                           |
| H F F - |                                 |                               |                             |                                  |  |                            | 208                                   |                                     |                                  |                                      |                           |
| H L 5   |                                 |                               |                             |                                  |  |                            | 208                                   |                                     |                                  |                                      |                           |
| H 5 D   |                                 |                               |                             |                                  |  |                            | 168                                   |                                     |                                  |                                      |                           |
| H 5 P   | 42                              |                               | 54                          |                                  |  |                            |                                       |                                     |                                  |                                      |                           |
| I b r   |                                 |                               | 63                          |                                  |  |                            | 157                                   |                                     |                                  |                                      |                           |
| I b r A |                                 |                               |                             |                                  |  |                            | 163                                   |                                     |                                  |                                      |                           |
| I d A   |                                 |                               |                             | 73                               |  |                            |                                       |                                     |                                  |                                      |                           |
| I d C   |                                 |                               | 57                          |                                  |  |                            | 138                                   | 233                                 |                                  |                                      |                           |
| I d C 2 |                                 |                               | 57                          |                                  |  |                            | 138                                   | 233                                 |                                  |                                      |                           |
| I d Π   |                                 |                               |                             | 73                               |  |                            |                                       |                                     |                                  |                                      |                           |
| I n H   |                                 |                               |                             |                                  |  |                            |                                       | 224                                 |                                  |                                      |                           |
| I n r   |                                 |                               | 53                          |                                  |  |                            | 134                                   |                                     |                                  |                                      |                           |
| I n 5 P |                                 |                               |                             | 67                               |  |                            |                                       |                                     |                                  |                                      |                           |
| I n t P |                                 |                               |                             |                                  |  |                            | 182                                   |                                     |                                  |                                      |                           |
| I P L   | 40                              |                               |                             |                                  |  |                            |                                       | 218                                 |                                  |                                      |                           |
| I r d   |                                 |                               | 63                          |                                  |  |                            | 157                                   |                                     |                                  |                                      |                           |
| I t H   | 42                              |                               | 54                          |                                  |  |                            |                                       |                                     |                                  |                                      |                           |
| J d C   |                                 |                               | 64                          |                                  |  |                            | 159                                   |                                     |                                  |                                      |                           |
| J G F   |                                 |                               | 60                          |                                  |  |                            | 141                                   |                                     |                                  |                                      |                           |
| J G t   |                                 |                               | 60                          |                                  |  |                            | 141                                   |                                     |                                  |                                      |                           |
| J O G   |                                 |                               |                             |                                  |  |                            | 141                                   |                                     |                                  |                                      |                           |

# Index of parameter codes

| Code                          | Page                            |                               |                             |                                  |  |                            |                                       |                                     |                                  |                                      |                           |
|-------------------------------|---------------------------------|-------------------------------|-----------------------------|----------------------------------|--|----------------------------|---------------------------------------|-------------------------------------|----------------------------------|--------------------------------------|---------------------------|
|                               | [1.1 SIMPLY START]<br>(5 / П -) | [1.2 MONITORING]<br>(5 U P -) | [1.3 SETTINGS]<br>(5 E L -) | [1.4 MOTOR CONTROL]<br>(d r C -) | [1.5 INPUTS / OUTPUTS CFG]<br>( I - D -) | [1.6 COMMAND]<br>(C L L -) | [1.7 APPLICATION FUNCT.]<br>(F U n -) | [1.8 FAULT MANAGEMENT]<br>(F L L -) | [1.9 COMMUNICATION]<br>(C O П -) | [1.12 FACTORY SETTINGS]<br>(F L 5 -) | [4 PASSWORD]<br>(C O d -) |
| L 1A to L 14A                 |                                 | 50                            |                             |                                  | 87                                       |                            |                                       |                                     |                                  |                                      |                           |
| L 1d to L 14d                 |                                 |                               |                             |                                  | 87                                       |                            |                                       |                                     |                                  |                                      |                           |
| L A F                         |                                 |                               |                             |                                  |  |                            | 152                                   |                                     |                                  |                                      |                           |
| L A r                         |                                 |                               |                             |                                  |  |                            | 152                                   |                                     |                                  |                                      |                           |
| L A 5                         |                                 |                               |                             |                                  |  |                            | 152                                   |                                     |                                  |                                      |                           |
| L b A                         |                                 |                               |                             | 82                               |  |                            |                                       |                                     |                                  |                                      |                           |
| L b C                         |                                 |                               | 65                          | 82                               |  |                            |                                       |                                     |                                  |                                      |                           |
| L b C 1                       |                                 |                               |                             | 84                               |  |                            |                                       |                                     |                                  |                                      |                           |
| L b C 2                       |                                 |                               |                             | 84                               |  |                            |                                       |                                     |                                  |                                      |                           |
| L b C 3                       |                                 |                               |                             | 84                               |  |                            |                                       |                                     |                                  |                                      |                           |
| L b F                         |                                 |                               |                             | 84                               |  |                            |                                       |                                     |                                  |                                      |                           |
| L C 2                         |                                 |                               |                             |                                  |  |                            | 184                                   |                                     |                                  |                                      |                           |
| L C r                         |                                 | 49, 51                        |                             |                                  |  |                            |                                       |                                     |                                  |                                      |                           |
| L C t                         |                                 |                               |                             |                                  |  |                            | 186                                   |                                     |                                  |                                      |                           |
| L d 5                         |                                 |                               |                             | 72                               |  |                            |                                       |                                     |                                  |                                      |                           |
| L E 5                         |                                 |                               |                             |                                  |  |                            | 186                                   |                                     |                                  |                                      |                           |
| L E t                         |                                 |                               |                             |                                  |  |                            |                                       | 220                                 |                                  |                                      |                           |
| L F A                         |                                 |                               |                             | 73                               |  |                            |                                       |                                     |                                  |                                      |                           |
| L F F                         |                                 |                               |                             |                                  |  |                            |                                       | 233                                 |                                  |                                      |                           |
| L F L 2<br>L F L 3<br>L F L 4 |                                 |                               |                             |                                  |  |                            |                                       | 223                                 |                                  |                                      |                           |
| L F П                         |                                 |                               |                             | 73                               |  |                            |                                       |                                     |                                  |                                      |                           |
| L 15 1                        |                                 | 50                            |                             |                                  |  |                            |                                       |                                     |                                  |                                      |                           |
| L 15 2                        |                                 | 50                            |                             |                                  |  |                            |                                       |                                     |                                  |                                      |                           |
| L L C                         |                                 |                               |                             |                                  |  |                            | 186                                   |                                     |                                  |                                      |                           |
| L D 1                         |                                 |                               |                             |                                  | 103                                      |                            |                                       |                                     |                                  |                                      |                           |
| L D 1d                        |                                 |                               |                             |                                  | 103                                      |                            |                                       |                                     |                                  |                                      |                           |
| L D 1H                        |                                 |                               |                             |                                  | 103                                      |                            |                                       |                                     |                                  |                                      |                           |
| L D 15                        |                                 |                               |                             |                                  | 103                                      |                            |                                       |                                     |                                  |                                      |                           |
| L D 2                         |                                 |                               |                             |                                  | 103                                      |                            |                                       |                                     |                                  |                                      |                           |
| L D 2d                        |                                 |                               |                             |                                  | 103                                      |                            |                                       |                                     |                                  |                                      |                           |
| L D 2H                        |                                 |                               |                             |                                  | 103                                      |                            |                                       |                                     |                                  |                                      |                           |
| L D 25                        |                                 |                               |                             |                                  | 103                                      |                            |                                       |                                     |                                  |                                      |                           |
| L D 3                         |                                 |                               |                             |                                  | 104                                      |                            |                                       |                                     |                                  |                                      |                           |
| L D 3d                        |                                 |                               |                             |                                  | 104                                      |                            |                                       |                                     |                                  |                                      |                           |
| L D 3H                        |                                 |                               |                             |                                  | 104                                      |                            |                                       |                                     |                                  |                                      |                           |

# Index of parameter codes

| Code | Page                            |                             |                           |                                |   |                          |                                     |                                   |                                |                                    |                         |
|------|---------------------------------|-----------------------------|---------------------------|--------------------------------|---|--------------------------|-------------------------------------|-----------------------------------|--------------------------------|------------------------------------|-------------------------|
|      | [1.1 SIMPLY START]<br>(5 / П -) | [1.2 MONITORING]<br>(SUP -) | [1.3 SETTINGS]<br>(SET -) | [1.4 MOTOR CONTROL]<br>(drc -) | [1.5 INPUTS / OUTPUTS CFG]<br>(I - O -) | [1.6 COMMAND]<br>(CLL -) | [1.7 APPLICATION FUNCT.]<br>(FUN -) | [1.8 FAULT MANAGEMENT]<br>(FLT -) | [1.9 COMMUNICATION]<br>(COP -) | [1.12 FACTORY SETTINGS]<br>(FCS -) | [4 PASSWORD]<br>(CPD -) |
| L035 |                                 |                             |                           |                                | <a href="#">104</a>                     |                          |                                     |                                   |                                |                                    |                         |
| L04  |                                 |                             |                           |                                | <a href="#">104</a>                     |                          |                                     |                                   |                                |                                    |                         |
| L04d |                                 |                             |                           |                                | <a href="#">104</a>                     |                          |                                     |                                   |                                |                                    |                         |
| L04H |                                 |                             |                           |                                | <a href="#">104</a>                     |                          |                                     |                                   |                                |                                    |                         |
| L045 |                                 |                             |                           |                                | <a href="#">104</a>                     |                          |                                     |                                   |                                |                                    |                         |
| LP1  |                                 |                             |                           |                                |   |                          | <a href="#">163</a>                 |                                   |                                |                                    |                         |
| LP2  |                                 |                             |                           |                                |   |                          | <a href="#">163</a>                 |                                   |                                |                                    |                         |
| L95  |                                 |                             |                           | <a href="#">72</a>             |   |                          |                                     |                                   |                                |                                    |                         |
| L5P  | <a href="#">42</a>              |                             | <a href="#">54</a>        |                                |   |                          |                                     |                                   |                                |                                    |                         |
| ПA2  |                                 |                             |                           |                                |   |                          | <a href="#">133</a>                 |                                   |                                |                                    |                         |
| ПA3  |                                 |                             |                           |                                |   |                          | <a href="#">133</a>                 |                                   |                                |                                    |                         |
| ПFr  |                                 | <a href="#">49, 51</a>      | <a href="#">62</a>        |                                |   |                          |                                     |                                   |                                |                                    |                         |
| ППF  |                                 | <a href="#">49, 51</a>      |                           |                                |   |                          |                                     |                                   |                                |                                    |                         |
| нCA1 |                                 |                             |                           |                                |   |                          |                                     |                                   | <a href="#">235</a>            |                                    |                         |
| нCA2 |                                 |                             |                           |                                |   |                          |                                     |                                   | <a href="#">235</a>            |                                    |                         |
| нCA3 |                                 |                             |                           |                                |   |                          |                                     |                                   | <a href="#">235</a>            |                                    |                         |
| нCA4 |                                 |                             |                           |                                |   |                          |                                     |                                   | <a href="#">235</a>            |                                    |                         |
| нCA5 |                                 |                             |                           |                                |   |                          |                                     |                                   | <a href="#">235</a>            |                                    |                         |
| нCA6 |                                 |                             |                           |                                |   |                          |                                     |                                   | <a href="#">235</a>            |                                    |                         |
| нCA7 |                                 |                             |                           |                                |   |                          |                                     |                                   | <a href="#">235</a>            |                                    |                         |
| нCAB |                                 |                             |                           |                                |   |                          |                                     |                                   | <a href="#">235</a>            |                                    |                         |
| нCr  | <a href="#">40</a>              |                             | <a href="#">67</a>        |                                |   |                          |                                     |                                   |                                |                                    |                         |
| нCr5 |                                 |                             |                           | <a href="#">72</a>             |   |                          |                                     |                                   |                                |                                    |                         |
| нL5  |                                 |                             |                           |                                |   |                          | <a href="#">193</a>                 |                                   |                                |                                    |                         |
| нПА1 |                                 |                             |                           |                                |   |                          |                                     |                                   | <a href="#">235</a>            |                                    |                         |
| нПА2 |                                 |                             |                           |                                |   |                          |                                     |                                   | <a href="#">235</a>            |                                    |                         |
| нПА3 |                                 |                             |                           |                                |   |                          |                                     |                                   | <a href="#">235</a>            |                                    |                         |
| нПА4 |                                 |                             |                           |                                |   |                          |                                     |                                   | <a href="#">235</a>            |                                    |                         |
| нПА5 |                                 |                             |                           |                                |   |                          |                                     |                                   | <a href="#">235</a>            |                                    |                         |
| нПА6 |                                 |                             |                           |                                |   |                          |                                     |                                   | <a href="#">235</a>            |                                    |                         |
| нПА7 |                                 |                             |                           |                                |   |                          |                                     |                                   | <a href="#">235</a>            |                                    |                         |
| нПAB |                                 |                             |                           |                                |   |                          |                                     |                                   | <a href="#">235</a>            |                                    |                         |
| нPr  | <a href="#">40</a>              |                             | <a href="#">67</a>        |                                |   |                          |                                     |                                   |                                |                                    |                         |
| нrd  |                                 |                             |                           | <a href="#">80</a>             |   |                          |                                     |                                   |                                |                                    |                         |
| нSL  |                                 |                             |                           | <a href="#">73</a>             |   |                          |                                     |                                   |                                |                                    |                         |
| нSP  | <a href="#">40</a>              |                             | <a href="#">67</a>        |                                |   |                          |                                     |                                   |                                |                                    |                         |

# Index of parameter codes

| Code    | Page                            |                               |                             |                                  |   |                            |                                       |                                     |                                  |                                      |                           |
|---------|---------------------------------|-------------------------------|-----------------------------|----------------------------------|---|----------------------------|---------------------------------------|-------------------------------------|----------------------------------|--------------------------------------|---------------------------|
|         | [1.1 SIMPLY START]<br>(S I P -) | [1.2 MONITORING]<br>(S U P -) | [1.3 SETTINGS]<br>(S E T -) | [1.4 MOTOR CONTROL]<br>(D R C -) | [1.5 INPUTS / OUTPUTS CFG]<br>(I - O -) | [1.6 COMMAND]<br>(C L L -) | [1.7 APPLICATION FUNCT.]<br>(F U N -) | [1.8 FAULT MANAGEMENT]<br>(F L T -) | [1.9 COMMUNICATION]<br>(C O M -) | [1.12 FACTORY SETTINGS]<br>(F L S -) | [4 PASSWORD]<br>(C O D -) |
| n S P 5 |                                 |                               |                             | 72                               |   |                            |                                       |                                     |                                  |                                      |                           |
| n S t   |                                 |                               |                             |                                  |   |                            | 137                                   |                                     |                                  |                                      |                           |
| o D 2   |                                 | 49, 51                        |                             |                                  |   |                            |                                       |                                     |                                  |                                      |                           |
| o D 3   |                                 | 49, 51                        |                             |                                  |   |                            |                                       |                                     |                                  |                                      |                           |
| o D 4   |                                 | 49, 51                        |                             |                                  |   |                            |                                       |                                     |                                  |                                      |                           |
| o D 5   |                                 | 49, 51                        |                             |                                  |   |                            |                                       |                                     |                                  |                                      |                           |
| o D 6   |                                 | 49, 51                        |                             |                                  |   |                            |                                       |                                     |                                  |                                      |                           |
| O C C   |                                 |                               |                             |                                  |   |                            | 188                                   |                                     |                                  |                                      |                           |
| O d t   |                                 |                               |                             |                                  |   |                            |                                       | 217                                 |                                  |                                      |                           |
| O F I   |                                 |                               |                             | 79                               |   |                            |                                       |                                     |                                  |                                      |                           |
| O H L   |                                 |                               |                             |                                  |   |                            |                                       | 218                                 |                                  |                                      |                           |
| O L L   |                                 |                               |                             |                                  |   |                            |                                       | 217                                 |                                  |                                      |                           |
| O P L   |                                 |                               |                             |                                  |   |                            |                                       | 217                                 |                                  |                                      |                           |
| O P r   |                                 | 49, 51                        |                             |                                  |   |                            |                                       |                                     |                                  |                                      |                           |
| O S P   |                                 |                               |                             |                                  |   |                            | 168                                   |                                     |                                  |                                      |                           |
| P R H   |                                 |                               | 62                          |                                  |   |                            | 174                                   |                                     |                                  |                                      |                           |
| P R L   |                                 |                               | 62                          |                                  |   |                            | 174                                   |                                     |                                  |                                      |                           |
| P R S   |                                 |                               |                             |                                  |   |                            | 193                                   |                                     |                                  |                                      |                           |
| P R U   |                                 |                               |                             |                                  |   |                            | 175                                   |                                     |                                  |                                      |                           |
| P E r   |                                 |                               | 63                          |                                  |   |                            | 174                                   |                                     |                                  |                                      |                           |
| P E S   |                                 |                               |                             |                                  |   |                            | 163                                   |                                     |                                  |                                      |                           |
| P F I   |                                 |                               |                             |                                  | 96                                      |                            |                                       |                                     |                                  |                                      |                           |
| P F r   |                                 |                               |                             |                                  | 96                                      |                            |                                       |                                     |                                  |                                      |                           |
| P G A   |                                 |                               |                             |                                  | 99                                      |                            |                                       |                                     |                                  |                                      |                           |
| P G I   |                                 |                               |                             | 75                               | 99                                      |                            |                                       |                                     |                                  |                                      |                           |
| P H S   |                                 |                               |                             | 72                               |   |                            |                                       |                                     |                                  |                                      |                           |
| P H r   | 41                              |                               |                             | 68                               |   |                            |                                       |                                     |                                  |                                      |                           |
| P I R   |                                 |                               |                             |                                  | 96                                      |                            |                                       |                                     |                                  |                                      |                           |
| P I C   |                                 |                               |                             |                                  |   |                            | 174                                   |                                     |                                  |                                      |                           |
| P I F   |                                 |                               |                             |                                  |   |                            | 173                                   |                                     |                                  |                                      |                           |
| P I F 1 |                                 |                               |                             |                                  |   |                            | 173                                   |                                     |                                  |                                      |                           |
| P I F 2 |                                 |                               |                             |                                  |   |                            | 173                                   |                                     |                                  |                                      |                           |
| P I I   |                                 |                               |                             |                                  |   |                            | 173                                   |                                     |                                  |                                      |                           |
| P I L   |                                 |                               |                             |                                  | 96                                      |                            |                                       |                                     |                                  |                                      |                           |
| P I N   |                                 |                               |                             |                                  |   |                            | 175                                   |                                     |                                  |                                      |                           |
| P I P 1 |                                 |                               |                             |                                  |   |                            | 173                                   |                                     |                                  |                                      |                           |

# Index of parameter codes

| Code    | Page                            |                               |                             |                                  |  |                            |                                       |                                     |                                  |                                      |                           |
|---------|---------------------------------|-------------------------------|-----------------------------|----------------------------------|--|----------------------------|---------------------------------------|-------------------------------------|----------------------------------|--------------------------------------|---------------------------|
|         | [1.1 SIMPLY START]<br>(S I P -) | [1.2 MONITORING]<br>(S U P -) | [1.3 SETTINGS]<br>(S E T -) | [1.4 MOTOR CONTROL]<br>(D R C -) | [1.5 INPUTS / OUTPUTS CFG]<br>( I - O -) | [1.6 COMMAND]<br>(C L L -) | [1.7 APPLICATION FUNCT.]<br>(F U N -) | [1.8 FAULT MANAGEMENT]<br>(F L T -) | [1.9 COMMUNICATION]<br>(C O M -) | [1.12 FACTORY SETTINGS]<br>(F L S -) | [4 PASSWORD]<br>(C O D -) |
| P I P 2 |                                 |                               |                             |                                  |  |                            | 173                                   |                                     |                                  |                                      |                           |
| P I 5   |                                 |                               |                             |                                  |  |                            | 174                                   |                                     |                                  |                                      |                           |
| P D H   |                                 |                               | 62                          |                                  |  |                            | 174                                   |                                     |                                  |                                      |                           |
| P D L   |                                 |                               | 62                          |                                  |  |                            | 174                                   |                                     |                                  |                                      |                           |
| P P 1   |                                 |                               |                             |                                  |  |                            |                                       | 232                                 |                                  |                                      |                           |
| P P n   |                                 |                               |                             | 73                               |  |                            |                                       |                                     |                                  |                                      |                           |
| P P n 5 |                                 |                               |                             | 72                               |  |                            |                                       |                                     |                                  |                                      |                           |
| P r 2   |                                 |                               |                             |                                  |  |                            | 177                                   |                                     |                                  |                                      |                           |
| P r 4   |                                 |                               |                             |                                  |  |                            | 177                                   |                                     |                                  |                                      |                           |
| P r P   |                                 |                               | 62                          |                                  |  |                            | 174                                   |                                     |                                  |                                      |                           |
| P S 1 - |                                 |                               |                             |                                  |  |                            | 195                                   |                                     |                                  |                                      |                           |
| P S 2 - |                                 |                               |                             |                                  |  |                            | 196                                   |                                     |                                  |                                      |                           |
| P S 3 - |                                 |                               |                             |                                  |  |                            | 196                                   |                                     |                                  |                                      |                           |
| P S 2   |                                 |                               |                             |                                  |  |                            | 143                                   |                                     |                                  |                                      |                           |
| P S 4   |                                 |                               |                             |                                  |  |                            | 143                                   |                                     |                                  |                                      |                           |
| P S 8   |                                 |                               |                             |                                  |  |                            | 143                                   |                                     |                                  |                                      |                           |
| P S 1 6 |                                 |                               |                             |                                  |  |                            | 143                                   |                                     |                                  |                                      |                           |
| P S r   |                                 |                               | 63                          |                                  |  |                            | 175                                   |                                     |                                  |                                      |                           |
| P S t   |                                 |                               |                             |                                  |  | 122                        |                                       |                                     |                                  |                                      |                           |
| P t C 1 |                                 |                               |                             |                                  |  |                            |                                       | 212                                 |                                  |                                      |                           |
| P t C 2 |                                 |                               |                             |                                  |  |                            |                                       | 212                                 |                                  |                                      |                           |
| P t C L |                                 |                               |                             |                                  |  |                            |                                       | 212                                 |                                  |                                      |                           |
| P t H   |                                 | 49, 51                        |                             |                                  |  |                            |                                       |                                     |                                  |                                      |                           |
| q 5 H   |                                 |                               | 64                          |                                  |  |                            | 205                                   |                                     |                                  |                                      |                           |
| q 5 L   |                                 |                               | 64                          |                                  |  |                            | 205                                   |                                     |                                  |                                      |                           |
| r 1     |                                 |                               |                             |                                  | 100                                      |                            |                                       |                                     |                                  |                                      |                           |
| r 1 d   |                                 |                               |                             |                                  | 101                                      |                            |                                       |                                     |                                  |                                      |                           |
| r 1 H   |                                 |                               |                             |                                  | 101                                      |                            |                                       |                                     |                                  |                                      |                           |
| r 1 5   |                                 |                               |                             |                                  | 101                                      |                            |                                       |                                     |                                  |                                      |                           |
| r 2     |                                 |                               |                             |                                  | 101                                      |                            |                                       |                                     |                                  |                                      |                           |
| r 2 d   |                                 |                               |                             |                                  | 101                                      |                            |                                       |                                     |                                  |                                      |                           |
| r 2 H   |                                 |                               |                             |                                  | 101                                      |                            |                                       |                                     |                                  |                                      |                           |
| r 2 5   |                                 |                               |                             |                                  | 101                                      |                            |                                       |                                     |                                  |                                      |                           |
| r 3     |                                 |                               |                             |                                  | 102                                      |                            |                                       |                                     |                                  |                                      |                           |
| r 3 d   |                                 |                               |                             |                                  | 102                                      |                            |                                       |                                     |                                  |                                      |                           |
| r 3 H   |                                 |                               |                             |                                  | 102                                      |                            |                                       |                                     |                                  |                                      |                           |

# Index of parameter codes

| Code    | Page                            |                               |                             |                                  |  |                            |                                       |                                     |                                  |                                      |                           |
|---------|---------------------------------|-------------------------------|-----------------------------|----------------------------------|--|----------------------------|---------------------------------------|-------------------------------------|----------------------------------|--------------------------------------|---------------------------|
|         | [1.1 SIMPLY START]<br>(S I Π -) | [1.2 MONITORING]<br>(S U P -) | [1.3 SETTINGS]<br>(S E t -) | [1.4 MOTOR CONTROL]<br>(d r C -) | [1.5 INPUTS / OUTPUTS CFG]<br>( I - O -) | [1.6 COMMAND]<br>(C t L -) | [1.7 APPLICATION FUNCT.]<br>(F U n -) | [1.8 FAULT MANAGEMENT]<br>(F L t -) | [1.9 COMMUNICATION]<br>(C O Π -) | [1.12 FACTORY SETTINGS]<br>(F L 5 -) | [4 PASSWORD]<br>(C O d -) |
| r 3 5   |                                 |                               |                             |                                  | <a href="#">102</a>                      |                            |                                       |                                     |                                  |                                      |                           |
| r 4     |                                 |                               |                             |                                  | <a href="#">102</a>                      |                            |                                       |                                     |                                  |                                      |                           |
| r 4 d   |                                 |                               |                             |                                  | <a href="#">102</a>                      |                            |                                       |                                     |                                  |                                      |                           |
| r 4 H   |                                 |                               |                             |                                  | <a href="#">102</a>                      |                            |                                       |                                     |                                  |                                      |                           |
| r 4 5   |                                 |                               |                             |                                  | <a href="#">102</a>                      |                            |                                       |                                     |                                  |                                      |                           |
| r R P   |                                 |                               |                             | <a href="#">78</a>               |  |                            |                                       |                                     |                                  |                                      |                           |
| r C A   |                                 |                               |                             |                                  |  |                            | <a href="#">188</a>                   |                                     |                                  |                                      |                           |
| r C b   |                                 |                               |                             |                                  |  |                            | <a href="#">132</a>                   |                                     |                                  |                                      |                           |
| r d G   |                                 |                               | <a href="#">62</a>          |                                  |  |                            | <a href="#">174</a>                   |                                     |                                  |                                      |                           |
| r F C   |                                 |                               |                             |                                  |  | <a href="#">123</a>        |                                       |                                     |                                  |                                      |                           |
| r F r   |                                 | <a href="#">49, 51</a>        |                             |                                  |  |                            |                                       |                                     |                                  |                                      |                           |
| r F t - |                                 |                               |                             |                                  |  |                            | <a href="#">207</a>                   |                                     |                                  |                                      |                           |
| r I G   |                                 |                               | <a href="#">62</a>          |                                  |  |                            | <a href="#">174</a>                   |                                     |                                  |                                      |                           |
| r I n   |                                 |                               |                             |                                  |  | <a href="#">122</a>        |                                       |                                     |                                  |                                      |                           |
| r P     |                                 |                               |                             |                                  |  |                            |                                       | <a href="#">213</a>                 |                                  |                                      |                           |
| r P 2   |                                 |                               | <a href="#">63</a>          |                                  |  |                            | <a href="#">177</a>                   |                                     |                                  |                                      |                           |
| r P 3   |                                 |                               | <a href="#">63</a>          |                                  |  |                            | <a href="#">177</a>                   |                                     |                                  |                                      |                           |
| r P 4   |                                 |                               | <a href="#">63</a>          |                                  |  |                            | <a href="#">177</a>                   |                                     |                                  |                                      |                           |
| r P A   |                                 |                               |                             |                                  |  |                            |                                       | <a href="#">213</a>                 |                                  |                                      |                           |
| r P C   |                                 | <a href="#">49, 51</a>        |                             |                                  |  |                            |                                       |                                     |                                  |                                      |                           |
| r P E   |                                 | <a href="#">49, 51</a>        |                             |                                  |  |                            |                                       |                                     |                                  |                                      |                           |
| r P F   |                                 | <a href="#">49, 51</a>        |                             |                                  |  |                            |                                       |                                     |                                  |                                      |                           |
| r P G   |                                 |                               | <a href="#">62</a>          |                                  |  |                            | <a href="#">173</a>                   |                                     |                                  |                                      |                           |
| r P I   |                                 |                               |                             |                                  |  |                            | <a href="#">173</a>                   |                                     |                                  |                                      |                           |
| r P D   |                                 | <a href="#">49, 51</a>        |                             |                                  |  |                            |                                       |                                     |                                  |                                      |                           |
| r P 5   |                                 |                               |                             |                                  |  |                            | <a href="#">136</a>                   |                                     |                                  |                                      |                           |
| r P t   |                                 |                               |                             |                                  |  |                            | <a href="#">134</a>                   |                                     |                                  |                                      |                           |
| r r 5   |                                 |                               |                             |                                  | <a href="#">86</a>                       |                            |                                       |                                     |                                  |                                      |                           |
| r S A   |                                 |                               |                             | <a href="#">73</a>               |  |                            |                                       |                                     |                                  |                                      |                           |
| r S A 5 |                                 |                               |                             | <a href="#">72</a>               |  |                            |                                       |                                     |                                  |                                      |                           |
| r S d   |                                 |                               |                             |                                  |  |                            | <a href="#">168</a>                   |                                     |                                  |                                      |                           |
| r S F   |                                 |                               |                             |                                  |  |                            |                                       | <a href="#">213</a>                 |                                  |                                      |                           |
| r S L   |                                 |                               |                             |                                  |  |                            | <a href="#">176</a>                   |                                     |                                  |                                      |                           |
| r S Π   |                                 |                               |                             | <a href="#">73</a>               |  |                            |                                       |                                     |                                  |                                      |                           |
| r S Π 5 |                                 |                               |                             | <a href="#">74</a>               |  |                            |                                       |                                     |                                  |                                      |                           |
| r S P   |                                 |                               |                             |                                  |  |                            | <a href="#">207</a>                   |                                     |                                  |                                      |                           |



# Index of parameter codes

| Code    | Page                            |                               |                             |                                  |   |                            |                                       |                                     |                                  |                                      |                           |
|---------|---------------------------------|-------------------------------|-----------------------------|----------------------------------|---|----------------------------|---------------------------------------|-------------------------------------|----------------------------------|--------------------------------------|---------------------------|
|         | [1.1 SIMPLY START]<br>(S I P -) | [1.2 MONITORING]<br>(S U P -) | [1.3 SETTINGS]<br>(S E T -) | [1.4 MOTOR CONTROL]<br>(D R C -) | [1.5 INPUTS / OUTPUTS CFG]<br>(I - O -) | [1.6 COMMAND]<br>(C L L -) | [1.7 APPLICATION FUNCT.]<br>(F U N -) | [1.8 FAULT MANAGEMENT]<br>(F L T -) | [1.9 COMMUNICATION]<br>(C O M -) | [1.12 FACTORY SETTINGS]<br>(F L S -) | [4 PASSWORD]<br>(C O D -) |
| r S t L |                                 |                               |                             |                                  |   |                            | 168                                   |                                     |                                  |                                      |                           |
| r S U   |                                 |                               |                             |                                  |   |                            | 207                                   |                                     |                                  |                                      |                           |
| r t H   |                                 | 49, 51                        |                             |                                  |   |                            |                                       |                                     |                                  |                                      |                           |
| r t O   |                                 |                               |                             |                                  |   |                            | 180                                   |                                     |                                  |                                      |                           |
| r t r   |                                 |                               |                             |                                  |   |                            | 206                                   |                                     |                                  |                                      |                           |
| S R 2   |                                 |                               |                             |                                  |   |                            | 133                                   |                                     |                                  |                                      |                           |
| S R 3   |                                 |                               |                             |                                  |   |                            | 133                                   |                                     |                                  |                                      |                           |
| S R F   |                                 |                               |                             |                                  |   |                            | 192                                   |                                     |                                  |                                      |                           |
| S R L   |                                 |                               |                             |                                  |   |                            | 192                                   |                                     |                                  |                                      |                           |
| S R r   |                                 |                               |                             |                                  |   |                            | 192                                   |                                     |                                  |                                      |                           |
| S R t   |                                 |                               |                             |                                  |   |                            |                                       | 219                                 |                                  |                                      |                           |
| S C L   |                                 |                               |                             |                                  |   |                            | 168                                   |                                     |                                  |                                      |                           |
| S C S I |                                 |                               |                             |                                  |   |                            |                                       |                                     |                                  | 243                                  |                           |
| S d C 1 |                                 |                               | 58                          |                                  |   |                            | 139,<br>158                           |                                     |                                  |                                      |                           |
| S d C 2 |                                 |                               | 58                          |                                  |   |                            | 139                                   |                                     |                                  |                                      |                           |
| S d d   |                                 |                               |                             |                                  |   |                            |                                       | 226                                 |                                  |                                      |                           |
| S F C   |                                 |                               | 54                          |                                  |   |                            |                                       |                                     |                                  |                                      |                           |
| S F d   |                                 |                               |                             |                                  |   |                            | 193                                   |                                     |                                  |                                      |                           |
| S F r   |                                 |                               | 59                          | 79                               |   |                            |                                       |                                     |                                  |                                      |                           |
| S I t   |                                 |                               | 54                          |                                  |   |                            |                                       |                                     |                                  |                                      |                           |
| S L L   |                                 |                               |                             |                                  |   |                            |                                       | 225                                 |                                  |                                      |                           |
| S L P   |                                 |                               | 57                          | 72                               |   |                            |                                       |                                     |                                  |                                      |                           |
| S n C   |                                 |                               |                             |                                  |   |                            | 206                                   |                                     |                                  |                                      |                           |
| S O P   |                                 |                               |                             | 80                               |   |                            |                                       |                                     |                                  |                                      |                           |
| S P 2   |                                 |                               | 61                          |                                  |   |                            | 144                                   |                                     |                                  |                                      |                           |
| S P 3   |                                 |                               | 61                          |                                  |   |                            | 144                                   |                                     |                                  |                                      |                           |
| S P 4   |                                 |                               | 61                          |                                  |   |                            | 144                                   |                                     |                                  |                                      |                           |
| S P 5   |                                 |                               | 61                          |                                  |   |                            | 144                                   |                                     |                                  |                                      |                           |
| S P 6   |                                 |                               | 61                          |                                  |   |                            | 144                                   |                                     |                                  |                                      |                           |
| S P 7   |                                 |                               | 61                          |                                  |   |                            | 144                                   |                                     |                                  |                                      |                           |
| S P 8   |                                 |                               | 61                          |                                  |   |                            | 144                                   |                                     |                                  |                                      |                           |
| S P 9   |                                 |                               | 61                          |                                  |   |                            | 144                                   |                                     |                                  |                                      |                           |
| S P 10  |                                 |                               | 61                          |                                  |   |                            | 144                                   |                                     |                                  |                                      |                           |
| S P 11  |                                 |                               | 61                          |                                  |   |                            | 144                                   |                                     |                                  |                                      |                           |
| S P 12  |                                 |                               | 61                          |                                  |   |                            | 144                                   |                                     |                                  |                                      |                           |
| S P 13  |                                 |                               | 61                          |                                  |   |                            | 144                                   |                                     |                                  |                                      |                           |

# Index of parameter codes

| Code    | Page                            |                               |                             |                                  |   |                            |                                       |                                     |                                  |                                      |                           |
|---------|---------------------------------|-------------------------------|-----------------------------|----------------------------------|---|----------------------------|---------------------------------------|-------------------------------------|----------------------------------|--------------------------------------|---------------------------|
|         | [1.1 SIMPLY START]<br>(S I P -) | [1.2 MONITORING]<br>(S U P -) | [1.3 SETTINGS]<br>(S E T -) | [1.4 MOTOR CONTROL]<br>(D R C -) | [1.5 INPUTS / OUTPUTS CFG]<br>(I - O -) | [1.6 COMMAND]<br>(C L L -) | [1.7 APPLICATION FUNCT.]<br>(F U N -) | [1.8 FAULT MANAGEMENT]<br>(F L T -) | [1.9 COMMUNICATION]<br>(C O M -) | [1.12 FACTORY SETTINGS]<br>(F L S -) | [4 PASSWORD]<br>(C O D -) |
| SP14    |                                 |                               | 61                          |                                  |   |                            | 144                                   |                                     |                                  |                                      |                           |
| SP15    |                                 |                               | 62                          |                                  |   |                            | 144                                   |                                     |                                  |                                      |                           |
| SP16    |                                 |                               | 62                          |                                  |   |                            | 144                                   |                                     |                                  |                                      |                           |
| SPd     |                                 | 49, 51                        |                             |                                  |   |                            |                                       |                                     |                                  |                                      |                           |
| SPG     |                                 |                               | 54                          |                                  |   |                            |                                       |                                     |                                  |                                      |                           |
| SPn     |                                 |                               |                             |                                  |   |                            | 149                                   |                                     |                                  |                                      |                           |
| SPt     |                                 |                               |                             |                                  |   |                            | 179                                   |                                     |                                  |                                      |                           |
| SPrP    |                                 |                               | 62                          |                                  |   |                            | 148                                   |                                     |                                  |                                      |                           |
| SSb     |                                 |                               |                             |                                  |   |                            |                                       | 226                                 |                                  |                                      |                           |
| Std     |                                 |                               |                             |                                  |   |                            | 193                                   |                                     |                                  |                                      |                           |
| Stn     |                                 |                               |                             |                                  |   |                            |                                       | 221                                 |                                  |                                      |                           |
| StD     |                                 |                               |                             |                                  |   |                            |                                       | 226                                 |                                  |                                      |                           |
| StP     |                                 |                               |                             |                                  |   |                            |                                       | 221                                 |                                  |                                      |                           |
| St r    |                                 |                               |                             |                                  |   |                            | 146                                   |                                     |                                  |                                      |                           |
| St r t  |                                 |                               |                             |                                  |   |                            |                                       | 222                                 |                                  |                                      |                           |
| St t    |                                 |                               |                             |                                  |   |                            | 137                                   |                                     |                                  |                                      |                           |
| SUL     |                                 |                               |                             | 80                               |   |                            |                                       |                                     |                                  |                                      |                           |
| tA1     |                                 |                               | 53                          |                                  |   |                            | 135                                   |                                     |                                  |                                      |                           |
| tA2     |                                 |                               | 53                          |                                  |   |                            | 135                                   |                                     |                                  |                                      |                           |
| tA3     |                                 |                               | 53                          |                                  |   |                            | 135                                   |                                     |                                  |                                      |                           |
| tA4     |                                 |                               | 54                          |                                  |   |                            | 135                                   |                                     |                                  |                                      |                           |
| tAA     |                                 |                               |                             |                                  |   |                            | 182                                   |                                     |                                  |                                      |                           |
| tAC     |                                 | 49, 51                        |                             |                                  |   |                            |                                       |                                     |                                  |                                      |                           |
| tAr     |                                 |                               |                             |                                  |   |                            |                                       | 214                                 |                                  |                                      |                           |
| t b E   |                                 |                               | 63                          |                                  |   |                            | 158                                   |                                     |                                  |                                      |                           |
| t b D   |                                 |                               |                             |                                  |   |                            | 205                                   |                                     |                                  |                                      |                           |
| t b r   |                                 |                               |                             |                                  |   |                            |                                       | 236                                 |                                  |                                      |                           |
| t b r 2 |                                 |                               |                             |                                  |   |                            |                                       | 236                                 |                                  |                                      |                           |
| t b S   |                                 |                               |                             |                                  |   |                            |                                       | 221                                 |                                  |                                      |                           |
| t C C   | 39                              |                               |                             |                                  | 86                                      |                            |                                       |                                     |                                  |                                      |                           |
| t C t   |                                 |                               |                             |                                  | 86                                      |                            |                                       |                                     |                                  |                                      |                           |
| t d 1   |                                 |                               | 57                          |                                  |   |                            | 138                                   | 233                                 |                                  |                                      |                           |
| t d C   |                                 |                               | 57                          |                                  |   |                            | 138                                   | 233                                 |                                  |                                      |                           |
| t d C 1 |                                 |                               | 58                          |                                  |   |                            | 139                                   |                                     |                                  |                                      |                           |
| t d C 2 |                                 |                               | 58                          |                                  |   |                            | 140                                   |                                     |                                  |                                      |                           |
| t d n   |                                 |                               |                             |                                  |   |                            | 205                                   |                                     |                                  |                                      |                           |

# Index of parameter codes

| Code    | Page                            |                               |                             |                                  |  |                            |                                       |                                     |                                  |                                      |                           |
|---------|---------------------------------|-------------------------------|-----------------------------|----------------------------------|--|----------------------------|---------------------------------------|-------------------------------------|----------------------------------|--------------------------------------|---------------------------|
|         | [1.1 SIMPLY START]<br>(S I Π -) | [1.2 MONITORING]<br>(S U P -) | [1.3 SETTINGS]<br>(S E T -) | [1.4 MOTOR CONTROL]<br>(d r C -) | [1.5 INPUTS / OUTPUTS CFG]<br>( I - O -) | [1.6 COMMAND]<br>(C L L -) | [1.7 APPLICATION FUNCT.]<br>(F U n -) | [1.8 FAULT MANAGEMENT]<br>(F L T -) | [1.9 COMMUNICATION]<br>(C O Π -) | [1.12 FACTORY SETTINGS]<br>(F L 5 -) | [4 PASSWORD]<br>(C O d -) |
| ε d 5   |                                 |                               |                             |                                  |  |                            |                                       | 228                                 |                                  |                                      |                           |
| ε F 0   |                                 |                               |                             |                                  |  |                            |                                       |                                     | 236                              |                                      |                           |
| ε F 0 2 |                                 |                               |                             |                                  |  |                            |                                       |                                     | 236                              |                                      |                           |
| ε F r   | 40                              |                               | 68                          |                                  |  |                            |                                       |                                     |                                  |                                      |                           |
| ε H R   |                                 |                               |                             |                                  |  |                            |                                       | 218,<br>219                         |                                  |                                      |                           |
| ε H d   |                                 | 49, 51                        |                             |                                  |  |                            |                                       |                                     |                                  |                                      |                           |
| ε H r   |                                 | 49, 51                        |                             |                                  |  |                            |                                       |                                     |                                  |                                      |                           |
| ε H t   |                                 |                               |                             |                                  |  |                            |                                       | 217                                 |                                  |                                      |                           |
| ε L R   |                                 |                               |                             |                                  |  |                            | 182                                   |                                     |                                  |                                      |                           |
| ε L C   |                                 |                               |                             |                                  |  |                            | 183                                   |                                     |                                  |                                      |                           |
| ε L d   |                                 |                               |                             |                                  |  |                            |                                       | 230                                 |                                  |                                      |                           |
| ε L I G |                                 |                               | 64                          |                                  |  |                            | 182                                   |                                     |                                  |                                      |                           |
| ε L I Π |                                 |                               | 64                          |                                  |  |                            | 182                                   |                                     |                                  |                                      |                           |
| ε L 5   |                                 |                               | 60                          |                                  |  |                            | 176                                   |                                     |                                  |                                      |                           |
| ε n L   |                                 |                               |                             |                                  |  |                            |                                       | 231                                 |                                  |                                      |                           |
| ε 0 b   |                                 |                               |                             |                                  |  |                            | 180                                   |                                     |                                  |                                      |                           |
| ε 0 5   |                                 |                               |                             |                                  |  |                            | 168                                   |                                     |                                  |                                      |                           |
| ε 9 b   |                                 |                               |                             |                                  |  |                            |                                       | 228                                 |                                  |                                      |                           |
| ε r l   |                                 |                               |                             |                                  |  |                            | 179                                   |                                     |                                  |                                      |                           |
| ε r R   |                                 |                               |                             | 73                               |  |                            |                                       |                                     |                                  |                                      |                           |
| ε r C   |                                 |                               |                             |                                  |  |                            | 205                                   |                                     |                                  |                                      |                           |
| ε r H   |                                 |                               | 64                          |                                  |  |                            | 205                                   |                                     |                                  |                                      |                           |
| ε r L   |                                 |                               | 64                          |                                  |  |                            | 205                                   |                                     |                                  |                                      |                           |
| ε r Π   |                                 |                               |                             | 73                               |  |                            |                                       |                                     |                                  |                                      |                           |
| ε r P   |                                 |                               |                             |                                  |  |                            | 179                                   |                                     |                                  |                                      |                           |
| ε r r   |                                 | 49, 51                        |                             |                                  |  |                            |                                       |                                     |                                  |                                      |                           |
| ε r t   |                                 |                               |                             |                                  |  |                            | 179                                   |                                     |                                  |                                      |                           |
| ε 5 d   |                                 |                               |                             |                                  |  |                            | 179                                   |                                     |                                  |                                      |                           |
| ε 5 Π   |                                 |                               |                             |                                  |  |                            |                                       | 221                                 |                                  |                                      |                           |
| ε 5 5   |                                 |                               |                             |                                  |  |                            | 179                                   |                                     |                                  |                                      |                           |
| ε 5 t   |                                 |                               |                             |                                  |  |                            | 179                                   |                                     |                                  |                                      |                           |
| ε 5 Y   |                                 |                               |                             |                                  |  |                            | 206                                   |                                     |                                  |                                      |                           |
| ε t d   |                                 |                               | 65                          |                                  |  |                            |                                       | 217,<br>219                         |                                  |                                      |                           |
| ε t d 2 |                                 |                               |                             |                                  |  |                            |                                       | 217,<br>219                         |                                  |                                      |                           |

# Index of parameter codes

| Code    | Page                            |                               |                             |                                  |   |                            |                                       |                                     |                                  |                                      |                           |
|---------|---------------------------------|-------------------------------|-----------------------------|----------------------------------|---|----------------------------|---------------------------------------|-------------------------------------|----------------------------------|--------------------------------------|---------------------------|
|         | [1.1 SIMPLY START]<br>(S I P -) | [1.2 MONITORING]<br>(S U P -) | [1.3 SETTINGS]<br>(S E T -) | [1.4 MOTOR CONTROL]<br>(D R C -) | [1.5 INPUTS / OUTPUTS CFG]<br>(I - O -) | [1.6 COMMAND]<br>(C L L -) | [1.7 APPLICATION FUNCT.]<br>(F U n -) | [1.8 FAULT MANAGEMENT]<br>(F L T -) | [1.9 COMMUNICATION]<br>(C O M -) | [1.12 FACTORY SETTINGS]<br>(F L 5 -) | [4 PASSWORD]<br>(C O d -) |
| EE d 3  |                                 |                               |                             |                                  |   |                            |                                       | 217,<br>219                         |                                  |                                      |                           |
| EE H    |                                 |                               | 64                          |                                  |   |                            |                                       |                                     |                                  |                                      |                           |
| EE L    |                                 |                               | 64                          |                                  |   |                            |                                       |                                     |                                  |                                      |                           |
| EE 0    |                                 |                               |                             |                                  |   |                            |                                       | 236                                 |                                  |                                      |                           |
| EE r    |                                 |                               | 64                          |                                  |   |                            | 159                                   |                                     |                                  |                                      |                           |
| EU L    |                                 |                               |                             |                                  |   |                            | 199                                   |                                     |                                  |                                      |                           |
| EU n    | 41                              |                               |                             | 68                               |   |                            |                                       |                                     |                                  |                                      |                           |
| EU P    |                                 |                               |                             |                                  |   |                            | 205                                   |                                     |                                  |                                      |                           |
| EU 5    | 41                              |                               |                             | 68                               |   |                            |                                       |                                     |                                  |                                      |                           |
| U 0     |                                 |                               |                             | 70                               |   |                            |                                       |                                     |                                  |                                      |                           |
| U 1     |                                 |                               |                             | 70                               |   |                            |                                       |                                     |                                  |                                      |                           |
| U 2     |                                 |                               |                             | 70                               |   |                            |                                       |                                     |                                  |                                      |                           |
| U 3     |                                 |                               |                             | 70                               |   |                            |                                       |                                     |                                  |                                      |                           |
| U 4     |                                 |                               |                             | 70                               |   |                            |                                       |                                     |                                  |                                      |                           |
| U 5     |                                 |                               |                             | 70                               |   |                            |                                       |                                     |                                  |                                      |                           |
| U b r   |                                 |                               |                             | 82                               |   |                            |                                       |                                     |                                  |                                      |                           |
| U C 2   |                                 |                               |                             | 71                               |   |                            |                                       |                                     |                                  |                                      |                           |
| U C b   |                                 |                               |                             |                                  |   |                            |                                       | 215                                 |                                  |                                      |                           |
| U C P   |                                 |                               |                             | 71                               |   |                            |                                       |                                     |                                  |                                      |                           |
| U F r   |                                 |                               | 57                          | 72                               |   |                            |                                       |                                     |                                  |                                      |                           |
| U I H 1 |                                 |                               |                             |                                  | 91                                      |                            |                                       |                                     |                                  |                                      |                           |
| U I H 2 |                                 |                               |                             |                                  | 92                                      |                            |                                       |                                     |                                  |                                      |                           |
| U I H 4 |                                 |                               |                             |                                  | 94                                      |                            |                                       |                                     |                                  |                                      |                           |
| U I L 1 |                                 |                               |                             |                                  | 91                                      |                            |                                       |                                     |                                  |                                      |                           |
| U I L 2 |                                 |                               |                             |                                  | 92                                      |                            |                                       |                                     |                                  |                                      |                           |
| U I L 4 |                                 |                               |                             |                                  | 94                                      |                            |                                       |                                     |                                  |                                      |                           |
| U L n   |                                 | 49, 51                        |                             |                                  |   |                            |                                       |                                     |                                  |                                      |                           |
| U L r   |                                 |                               |                             |                                  |   |                            |                                       |                                     |                                  |                                      | 249                       |
| U n 5   | 40                              |                               | 67                          |                                  |   |                            |                                       |                                     |                                  |                                      |                           |
| U D H 1 |                                 |                               |                             |                                  | 108                                     |                            |                                       |                                     |                                  |                                      |                           |
| U D H 2 |                                 |                               |                             |                                  | 110                                     |                            |                                       |                                     |                                  |                                      |                           |
| U D H 3 |                                 |                               |                             |                                  | 111                                     |                            |                                       |                                     |                                  |                                      |                           |
| U D L 1 |                                 |                               |                             |                                  | 108                                     |                            |                                       |                                     |                                  |                                      |                           |
| U D L 2 |                                 |                               |                             |                                  | 110                                     |                            |                                       |                                     |                                  |                                      |                           |
| U D L 3 |                                 |                               |                             |                                  | 111                                     |                            |                                       |                                     |                                  |                                      |                           |

# Index of parameter codes

| Code           | Page                            |                               |                             |                                  |  |                            |                                       |                                     |                                  |                                      |                           |
|----------------|---------------------------------|-------------------------------|-----------------------------|----------------------------------|--|----------------------------|---------------------------------------|-------------------------------------|----------------------------------|--------------------------------------|---------------------------|
|                | [1.1 SIMPLY START]<br>(5 / П -) | [1.2 MONITORING]<br>(5 U P -) | [1.3 SETTINGS]<br>(5 E t -) | [1.4 MOTOR CONTROL]<br>(d r C -) | [1.5 INPUTS / OUTPUTS CFG]<br>( I - D -) | [1.6 COMMAND]<br>(C t L -) | [1.7 APPLICATION FUNCT.]<br>(F U n -) | [1.8 FAULT MANAGEMENT]<br>(F L t -) | [1.9 COMMUNICATION]<br>(C O n -) | [1.12 FACTORY SETTINGS]<br>(F L 5 -) | [4 PASSWORD]<br>(C O d -) |
| <i>UDP</i>     |                                 | 49, 51                        |                             |                                  |  |                            |                                       |                                     |                                  |                                      |                           |
| <i>UPL</i>     |                                 |                               |                             |                                  |  |                            |                                       | 221                                 |                                  |                                      |                           |
| <i>U r E 5</i> |                                 |                               |                             |                                  |  |                            |                                       | 221                                 |                                  |                                      |                           |
| <i>U S b</i>   |                                 |                               |                             |                                  |  |                            |                                       | 221                                 |                                  |                                      |                           |
| <i>U S l</i>   |                                 |                               |                             |                                  |  |                            | 148                                   |                                     |                                  |                                      |                           |
| <i>U S L</i>   |                                 |                               |                             |                                  |  |                            |                                       | 221                                 |                                  |                                      |                           |
| <i>U S P</i>   |                                 |                               |                             |                                  |  |                            | 146                                   |                                     |                                  |                                      |                           |
| <i>U S t</i>   |                                 |                               |                             |                                  |  |                            |                                       | 221                                 |                                  |                                      |                           |

